

Cl(16) Physics: E8 Lagrangian, Fr3(O) String Theory, and Cl(1,25) AQFT

Frank Dodd (Tony) Smith, Jr. - 2018



Abstract

Our Universe originated with Finkelstein Iteration of Real Clifford Algebras from the Void (First Grothendieck Universe) to Cl(16) (Second Grothendieck Universe) whose BiVectors and two quarter-Spinors (++ and --) give E8 Physics and whose TriVectors give Fr3(O) String Theory leading to a Cl(1,25) Algebraic Quantum Field Theory (AQFT) that generalizes Hyperfinite II1 von Neumann factor Fock Space from 2-Periodic Complex Clifford Algebra to 8-Periodic Real Clifford Algebra to get the Third Grothendieck Universe.

Table of Contents

Finkelstein Iteration of Clifford Algebras to Cl(16) ...	pages 2-4
Cl(16) BiVectors and two quarter-Spinors give E8 Physics ...	pages 5-14
Cl(16) TriVectors give Fr3(O) String Theory ...	pages 3-4 and 15-
26D World-Line=String Theory Construction ...	pages 19-22
Tachyons produce Schwinger Sources ...	page 23-29
Schwinger Source Green's Functions = Kernel Functions ...	pages 30-34
Schwinger Sources - BlockChain Indra's Net Jewels ...	pages 35-46
First Generation Fermion Geometry ...	pages 47-50
Second and Third Generation Fermions ...	pages 51-60
Kobayashi-Maskawa Parameters ...	pages 61-70
Neutrino Masses Beyond Tree Level ...	pages 71-75
Proton-Neutron Mass Difference ...	page 76
Pion as Sine-Gordon Breather ...	pages 78-81
Planck Mass as Superposition Fermion Condensate ...	page 82
Gauge Bosons and Force Strengths ...	pages 83-89
Higgs: W+, W-, Z0 and NJL Truth Quark-AntiQuark ...	pages 90-94
NJL Higgs Truth Quark-AntiQuark System ...	pages 95-98
LHC and Fermilab experimental results ...	pages 98-106
24x24 traceless symmetric matrices - Bohm Quantum Potential...	pages 107-131
Sarfatti-Bohm-Penrose-Hameroff Quantum Consciousness ...	pages 109-124
Cl(1,25) Algebraic Quantum Field Theory (AQFT) and Codes ...	pages 125-131
Results of Calculations ...	page 132-133
Ancient History ...	pages 134-154
Rig Veda / Angkor Wat ...	pages 134-136
Giza Pyramids Sphinx ...	pages 137-145
Cellular Automata ...	pages 146-154

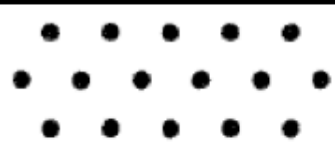
All Universes begin as Quantum Fluctuations of the Empty Set = Void by Quantum Fluctuation of Compact E8(-248) Real Form of E8 which is the First Grothendieck Universe and they all evolve according to David Finkelstein's Iteration of Real Clifford Algebras:

$n = 0$	\emptyset	= Void
$n = 1$	$\{\emptyset\}$	= Cl(0)
$n = 2$	$\emptyset \quad \{\emptyset\}$	= Cl(1)
$n = 4$	$\emptyset \quad \{\{\emptyset\}\} \quad \{\emptyset \& \{\emptyset\}\} \quad \{\emptyset\}$	= Cl(2)
$n = 16$		= Cl(4)
$n = 65,536$		= Cl($2^4=16$) = Cl(16)
$n = 2^{65,536}$		= Cl($2^{16}=65,536$) = Cl(65,536)

As the Finkelstein Iteration grows from the Void to Cl(0) to Cl(Cl(0)) to Cl(Cl ... n times ... Cl) the number of elements n grows from 0 to $2^0 = 1$ to $2^1 = 2$ to $2^2 = 4$ to $2^4 = 16$ to $2^{16} = 65,536$ to $2^{65,536}$... and beyond ...

so

it is clear that Cl(16) is the last stage of the process that is manageable for construction of a Physics Model based on Hereditarily Finite Sets which is the Second Grothendieck Universe.

What Structures of Cl(16) lead to a useful Physics Model ?

By 8-Periodicity of Real Clifford Algebras $Cl(16) = Cl(8) \times Cl(8)$ (where x = tensor product) so the graded structure of Cl(16) is

			1	
			16	
			120	
			560	
			1820	
			4368	
			8008	
			11440	
	1	1	12870	
	8	8	11440	
	28	28	8008	
	56	56	4368	
	70	70	1820	
TriVectors	56	56	560	$560 = 56 + 8 \times 28 + 28 \times 8 + 56$
BiVectors	28	28	120	$120 = 28 + 8 \times 8 + 28$
	8	8	16	
	1	1	1	
			Cl(8) x Cl(8) = Cl(16)	
			8-Periodicity tensor product	

Similarly, the Spinor structure of Cl(16) is

$$\mathbf{Cl(8) Spinors \times Cl(8) Spinors = Cl(16) Spinors}$$

8-Periodicity tensor product

$$\mathbf{Cl(8) \ 8 \ S^+ + 8 \ S^- \times \ Cl(8) \ 8 \ S^+ + 8 \ S^- =}$$

$$\mathbf{= Cl(16) \ 8 \times 8 \ S^{++} + 8 \times 8 \ S^{+-} + 8 \times 8 \ S^{-+} + 8 \times 8 \ S^{--}}$$

$$\mathbf{Cl(16) \ helicity \ consistent \ Spinors = 64 \ S^{++} + 64 \ S^{--} = 128}$$

Cl(16) is M256(R) = 256 x 256 Matrix Algebra of Real Numbers.

Cl(8) is M16(R) = 16 x 16 Matrix Algebra of Real Numbers.

BiVectors with an antisymmetric Bracket Product form a Lie Algebra.
 120-dim Cl(16) BiVectors + 128-dim Cl(16) half-Spinors = 248-dim E8

TriVectors with a symmetric Jordan Product form a Jordan Algebra.
 560-dim Cl(16) TriVectors = 10 copies of 56-dim Fr3(O)
 Fr3(O) = Complexification of 27-dim J3(O)

In terms of 16x16 Matrices of CI(8) and 256x256 Matrices of CI(16)
 (Matrices of Real Numbers. CI(8) TriVectors = 2-color dots with dark blue outer part.)

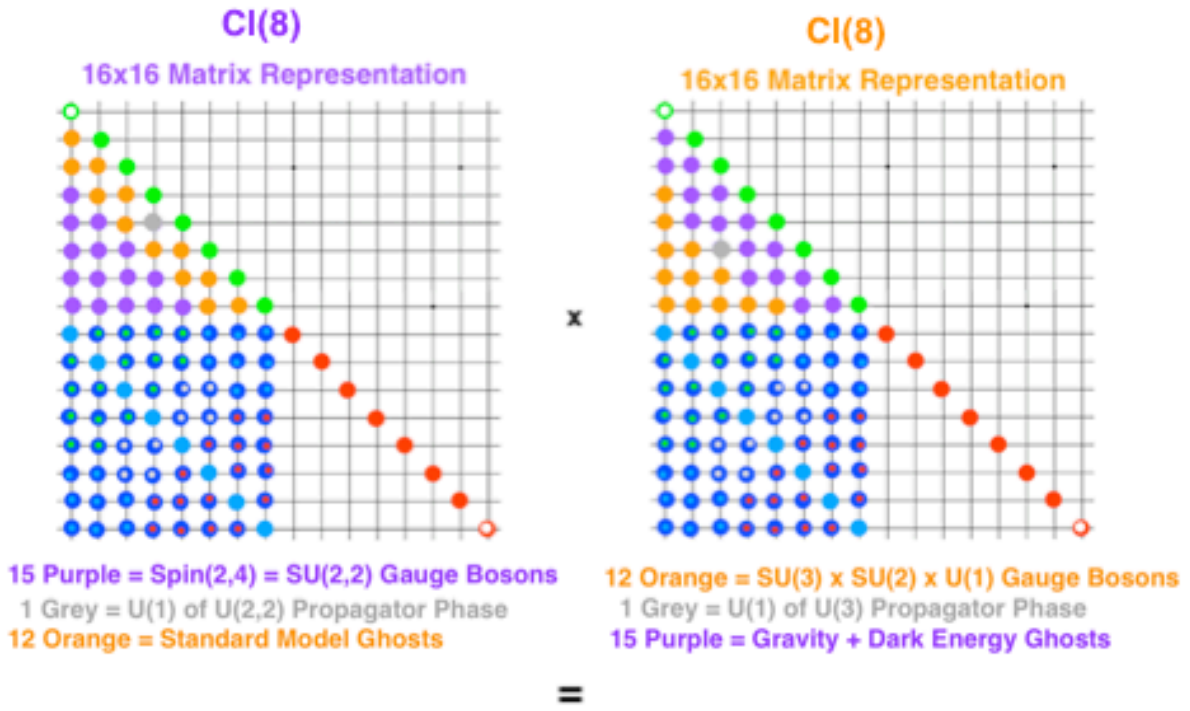

CI(16) 256x256 Matrix Representation

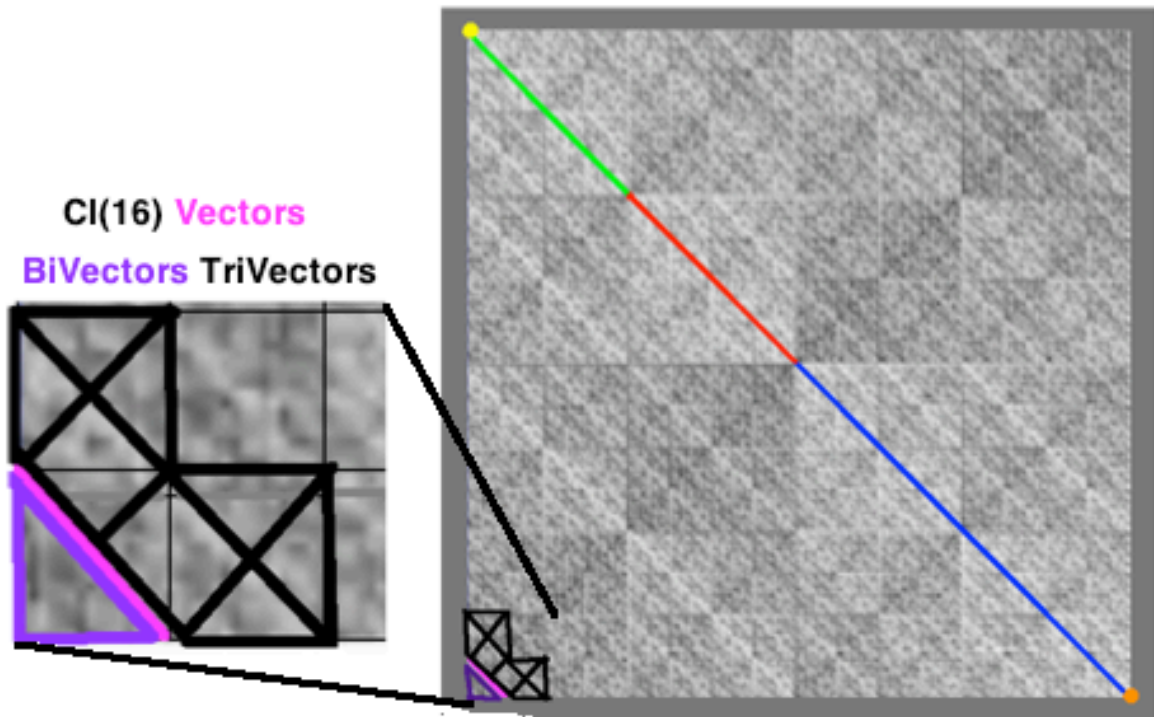

**Cl(16) BiVector + half-Spinor E8 structure of E8 gives
a Lagrangian for the Standard Model and Gravity + Dark Energy**
with 8D Spacetime = M4 x CP2 Kaluza-Klein (where CP2 = SU(3) / SU(2)xU(1)).

E8 / D8 = 128 = 64 + 64 =
8 components of 8 First Generation Fermion Particles +
+ 8 components of 8 First Generation Fermion AntiParticles
= Spinor Fermion terms of the Lagrangian Density

D8 / D4 x D4 = 64 = 8x8 =
8-dim Spacetime for Lagrangian Base Manifold x 8 Fermion Types
so that Spacetime is a superposition of 8-dim spaces,
one for each Fermion Type within which that Fermion Type propagates.

D4 = 28 = 16 + 12
where 16 = U(2,2) Conformal Group that gives Gravity + Dark Energy
as well as a U(1) propagator phase acting in M4 part of M4 x CP2
12 = M4 Ghosts of Standard Model Gauge Bosons

D4 = 28 = 12 + 16
where 12 = Standard Model Gauge Bosons acting in CP2 part of M4 x CP2
16 = CP2 Ghosts of Conformal U(2,2)

The 8D Lagrangian can be represented by the 240 Root Vectors of E8

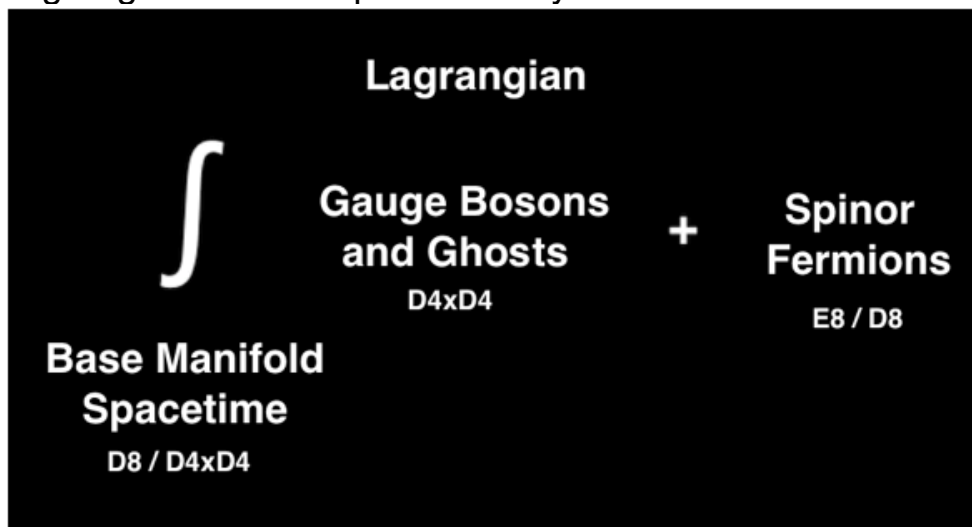

whose 8-dim Witting Polytope configuration

has been shown by Ray Aschheim in a 2-dim configuration

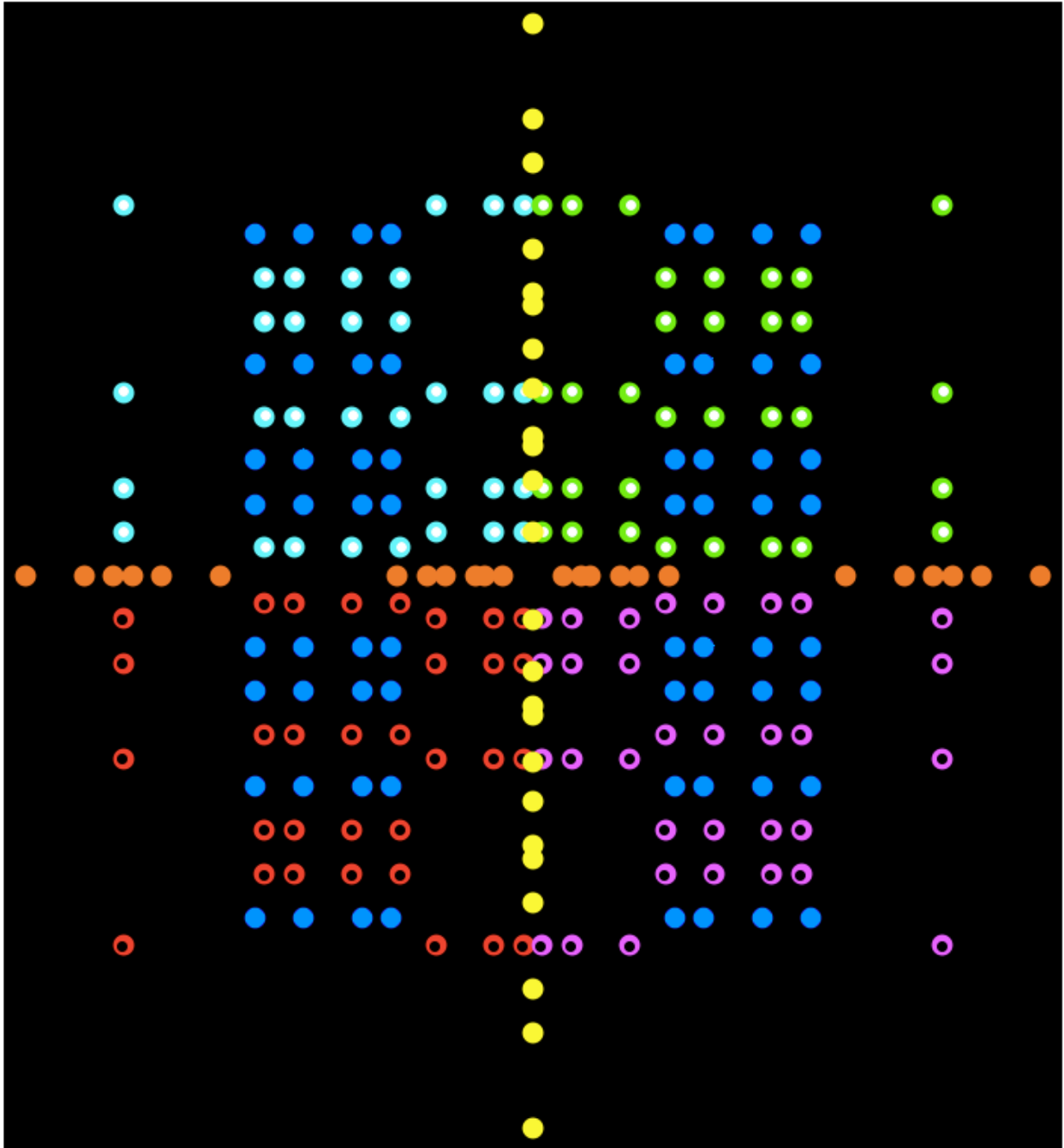

240 E8 Root Vectors = 112 D8 Root Vectors + 128 D8 half-spinors

128 D8 half-spinors = 128 elements of E8 / D8

Green and Cyan dots with white centers (32+32=64 dots) = Fermion Particles
Red and Magenta dots with black centers (32+32=64 dots) = Fermion AntiParticles

112 D8 Root Vectors = 64 D8 / D4xD4 (blue) + 24 D4 (yellow) + 24 D4 (orange)

The 64 Green and Cyan Root Vectors represent the
First Generation Fermion Particles of E8 / D8

Each of 8 Particles have

$8 = 4+4$ M4 x CP2 Kaluza-Klein components
so they are represented by $8 \times 8 = 64$ Root Vectors

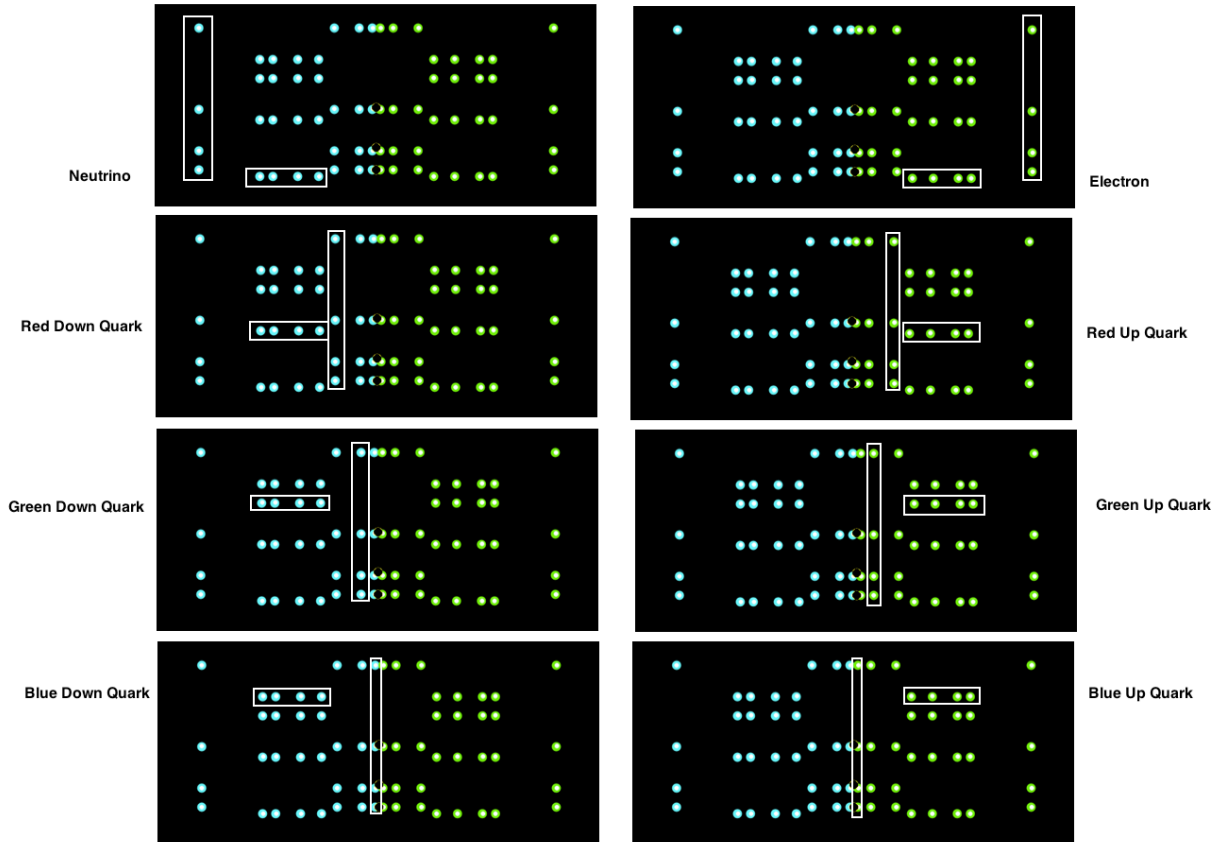

The 8 Fermion Particle Types $\{\text{Nu}, \text{rDQ}, \text{gDQ}, \text{bDQ}; \text{bUQ}, \text{gUQ}, \text{rUQ}, \text{E}\}$ are represented by the real part $\text{RP1} \times \text{S7}$ of the Complex Shilov Boundary S of the 32-real-dim V non-tube type.bounded Domain $(\text{CxO})\text{P2}$ of the EIII Symmetric Space $\text{E6} / \text{Spin}(10) \times \text{U}(1)$.

The bounded Domain is in a subspace of $\text{J3}(\text{CxO})$ and S is a fiber space with fiber $\text{RP1} \times \text{S7}$ (Real part for Particles) and base space S9 with fibration $\text{S1} \rightarrow \text{S9} \rightarrow \text{CP4}$ that contains a $\text{RP1} \times \text{S7}$ (for AntiParticles, in the Complex part) that is isomorphic to the fibre $\text{RP1} \times \text{S7}$ (Real part for Particles).

The 64 Red and Magenta Root Vectors represent the
First Generation Fermion AntiParticles of E8 / D8

Each of 8 AntiParticles have

$8 = 4+4$ M4 x CP2 Kaluza-Klein components
so they are represented by $8 \times 8 = 64$ Root Vectors

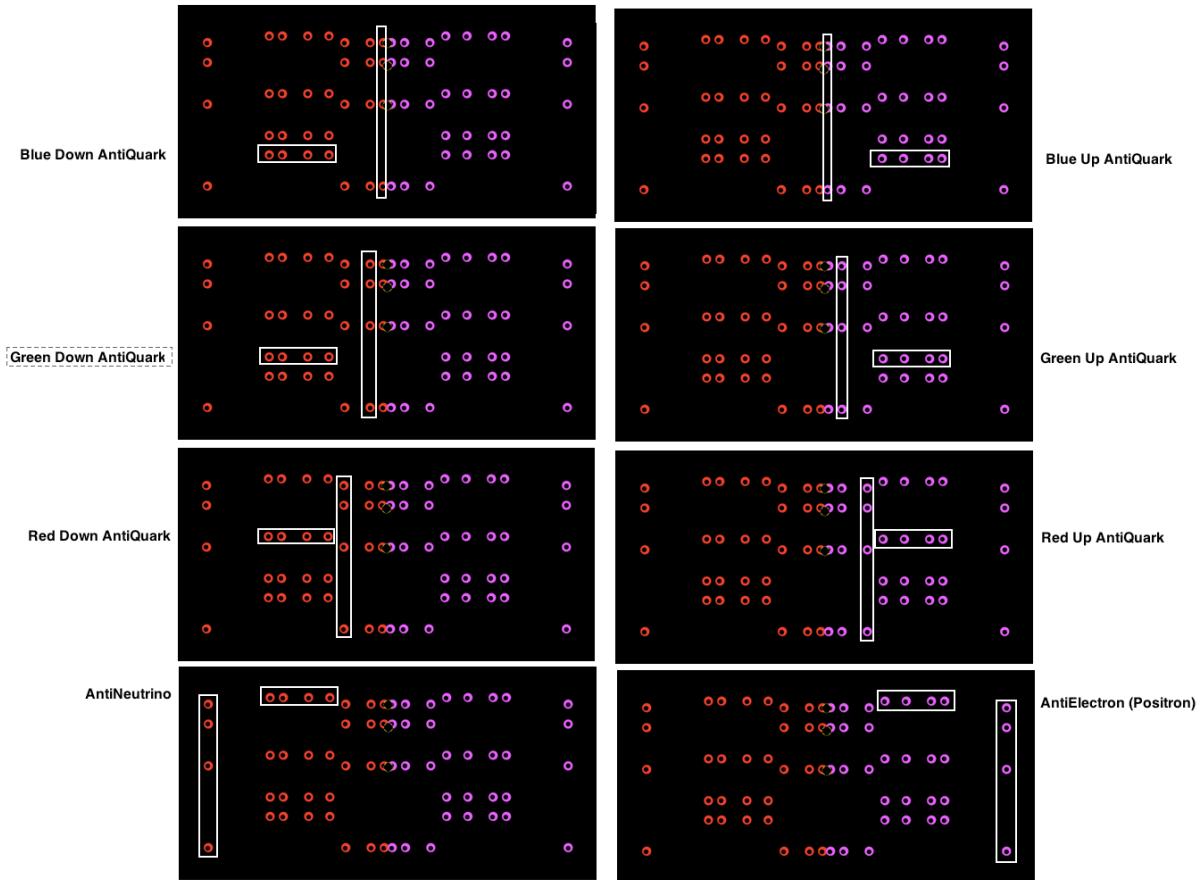

The 8 Fermion AntiParticle Types $\{\text{Nu}, \text{rDQ}, \text{gDQ}, \text{bDQ}; \text{bUQ}, \text{gUQ}, \text{rUQ}, \text{E}\}$
are represented by $\text{RP}1 \times \text{S}7$ in the Complex part of the Shilov Boundary S
of the 32-real-dim V non-tube type bounded Domain (CxO)P2 of the EIII
Symmetric Space $\text{E}6 / \text{Spin}(10) \times \text{U}(1)$.

The bounded Domain is in a subspace of $\text{J}3(\text{CxO})$ and S is a fiber space
with fiber $\text{RP}1 \times \text{S}7$ (Real part for Particles) and base space $\text{S}9$ with
fibration $\text{S}1 \rightarrow \text{S}9 \rightarrow \text{CP}4$ that contains a $\text{RP}1 \times \text{S}7$ (for AntiParticles,
in the Complex part) that is isomorphic to the fibre $\text{RP}1 \times \text{S}7$ (Real part for
Particles).

The 64 Blue Root Vectors of D8 / D4xD4 are a Superposition of 8 E8 Spacetime Lattices (7 being Integral Domains) corresponding to the 8 fundamental Fermion Types, each of which has 8-dim M4 x CP2 Kaluza-Klein structure. Effectively, each Fermion Type propagates within its own E8 Lattice within the Superposition forming an 8-dim Generalized Feynman Checkerboard

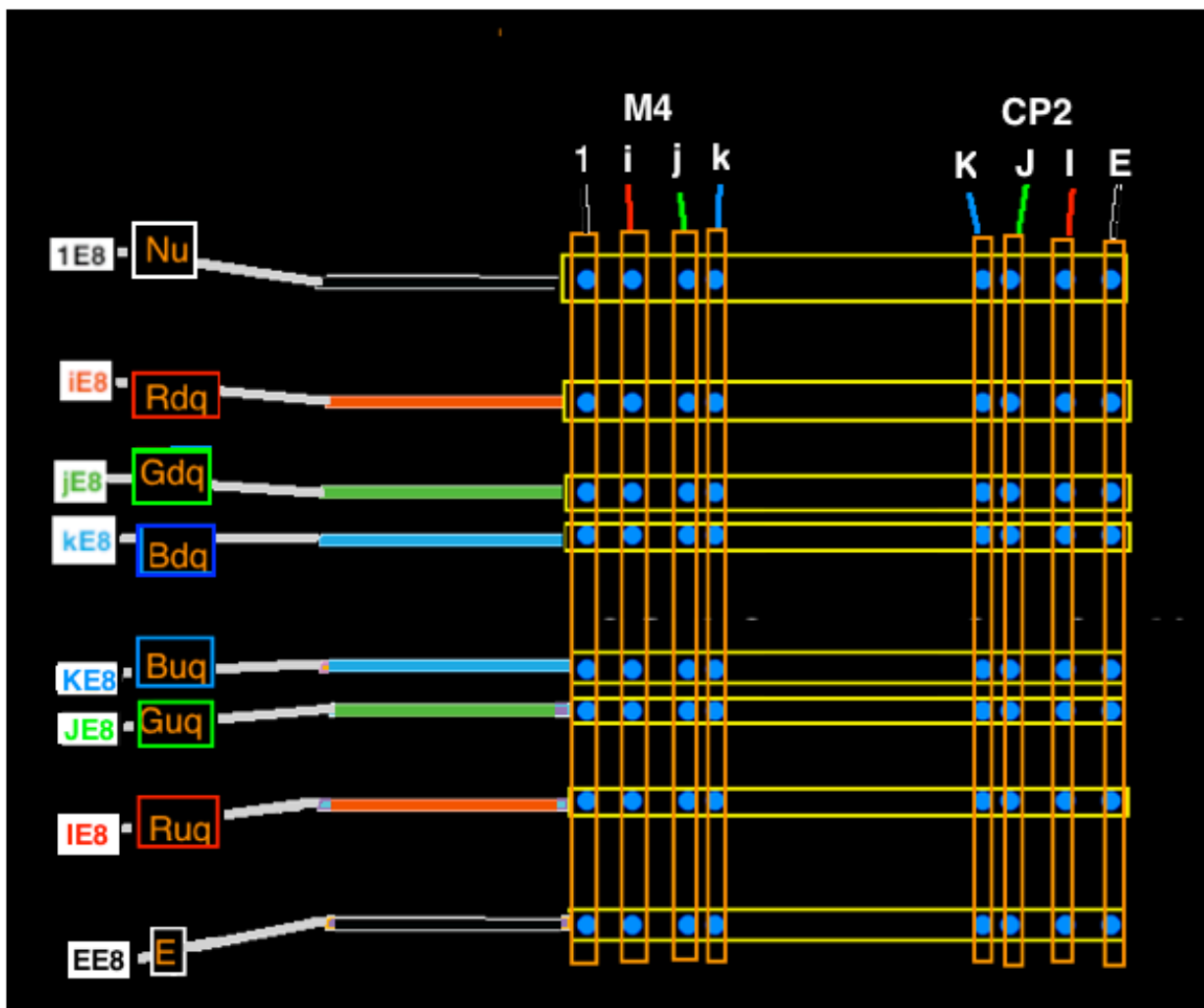

The 8 dimensions of M4xCP2 Spacetime $\{1, i, j, k, K, J, I, E\}$ are represented by the basis of the 8-real-dim space $RP^1 \times S^7$ that is the Shilov Boundary of the 16-real-dim $IV(8,2)$ Bounded Domain (tube type) of the BDI Symmetric Space $Spin(10) / Spin(8) \times U(1)$

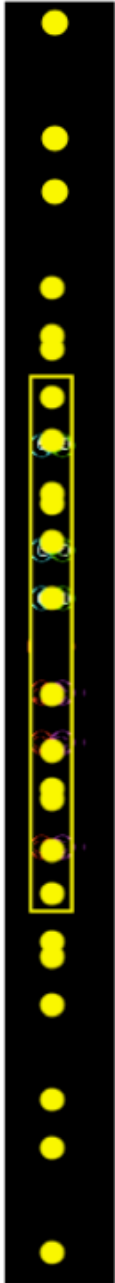

The 24 Yellow Root Vectors of the D4 of E8 Gravity + Standard Model Ghosts are on the Vertical Y-axis.

12 of them in the Yellow Box represent the 12 Root Vectors of the Conformal Gauge Group $SU(2,2) = Spin(2,4)$ of Conformal Gravity + Dark Energy. The 4 Cartan Subalgebra elements of $SU(2,2) \times U(1) = U(2,2)$ correspond to the 4 Cartan Subalgebra elements of D4 of E8 Gravity + Standard Model Ghosts and to the other half of the 8 Cartan Subalgebra elements of E8.

The other $24 - 12 = 12$ Yellow Root Vectors represent Ghosts of 12D Standard Model whose Gauge Groups are $SU(3) SU(2) U(1)$.

Gravity and Dark Energy come from its Conformal Subgroup $SU(2,2) = Spin(2,4)$
 - see Mohapatra "Unification and Supersymmetry section 14.6
 R. Aldrovandi and J. G. Peireira in gr-qc/9809061

$SU(2,2) = Spin(2,4)$ has 15 generators:

1 Dilation representing Higgs Ordinary Matter

4 Translations representing Primordial Black Hole Dark Matter

10 = 4 Special Conformal + 6 Lorentz representing Dark Energy
 (see Irving Ezra Segal, "Mathematical Cosmology and Extragalactic Astronomy" (Academic 1976))

The basic ratio Dark Energy : Dark Matter : Ordinary Matter = $10:4:1 = 0.67 : 0.27 : 0.06$
 When the dynamics of our expanding universe are taken into account, the ratio is calculated to be **0.75 : 0.21 : 0.04**

Ghosts correspond to Gauge Bosons:

Steven Weinberg in The Quantum Theory of Fields Volume II Section 15.7 said:
 "... there is a beautiful geometric interpretation of the ghosts and the BRST symmetry ...
 The gauge fields A_a^μ may be written as one-forms $A_a = A_{a\mu} dx^\mu$, where dx^μ are a set of anticommuting c-numbers. ... This can be combined with the ghost to compose a one-form $\mathbf{A}_a = A_a + w_a$ in an extended space.
 Also, the ordinary exterior derivative $d = dx^\mu \partial/\partial x^\mu$ may be combined with the BRST operator s to form an exterior derivative $D = d + s$ in this space, which is nilpotent because $s^2 = d^2 = sd + ds = 0 \dots$ ".

The 24 Orange Root Vectors of the D4 of E8 Standard Model + Gravity Ghosts are on the Horizontal X-axis.



8 of them in the Orange Box represent the 8 Root Vectors of the Standard Model Gauge Groups SU(3) SU(2) U(1).
 Their 4 Cartan Subalgebra elements correspond to the 4 Cartan Subalgebra elements of D4 of E8 Standard Model + Gravity Ghosts and to half of the 8 Cartan Subalgebra elements of E8.

The other 24-8 = 16 Orange Root Vectors represent Ghosts of 16D U(2,2) which contains the Conformal Group SU(2,2) = Spin(2,4) that produces Gravity + Dark Energy by the MacDowell-Mansouri mechanism.

Standard Model Gauge groups come from CP2 = SU(3) / SU(2) x U(1)
 (as described by Batakis in Class. Quantum Grav. 3 (1986) L99-L105)

Electroweak SU(2) x U(1) is gauge group as isotropy group of CP2.

SU(3) is global symmetry group of CP2 but due to Kaluza-Klein M4 x CP2 structure of compact CP2 at every M4 spacetime point, it acts as Color gauge group with respect to M4.

Ghosts correspond to Gauge Bosons:

Jean Thierry-Mieg in J. Math. Phys. 21 (1980) 2834-2838 said:

“... The ghost and the gauge field:

The single lines represent a local coordinate system of a principal fiber bundle of base space-time.

The double lines are 1 forms.

The connection of the principle bundle w is assumed to be vertical.

Its contravariant components Φ and X are recognized, respectively, as the Yang-Mills gauge field and the Faddeev-Popov ghost form ...

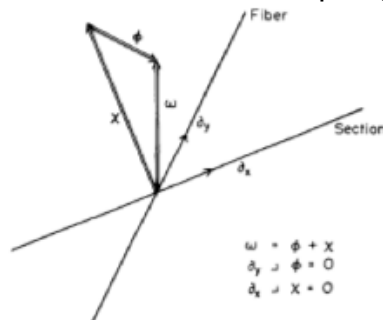

... ”

Here is how the 240 E8 Root Vectors fit into the 8D Lagrangian

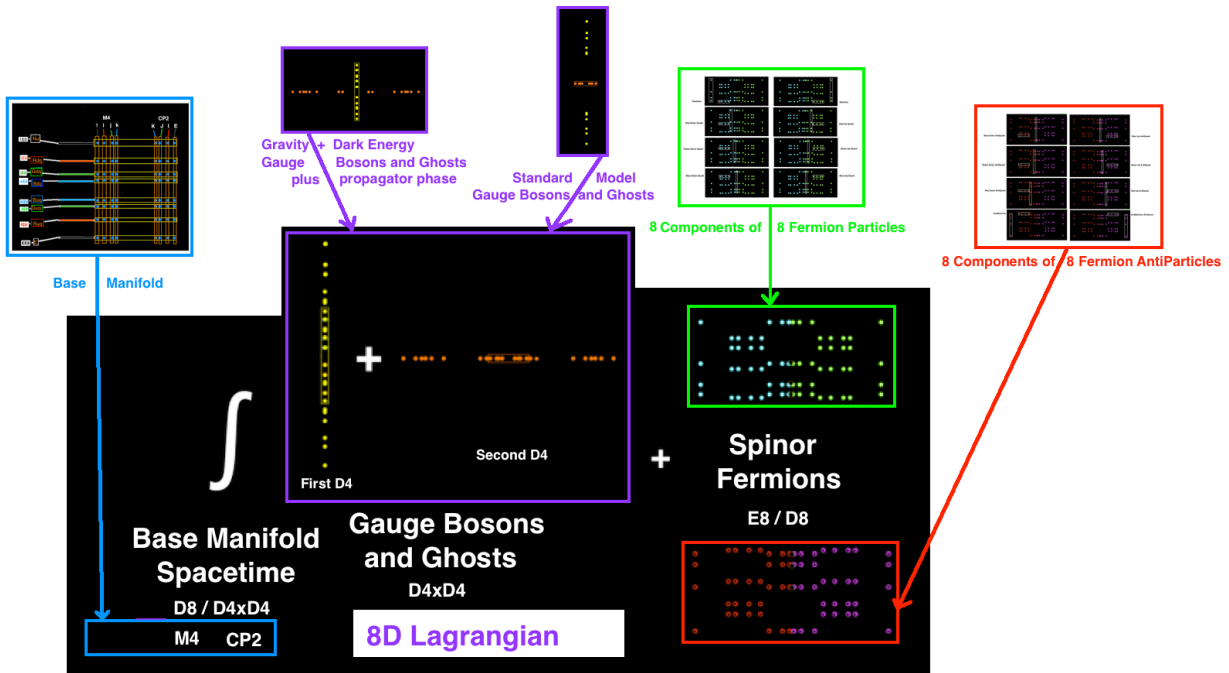

The Real Form of E8 at the Initial Big Bang is Compact E8(-248) with SO(16) Symmetry. The Real Form of E8 during Inflation is E8(8) with SO(8,8) Symmetry. In the 8D Lagrangian the Base Manifold Spacetime is 8-dim Octonion with respect to which Quantum Processes are Non-Unitary so that during Inflation Particles are created. After Inflation the Symmetry of Spacetime is broken from Octonion to Quaternion, the Real Form of E8 becomes E8(-24) with $SO^*(16) = Sk(8,H)$ Symmetry, and the Base Manifold Spacetime becomes M4 x CP2 Kaluza-Klein (where M4 = Minkowski and CP2 = SU(3) / SU(2)xU(1) = Internal Symmetry Space) Breaking Spacetime and World-Lines of Particles into M4 x CP2 Kaluza-Klein produces Higgs (Mayer and Trautman in Acta Physica Austriaca, Suppl. XXIII (1981)) and Fermion Generations 2 and 3 which produces a Nambu - Jona-Lasinio System of Higgs and Truth Quarks (Yamawaki et al in hep-ph/9603293 and hep-ph/0311165) that has Higgs as Truth Quark-AntiQuark condensate and 3 mass states:

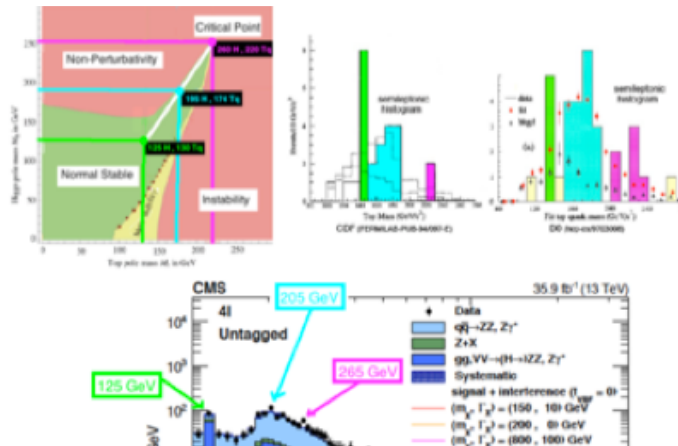

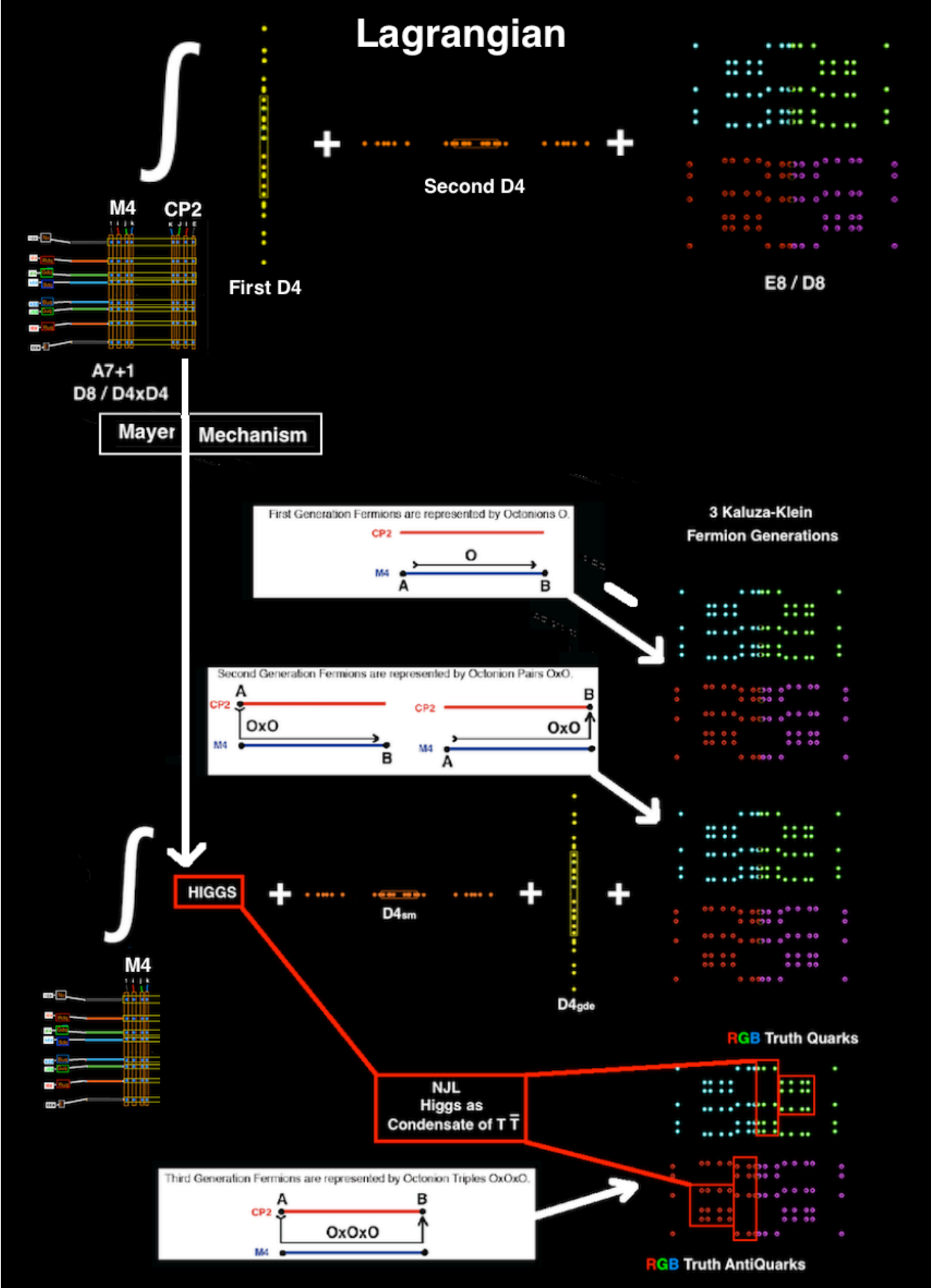

The 8D-4D E8 Lagrangian System has these characteristics:

Lagrangian has 8-dim Lorentz structure satisfying Coleman-Mandula because its Fermionic fundamental spinor representations are built with respect to spinor representations for 8-dim Spin(1,7) spacetime - see Steven Weinberg, "The Quantum Theory of Fields" Volume III

Lagrangian is UltraViolet finite because each Fermionic Term Fermion has in 8-dim Spacetime units of $\text{mass}^{(7/2)}$ and each Bosonic Gauge Boson + Ghost Term has units of $\text{mass}^{(1)}$, so, since $(8+8) \times (7/2) = 56 = 28 + 28$ the Fermionic Terms cancel the Bosonic Terms - see Steven Weinberg "1986 Dirac Lectures Elementary Particles and the Laws of Physics"

Lagrangian is Chiral because E8 contains Cl(16) half-spinors (64+64) for a Fermion Generation but does not contain Cl(16) Mirror Fermion AntiGeneration half-spinors. Fermion +half-spinor Particles with high enough velocity are seen as left-handed. Fermion -half-spinor AntiParticles with high enough velocity are seen as right-handed.

Lagrangian obeys Spin-Statistics because the CP2 part of M4xCP2 Kaluza-Klein has index structure Euler number $2+1 = 3$ and Atiyah-Singer index $-1/8$ which is not the net number of generations because CP2 has no spin structure but you can use a generalized spin structure (Hawking and Pope (Phys. Lett. 73B (1978) 42-44)) to get (for integral m) the generalized CP2 index $n_R - n_L = (1/2) m (m+1)$
Prior to Dimensional Reduction: $m = 1$, $n_R - n_L = (1/2) \times 1 \times 2 = 1$ for 1 generation
After Reduction to 4+4 Kaluza-Klein: $m = 2$, $n_R - n_L = (1/2) \times 2 \times 3 = 3$ for 3 generations
Hawking and Pope say: "Generalized Spin Structures in Quantum Gravity ... what happens in CP2 ... one could replace the electromagnetic field by a Yang-Mills field whose group G had a double covering $G\sim$. The fermion field would have to occur in representations which changed sign under the non-trivial element of the kernel of the projection ... $G\sim \rightarrow G$ while the bosons would have to occur in representations which did not change sign ...". For E8 physics gauge bosons are in the $28+28=56$ -dim D4xD4 subalgebra. D4 = SO(8) is the Hawking-Pope G with double covering $G\sim = \text{Spin}(8)$. The 8 fermion particles / antiparticles are D4 half-spinors represented within E8 by anti-commutators and so do change sign while the 28 gauge bosons are D4 adjoint represented within E8 by commutators and so do not change sign.

E8 Lagrangian inherits from F4 the property whereby its Spinor Part need not be written as Commutators but can also be written in terms of Fermionic AntiCommutators - see Pierre Ramond hep-th/0112261 -also, F4 lives in Cl(8) as Vectors + BiVectors + Spinors and by 8-Periodicity Cl(16) = tensor product Cl(8) x Cl(8) and E8 lives in Cl(16) as BiVectors + half-Spinors.

**Cl(16) TriVector Fr3(O) with J3(O)o structure gives
a 26D String Theory with World-Lines = Strings and
Tachyons to produce Schwinger Sources and
traceless spin-2 symmetric Bohm Quantum Potential**

The 560 TriVectors of Cl(16) with Jordan Product form 10 copies of the 56-dim Fr3(O) Freudenthal Algebra each of which contains two copies of the 27-dim J3(O) Jordan Algebra of 3x3 Hermitian Octonion matrices and therefore contains the complexification of 26-dim String Theory described by traceless J3(O)o

The complexification is necessary for representation of Fermions and Spacetime as E6 / D5 and D5 / D4 (instead of F4 / B4 and B4 / D4) thus giving Complex Bounded Domains and their Shilov Boundaries whose volumes are used in calculations of Force Strengths, Particle Masses, etc.

To see this, start with the 56 TriVectors of Cl(8) with Jordan Product that form the Freudenthal Algebra Fr3(O)

Fr3(O) is Zorn-type matrices
where
a,b,d,d',e,e',f,f' are Real Numbers
and
S+,S'+,V, V',S-,S'- are Octonions
and
* = Conjugate

$$\begin{array}{ccc}
 & & \begin{array}{ccc} d & S^+ & V \end{array} \\
 & & \begin{array}{ccc} S^{+*} & e & S^- \end{array} \\
 a & & \begin{array}{ccc} V^* & S^{-*} & f \end{array} \\
 \\
 \begin{array}{ccc} d' & S'^{+*} & V'^{*} \end{array} & & \\
 \begin{array}{ccc} S'^+ & e' & S'^{-*} \end{array} & & b \\
 \begin{array}{ccc} V' & S'^- & f' \end{array} & &
 \end{array}$$

and use the 16x16 Matrix Representation of $Cl(8)$ to see how the 56 $Cl(8)$ Trivector elements correspond to the 56 $Fr3(O)$ elements.

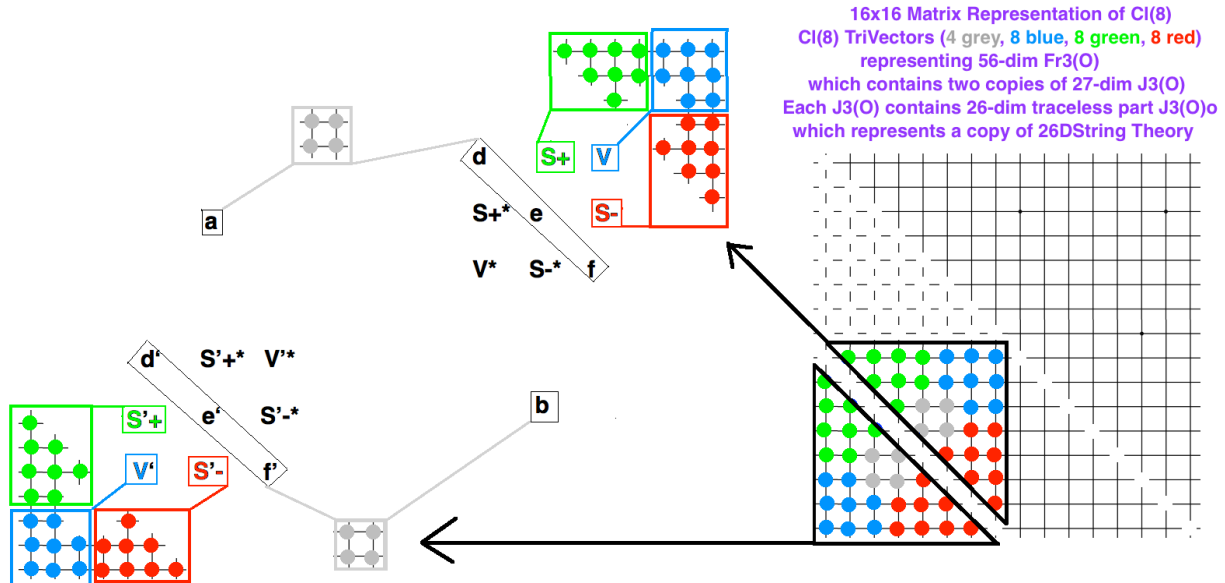

To see how $Fr3(O)$ gives String Theory look at one of the $J3(O)_o$ in $Fr3(O)$

d	S+	V
S+*	-d-f	S-
V*	S-*	f

One of the two 26D traceless $J3(O)_o$ parts of $Fr3(O)$

S+ = 8 First-Generation Fermion Particles
S- = 8 First-Generation Fermion AntiParticles

S+ and **S-** are Orbifolded in the 26D String Theory Space leaving $26 - 16 = 10$ dimensions of 8-dim **V** and 1-dim **d** and 1-dim **f**.

d and **f** act to make 10-dim **V+d+f** a Conformal Space over 8-dim **V** with Octonionic symmetries $Spin(1,9) = SL2(O)$ and $Spin(0,8) = Spin(1,7)$ due to the Clifford Algebra isomorphism $Cl(0,8) = Cl(1,7) = M16(R)$

At the level of 26D World-Line=String Theory $V+d+f = 10$ so that the String Spacetime is a Superposition of 10 E8 Lattices, 7 Integral Domains + 1 Kirmse's Mistake for V and two more E8 Lattices for Conformal d and f so that 560-dim $Cl(16)$ TriVectors = 10 copies of 56-dim $Fr3(O)$

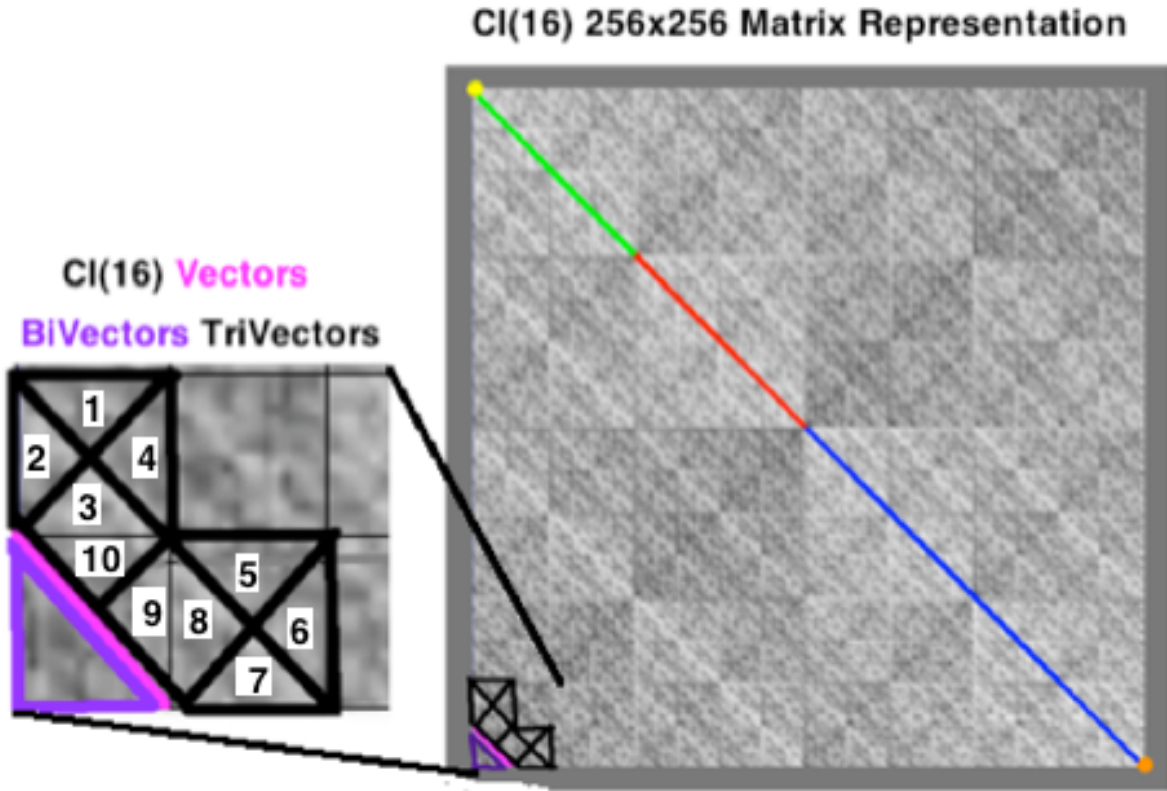

When Octonionic symmetry is broken to Quaternionic $Cl(0,8) = Cl(1,7) = M16(R)$ is broken to $Cl(2,6) = M8(H)$ which contains $Cl(2,4) = M4(H)$ with Conformal $Spin(2,4) = SU(2,2)$ so

the 10-dim $V+d+f$ breaks to $Cnf(2,4) + CP^2$ where $Cnf(2,4) = 6$ -dim Vector Space of Conformal $Cl(2,4)$ and $CP^2 = SU(3) / SU(2) \times U(1) =$ Compact Internal Symmetry Space carrying the Gauge Group symmetries of the Standard Model.

By Twistor Correspondences 6-dim Vector Space of Conformal $Cl(2,4)$ contains 4-dim $M4$ Minkowski Physical Spacetime so that our experiments see Spacetime as Kaluza-Klein $M4 \times CP^2$ and 8-dim V is effectively $M4 \times CP^2$ Kaluza-Klein.

In this Physics Model, with Fermions propagating in Spacetime,

Strings are physically interpreted as World-Lines, according to David Finkelstein's idea ("Space-Time Code. III" Phys. Rev. D (1972) 2922-2931)
"... According to relativity, the world is a collection of processes (events) with an unexpectedly unified causal or chronological structure. Then an object is secondary ... [to]... a long causal sequence of processes, world line. ... [if] we assemble these ... into chromosomelike code sequences ... and braid and cross-link these strands to make more complex objects and their interactions ...[then]... The idea of the quantum jump comes into its own, and reigns supreme, even over space and time. ...".

Andrew Gray (quant-ph/9712037v2) said:

"... A new formulation of quantum mechanics ... assign[s] ... probabilities ... to entire fine-grained histories ... [It] is fully relativistic and applicable to multi-particle systems ...[and]... makes the same experimental predictions as quantum field theory ... consider space and time cut up into small volume elements ... and then take the limit as ... volume ... $\rightarrow 0$... get the final amplitude ... by considering all possible distributions at a time t earlier ... for each such distribution the amplitude for it to occur [is] multiplied by the amplitude to get ... the final distribution ... **the interference factor ... is a measure of how much interference between the different possible histories that contain the distribution of interest there is at each time** ... This result is the ... **Feynman amplitude squared times the product of all the interference factors ...**".

Luis E. Ibanez and Angel M. Uranga in "String Theory and Particle Physics" said:

"... String theory proposes ... small one-dimensional extended objects, strings, of typical size $L_s = 1/M_s$, with M_s known as the string scale ... As a string evolves in time, it sweeps out a two-dimensional surface in spacetime, known as the worldsheet, which is the analog of the ... worldline of a point particle ... for the bosonic string theory ... the classical string action is the total area spanned by the worldsheet ... This is the ... Nambu- Goto action ...".

Consider the Gray Fine-Grained History to be a World-Line String.



The Gray Fine-Grained History Quantum Theory is equivalent to the Nambu-Goto action of 26D String Theory.
Nambu-Goto 24x24 traceless spin-2 particle is Quantum Bohmion carrier of Bohm Quantum Potential

Further, Ibanez and Uranga also said:

“... The string groundstate corresponds to a 26d spacetime tachyonic scalar field $T(x)$. This **tachyon** ... is ... unstable

...

The massless two-index tensor splits into irreducible representations of $SO(24)$... Its **trace** corresponds to a scalar field, the **dilaton** ϕ , whose vev fixes the string interaction coupling constant g_s

...

the **antisymmetric** part is the 26d 2-form field BMN

...

The **symmetric traceless** part is ... 26d ...”.

Dilatons are Goldstone bosons of spontaneously broken scale invariance that (analogous to Higgs) go from mediating a long-range scalar gravity-type force to the nonlocality of the Bohm-Sarfatti Quantum Potential.

The **antisymmetric** $SO(24)$ little group is related to the Monster automorphism group that is the symmetry of each cell of Planck-scale local lattice structure.

Joe Polchinski in “String Theory, Volume 1, An Introduction to the Bosonic String” said: “... we find at $m^2 = -4/\alpha'$ the **tachyon**, and at $m^2 = 0$ the 24×24 states of the [**traceless symmetric tensor**], **dilaton**, and **antisymmetric tensor** ...”.

Here is how the 26D World-Line=String Theory is constructed

Step 1:

Consider the 26 Dimensions of Bosonic String Theory as a 26-dimensional traceless part $J_3(O)$ living inside a $Fr_3(O)$

a O_+ O_v

O_+^* b O_-

O_v^* O_-^* -a-b

(where O_v , O_+ , and O_- are in Octonion space with basis $\{1, i, j, k, E, I, J, K\}$ and a and b are real numbers with basis $\{1\}$) of the 27-dimensional Jordan algebra $J_3(O)$ of 3×3 Hermitian Octonion matrices.

Step 2:

Take a 3-brane to correspond to the Imaginary Quaternionic associative subspace spanned by $\{i, j, k\}$ in the 8-dimensional Octonionic O_v space.

Step 3:

Compactify the 4-dimensional co-associative subspace spanned by {E,I,J,K} in the Octonionic Ov space as a CP2 = SU(3)/U(2), with its 4 world-brane scalars corresponding to the 4 covariant components of a Higgs scalar.

Add this subspace to the 3-brane, to get a 7-brane.

Step 4:

Orbifold the 1-dimensional Real subspace spanned by {1} in the Octonionic Ov space by the discrete multiplicative group Z2 = {-1,+1}, with its fixed points {-1,+1} corresponding to past and future time. This discretizes time steps and gets rid of the world-brane scalar corresponding to the subspace spanned by {1} in Ov. It also gives our brane a 2-level timelike structure, so that its past can connect to the future of a preceding brane and its future can connect to the past of a succeeding brane.

Add this subspace to the 7-brane, to get an 8-brane Spacetime Superposition.

Our basic 8-brane looks like two layers (past and future) of 7-branes.

Beyond the 8-brane our String Theory has 26 - 8 = 18 dimensions, of which 25 - 8 = 17 have corresponding world-brane scalars:

8 world-brane scalars for Octonionic O+ space;

8 world-brane scalars for Octonionic O- space;

1 world-brane scalars for real a space;

and 1 dimension, for real b space, in which 8-branes containing spacelike 3-branes are stacked in timelike order.

Step 5:

To get rid of the world-brane scalars corresponding to the Octonionic O+ space, orbifold it by the 16-element discrete multiplicative group

$$\text{Oct16} = \{+/-1, +/-i, +/-j, +/-k, +/-E, +/-I, +/-J, +/-K\}$$

to reduce O+ to 16 singular points {-1,-i,-j,-k,-E,-I,-J,-K,+1,+i,+j,+k,+E,+I,+J,+K}.

Let the 8 O+ singular points {-1,-i,-j,-k,-E,-I,-J,-K} correspond to the fundamental fermion particles

{neutrino, red up quark, green up quark, blue up quark, electron, red down quark, green down quark, blue down quark} located on the past 7-brane layer of the 8-brane.

Let the 8 O+ singular points {+1,+i,+j,+k,+E,+I,+J,+K} correspond to the fundamental fermion particles

{neutrino, red up quark, green up quark, blue up quark, electron, red down quark, green down quark, blue down quark} located on the future 7-brane layer of the 8-brane.

The 8 components of the 8 fundamental first-generation fermion particles = 8x8 = 64 correspond to the 64 of the 128-dim half-spinor 8-brane part of E8.

This gets rid of the 8 world-brane scalars corresponding to O+, and leaves:

8 world-brane scalars for Octonionic O- space;

1 world-brane scalars for real a space;

and 1 dimension, for real b space, in which 8-branes containing spacelike 3-branes are stacked in timelike order.

Step 6:

To get rid of the world-brane scalars corresponding to the Octonionic O- space, orbifold it by the 16-element discrete multiplicative group

$$\text{Oct16} = \{+/-1, +/-i, +/-j, +/-k, +/-E, +/-I, +/-J, +/-K\}$$

to reduce O- to 16 singular points $\{-1, -i, -j, -k, -E, -I, -J, -K, +1, +i, +j, +k, +E, +I, +J, +K\}$.

Let the 8 O- singular points $\{-1, -i, -j, -k, -E, -I, -J, -K\}$ correspond to the fundamental fermion anti-particles {anti-neutrino, red up anti-quark, green up anti-quark, blue up anti-quark, positron, red down anti-quark, green down anti-quark, blue down anti-quark} located on the past 7-brane layer of D8.

Let the 8 O- singular points $\{+1, +i, +j, +k, +E, +I, +J, +K\}$ correspond to the fundamental fermion anti-particles {anti-neutrino, red up anti-quark, green up anti-quark, blue up anti-quark, positron, red down anti-quark, green down anti-quark, blue down anti-quark} located on the future 7-brane layer of the 8-brane.

The 8 components of 8 fundamental first-generation fermion anti-particles = $8 \times 8 = 64$ correspond to the 64 of the 128-dim half-spinor 8-brane part of E8.

This gets rid of the 8 world-brane scalars corresponding to O-, and leaves:

1 world-brane scalars for real a space;

and

1 dimension, for real b space, in which 8-branes containing spacelike 3-branes are stacked in timelike order.

Step 7:

Let the 1 world-brane scalar for real a space correspond to a Bohm-type Quantum Potential acting on strings in the stack of 8-branes.

Interpret strings as world-lines in the Many-Worlds, short strings representing virtual particles and loops.

Step 8:

Fundamentally, physics is described on HyperDiamond Lattice structures.

There are 7 independent E8 lattice Integral Domains, each corresponding to one of the 7 imaginary octonions. denoted by $iE8, jE8, kE8, EE8, IE8, JE8,$ and $KE8$ and related to 8-brane adjoint and half-spinor parts of E8 and with 240 first-shell vertices.

An 8th 8-dim lattice $1E8$ (not an Integral Domain) with 240 first-shell vertices related to the E8 adjoint part of E8 is related to the 7 octonion imaginary lattices.

Give each 8-brane structure based on Planck-scale E8 lattices so that each 8-brane is a superposition/intersection/coincidence of the eight E8 lattices.

(see viXra 1301.0150)

Step 9:

Since Polchinski says "... If r D-branes coincide ... there are r^2 vectors, forming the adjoint of a $U(r)$ gauge group ...", make the following assignments:

a gauge boson emanating from the 8-brane from its $1E_8$ and EE_8 lattices is an $SU(2) \times U(1)$ ElectroWeak boson accounting for the photon and W^+ , W^- and Z_0 bosons.

a gauge boson emanating from the 8-brane from its IE_8 , JE_8 , and KE_8 lattices is a $SU(3)$ Color Gluon boson thus accounting for the 8 Color Force Gluon bosons.

The $4+8 = 12$ bosons of the Standard Model Electroweak and Color forces correspond to 12 of the 28 dimensions of 28-dim $Spin(8)$ that corresponds to one of the 28 of the 120-dim adjoint 8-brane parts of E_8 .

a gauge boson emanating from the 8-brane from its $1E_8$, iE_8 , jE_8 , and kE_8 lattices is a $U(2,2)$ boson for conformal $U(2,2) = Spin(2,4) \times U(1)$ MacDowell-Mansouri gravity plus conformal structures consistent with the Higgs mechanism and with observed Dark Energy, Dark Matter, and Ordinary matter.

The 16-dim $U(2,2)$ is a subgroup of 28-dim $Spin(2,6)$ that corresponds to the other 28 of the 120-dim adjoint 8-brane part of E_8 .

Step 10:

Since Polchinski says

"... there will also be r^2 massless scalars from the components normal to the D-brane. ... the collective coordinates ... X^u ... for the embedding of n D-branes in spacetime are now enlarged to $n \times n$ matrices. This 'noncommutative geometry' ...[may be]... an important hint about the nature of spacetime. ...",

make the following assignment:

The 8×8 matrices for the collective coordinates linking an 8-brane to the next 8-brane in the stack are needed to connect the eight E_8 lattices of the 8-brane to the eight E_8 lattices of the next 8-brane in the stack. The $8 \times 8 = 64$ correspond to the 64 of the 120 adjoint 8-brane part of E_8 .

We have now accounted for all the scalars and have shown that the model has the physics content of the realistic E_8 Physics model with Lagrangian structure based on $E_8 = (28 + 28 + 64) + (64 + 64)$ and AQFT structure based on $Cl(1,25)$ with real Clifford Algebra periodicity and generalized Hyperfinite II1 von Neumann factor algebra.

**Tachyons localized at orbifolds of fermions
produce virtual clouds of particles / antiparticles that dress fermions
and so produce Schwinger Sources.**

When a fermion particle/antiparticle appears in E8 spacetime it does not remain a single Planck-scale entity because **Tachyons create a cloud of particles/antiparticles**. The cloud is one Planck-scale Fundamental Fermion Valence Particle plus an effectively neutral cloud of particle/antiparticle pairs forming a Kerr-Newman black hole. That cloud constitutes the **Schwinger Source**. Its **structure comes from the 24-dim Leech lattice part of the Monster Group which is**

$2^{(1+24)}$ times the double cover of Co_1 , for a total order of about 10^{26} .

Since a Leech lattice is based on copies of an E8 lattice and since there are 7 distinct E8 integral domain lattices there are 7 (or 8 if you include a non-integral domain E8 lattice) distinct Leech lattices. The physical Leech lattice is a superposition of them, effectively adding a factor of 8 to the order.

The volume of the Kerr-Newman Cloud is on the order of 10^{27} x Planck scale, so the Kerr-Newman Cloud **Source should contain about 10^{27} particle/antiparticle pairs and its size should be about $10^{(27/3)} \times 1.6 \times 10^{(-33)}$ cm = roughly $10^{(-24)}$ cm.**

Schwinger Source QuasiCrystal Internal Structure

Above the scale of Schwinger Sources ($10^{(-24)}$ cm) E8-Cl(16) Physics structures such as Spacetime, Symmetric Spaces, and Bounded Complex Domains and their Shilov Boundaries, are well approximated by smooth manifolds so that the geometric techniques of Amand Wyler give good results for force strengths, particle masses, etc.

Below the scale of Schwinger Sources ($10^{(-24)}$ cm down to Planck $10^{(-33)}$ cm) the fundamental structures are E8 lattices and QuasiCrystals derived therefrom. Planck Scale is about $10^{(-33)}$ cm. Schwinger Source Scale is about $10^{(-24)}$ cm, a scale about 10^9 larger than the Planck Scale.

This mapping of the shell structure of a full E8 Lattice
is adapted from the book "Geometrical Frustration" by Sadoc and Mosseri

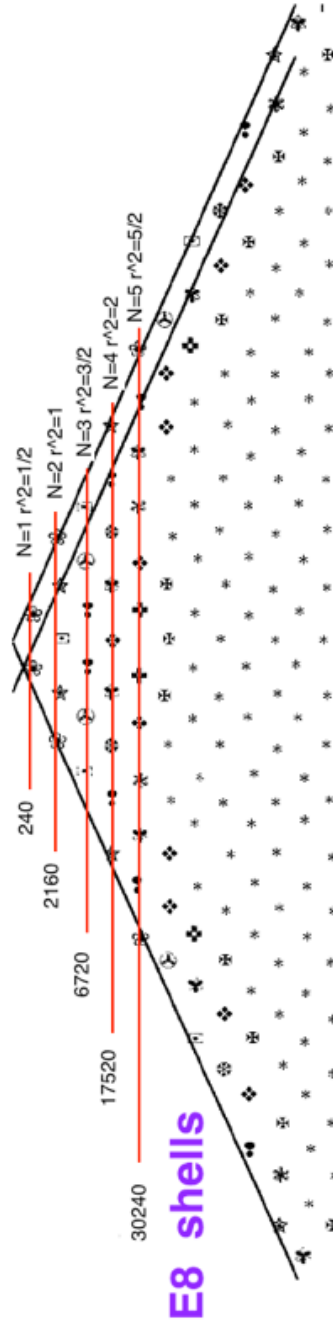

E8 shells

- ☉ {335} ☐ "720" ⚬ "1440" ⬠ "3600" ⬢ "3840" ✖ "7200"
- ★ {533} Ⓞ "1200" ⚬ "2400" Ⓞ "2400" + {335} ⚬ "3600" + {335} * "not determined"

$120+1440+2400+(3600+120)+3600+3840+3840+(3600+120)+2400+1440+120 = 30240$
 $600+1440+(2400+120)+2400+3600+2400+(2400+120)+1440+600 = 17520$
 $720+1200+1440+1440+1200+720 = 6720$
 $120+600+720+600+120 = 2160$
 $120+120 = 240$

How to Visualize a Schwinger Source in 7 Steps:

First, look at the 240-vertex E8 Root Vector representation of the Valence Fermion of the Schwinger Source Cloud. It is two 600-cells, each with 120 vertices:

H4 M4 representing Conformal Gravity and the M4 part of M4 x CP2 Kaluza-Klein
 where M4 = 4D Minkowski Physical Spacetime and
 H4 CP2 representing the Standard Model and the CP2 part of M4 x CP2
 where CP2 = SU(3) / SU(2) x U(1) Internal Symmetry Space

The H4 M4 600-cell is larger than the H4 CP2 600-cell by the Golden Ratio

E8 240 Root Vectors =

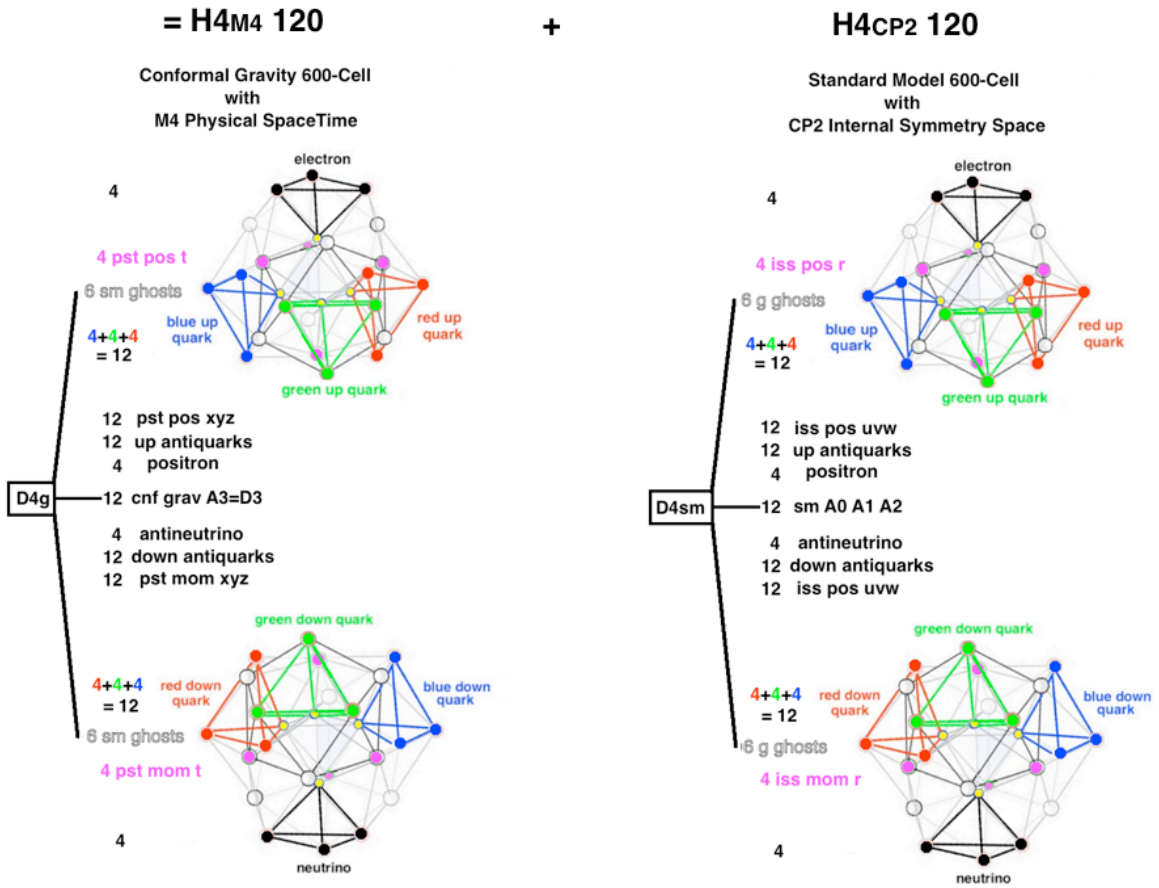

Each First-Generation Fermion is represented by a 4-vertex Tetrahedron in the H4 M4 600-cell and in the H4 CP2 600-cell.

**The Valence Fermion is represented as
 the corresponding two Tetrahedra being activated.**

Second, look only at the H4 M4 600-cell to see how the Valence Fermion looks in M4 Minkowski Physical Spacetime:

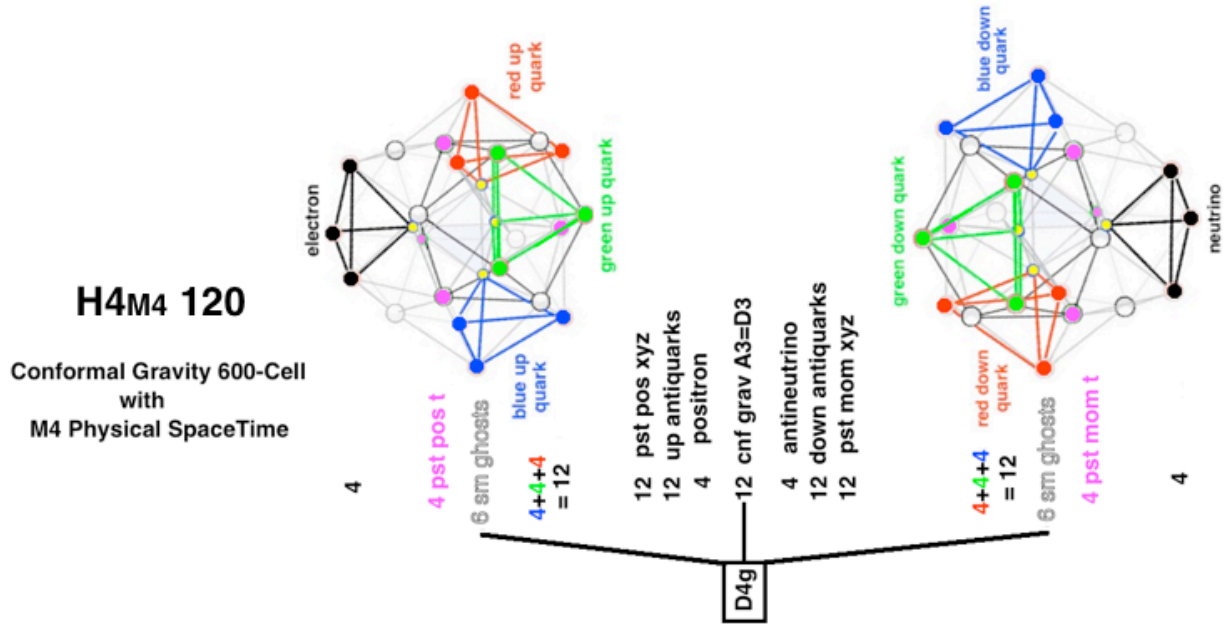

Third, look at the Fibonacci Shell Structure of the M4 part of the Schwinger Source Cloud

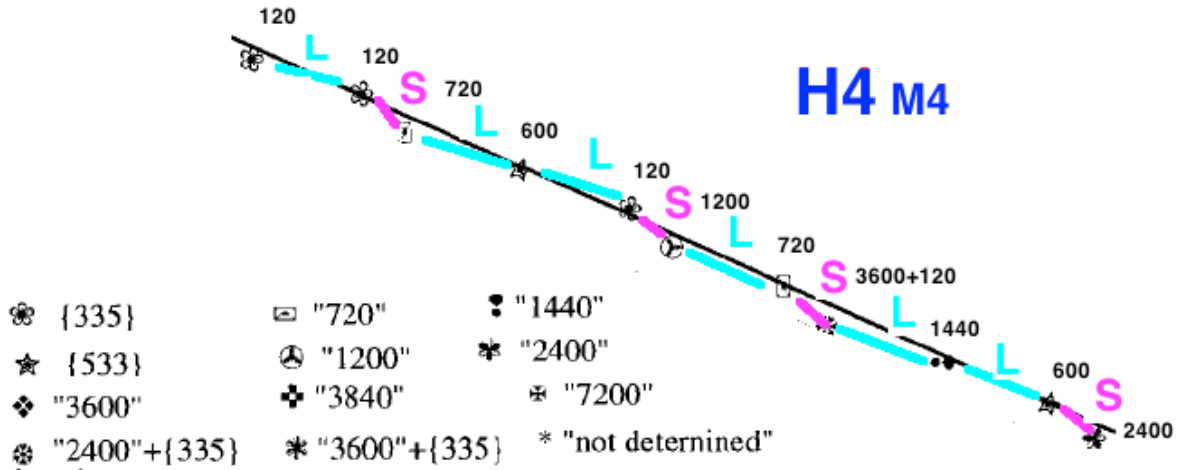

Fourth, look only at the H4 CP2 600-cell to see how the Valence Fermion looks in CP2 Internal Symmetry Space:

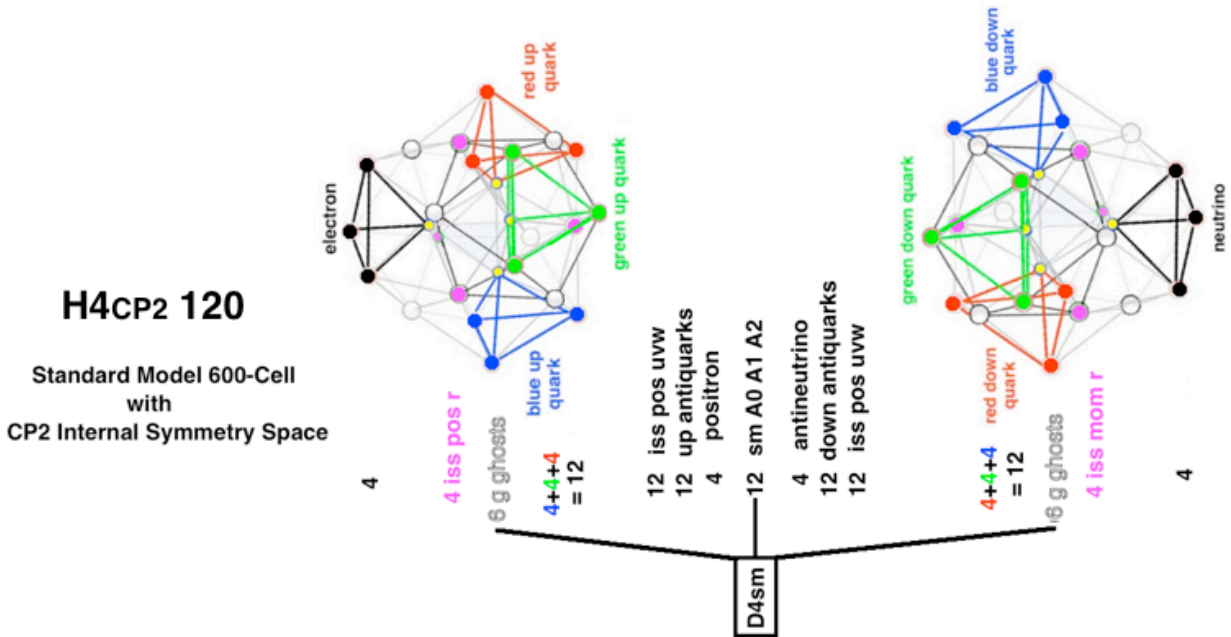

Fifth, look at the Fibonacci Shell Structure of the CP2 part of the Schwinger Source Cloud

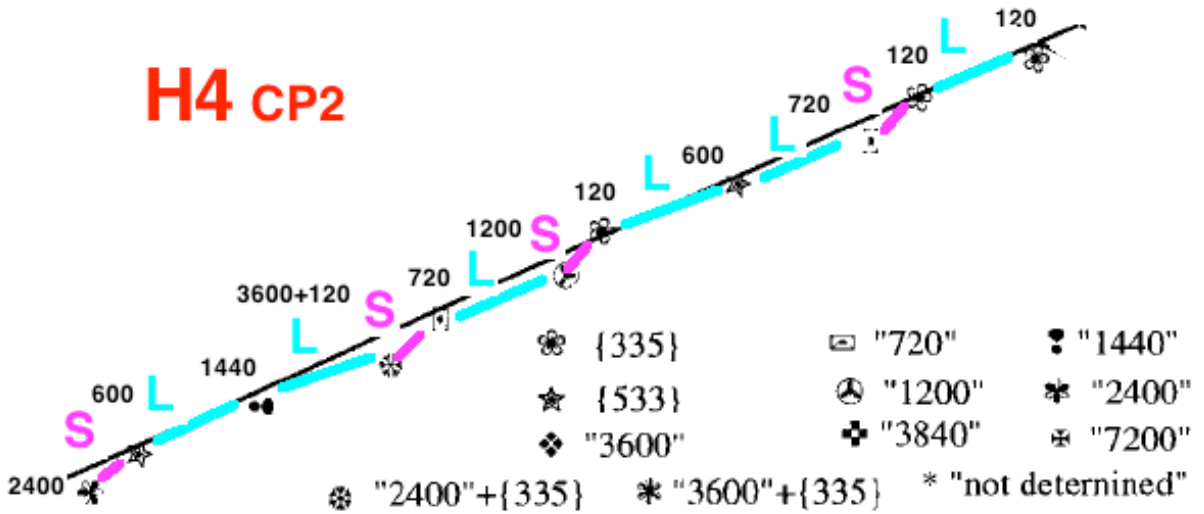

Sixth,
look at the combined Shell Structures of H4 M4 and H4 CP2:

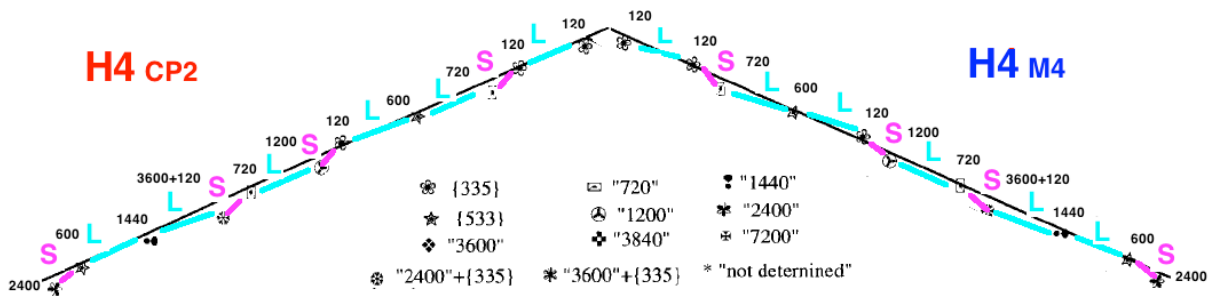

At this stage, you see the M4 and CP2 parts of the Schwinger Source Cloud
but
you have not yet seen the full E8 Schwinger Source Cloud.
For that, you need to go to the 7th Step:

Seventh,
combine the H4 M4 and H4 CP2 parts to form the full E8 Schwinger Source:

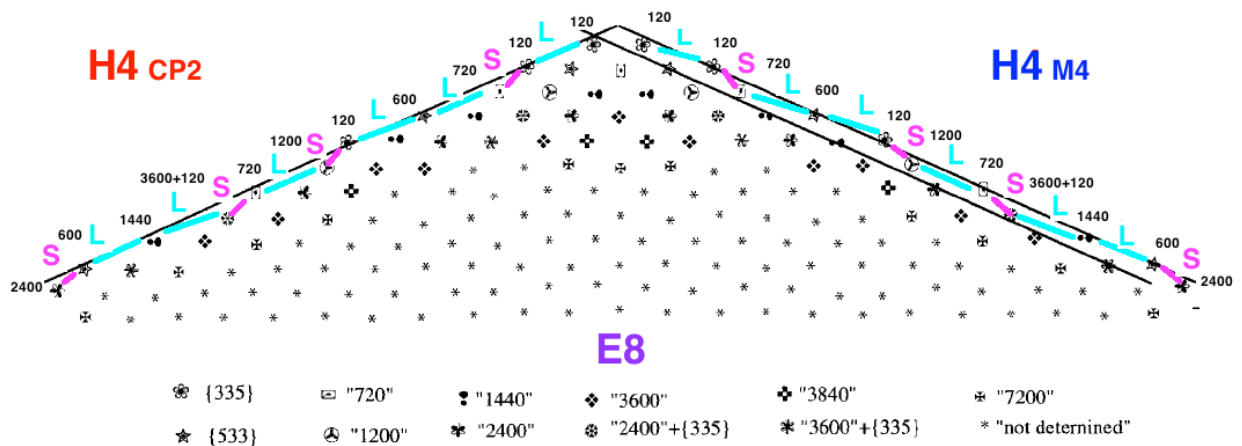

How does the Schwinger Source look on larger scales ?

In the 4D M4 Minkowski Physical Spacetime part of M4 x CP2 Kaluza-Klein it looks like a Gravitational Black Hole.

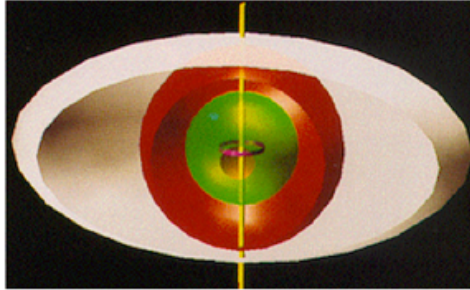

Ergosphere (white), Outer Event Horizon (red), Inner Event Horizon (green), and Ring Singularity (purple) from *Black Holes - A Traveller's Guide*, by Clifford Pickover (Wiley 1996).

**David Finkelstein invented the one-way membrane of the Black Hole.
David's Black Hole can be generalized to deal with Spin
and the. (-1 +1) Charge of the U(2) ElectroWeak Force**

The generalization is called a Kerr-Newman Black Hole,

The Zeldovich-Hawking Process,
in which a Virtual Particle-AntiParticle Pair near the Event Horizon can be separated
with one of the Virtual Pair going into the Black Hole
and
the other going into External Spacetime,

can be applied to Quark-AntiQuark Virtual Pairs showing that

a Black Hole can carry Color Charge of the SU(3) Color Force.

Quantum Kernel Functions and Schwinger Source Green's Functions

Fock "Fundamental of Quantum Mechanics" (1931) showed that it requires Linear Operators "... represented by a definite integral [of a]... kernel ... function ...".

Hua "Harmonic Analysis of Functions of Several Complex Variables in the Classical Domains" (1958) showed Kernel Functions for Complex Classical Domains.

Schwinger (1951 - see Schweber, PNAS 102, 7783-7788) "... introduced a description in terms of Green's functions, what Feynman had called propagators ... The Green's functions are vacuum expectation values of time-ordered Heisenberg operators, and the field theory can be defined non-perturbatively in terms of these functions ...[which]... gave deep structural insights into QFTs; in particular ... the structure of the Green's functions when their variables are analytically continued to complex values ...".

Wolf (J. Math. Mech 14 (1965) 1033-1047) showed that the Classical Domains (complete simply connected Riemannian symmetric spaces) representing 4-dim Spacetime with Quaternionic Structure are:

$S^1 \times S^1 \times S^1 \times S^1 = 4$ copies of $U(1)$

$S^2 \times S^2 = 2$ copies of $SU(2)$

$CP^2 = SU(3) / SU(2) \times U(1)$

$S^4 = Spin(5) / Spin(4) =$ Euclidean version of $Spin(2,3) / Spin(1,3)$

Armand Wyler (1971 - C. R. Acad. Sc. Paris, t. 271, 186-188) showed how to use **Green's Functions = Kernel Functions** of Classical Domain structures characterizing **Sources = Leptons, Quarks, and Gauge Bosons,** to calculate **Particle Masses and Force Strengths**

Schwinger (1969 - see physics/0610054) said: "... operator field theory ... replace[s] the particle with ... properties ... distributed throughout ... small volumes of three-dimensional space ... particles ... must be created ... even though we vary a number of experimental parameters ... The properties of the particle ... remain the same ... We introduce a quantitative description of the particle source in terms of a source function ...

we do not have to claim that we can make the source arbitrarily small ... the experimenter... must detect the particles ...[by]... collision that annihilates the particle ... the source ... can be ... an abstraction of an annihilation collision, with the source acting negatively, as a sink ... The basic things are ... the source functions ... describing the intermediate propagation of the particle ...".

Creation and Annihilation operators indicate a Clifford Algebra, and 8-Periodicity shows that the basic Clifford Algebra is formed by tensor products of 256-dim $Cl(8)$ such as $Cl(8) \times Cl(8) = Cl(16)$ containing 248-dim $E_8 = 120$ -dim $D_8 + 128$ -dim D_8 half-spinor whose maximal contraction is a realistic generalized Heisenberg Algebra

$$\hbar^2 \times A_7 = 5\text{-graded } 28 + 64 + ((SL(8,R)+1) + 64 + 28$$

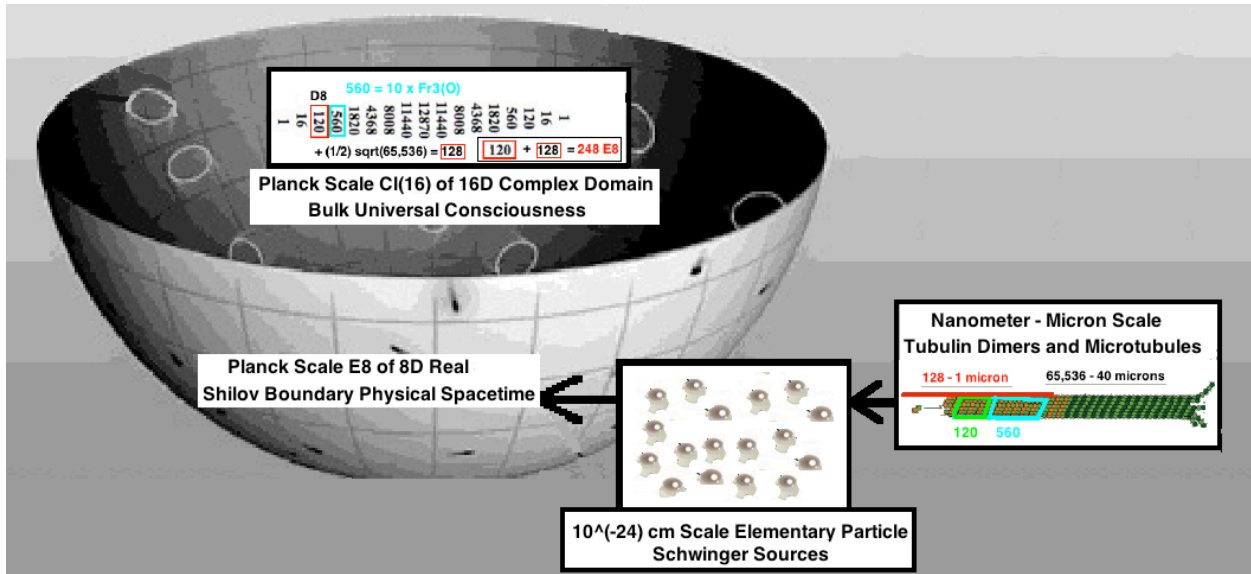

In E8-Cl(16) Physics **Spacetime is the 8-dimensional Shilov Boundary RP1 x S7** of the **Type IV8 Bounded Complex Domain Bulk Space** of the Symmetric Space Spin(10) / Spin(8)xU(1) which **Bulk Space** has 16 Real dimensions and is the Vector Space of the Real Clifford Algebra Cl(16).

By 8-Periodicity,

Cl(16) = tensor product Cl(8) x Cl(8) = Real 256x256 Matrix Algebra M(R,256) and so has 256x256 = 65,536 elements.

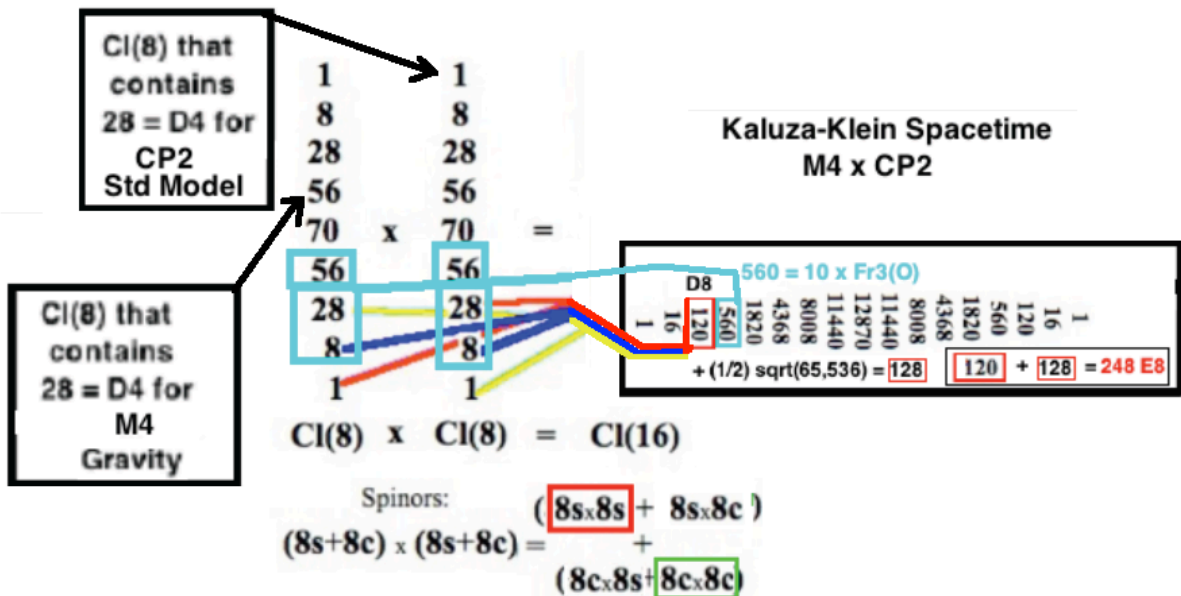

Cl(8) has 8 Vectors, 28 BiVectors, and 16 Spinors with 8+28+16 = 52 = F4 Lie Algebra and has 56 TriVectors for the Fr3(O) Freudenthal Algebra of World-Line String Theory.

Cl(16) has 120 BiVectors, and 128 Half-Spinors with 120+128 = 248 = E8 Lie Algebra, and has 560 TriVectors for 10 copies of Fr3(O).

The 248 E8 elements of Cl(16) define a Lagrangian for the Standard Model and for Gravity - Dark Energy and the 560 Fr3(O) elements define a 26D World-Line=String Theory with Tachyons to populate Schwinger Sources and traceless symmetric 24x24 Bohm Quantum Potential There are also 16-dim Cl(16) Vectors.

Therefore:

65,536 - 248 - 560 - 16 = 64,712 elements of Cl(16) can carry Bits of Information.

The Complex Bulk Space Cl(16) contains the Maximal Contraction of E8 which is

H92 + A7

a generalized Heisenberg Algebra of Quantum Creation-Annihilation Operators with graded structure

28 + 64 + ((SL(8,R)+1) + 64 + 28

We live in the Physical Minkowski M4 part of Kaluza-Klein M4 x CP2 (where CP2 = SU(3) / SU(2)xU(1) is Internal Symmetry Space of Standard Model gauge groups)

The Physical Boundary in which we live is a Real Shilov Boundary in which E8 is manifested as Lagrangian Structure of Real Forms of E8 with Lagrangian Symmetric Space structure:

E8 / D8 = (OxO)P2 for 8 First-Generation Fermion Particles and 8 First-Generation Fermion AntiParticles (8 components of each)

D8 / D4 x D4 for 8-dim spacetime paths, one for each of 8 Fermion Types D4 for Standard Model Gauge Bosons and Gravity - Dark Energy Ghosts D4 for Gravity - Dark Energy Gauge Bosons, Propagator Phase, and Standard Model Ghosts

The Bulk Space Complex Domain Type IV8 corresponds to the Symmetric Space Spin(10) / Spin(8)xU(1)

and is a Lie Ball whose Shilov Boundary RP1 x S7 is a Lie Sphere 8-dim Spacetime. It is related to the Stiefel Manifold V(10,2) = Spin(10) / Spin(8) of dimension 20-3 = 17 by the fibration

$$\text{Spin}(10) / \text{Spin}(8) \times U(1) \rightarrow V(10,2) \rightarrow U(1)$$

It can also be seen as a tube $z = x + iy$ whose imaginary part is physically inverse momentum so that its points give both position and momentum

(see R. **Coquereaux** Nuc. Phys. B. 18B (1990) 48-52 "Lie Balls and Relativistic Quantum Fields").

In "Harmonic Analysis of Functions of Several Complex Variables in the Classical Domains" L. K. **Hua** said: "... Editor's Foreword ... M. I. Graev ...

Poisson kernel can be defined in group-theoretic terms. Let \mathfrak{R} be one of the domains considered in the book, and \mathfrak{C} its characteristic manifold. Let z be a point in \mathfrak{R} and C_z the group of those analytic automorphisms of \mathfrak{R} which leave z invariant. It can be shown that the group C_z is transitive on \mathfrak{C} , i.e., transforms any point of \mathfrak{C} into any other point. The measure on \mathfrak{C} which is invariant under the transformations in C_z is then simply equal to the Poisson kernel.

...[Characteristic Manifold = Shilov Boundary]...

In 1935, E. Cartan [1] proved that there exist only six types of irreducible homogeneous bounded symmetric domains. Beside the four types, RI, RII, RIII, RIV there exist only two; their dimensions are 16 and 27.

[16-Complex-Dimensional $E_6 / \text{Spin}(10) \times U(1) = (C \times O)P^2$
 27-Complex-Dimensional $E_7 / E_6 \times U(1) = J(3, (C \times O))$]

The domain \mathfrak{R}_{IV} of n -dimensional ($n > 2$) vectors

$$z = (z_1, z_2, \dots, z_n)$$

(z_k are complex numbers) satisfying the conditions

$$|zz'|^2 + 1 - 2zz' > 0, \quad |zz'| < 1.$$

The complex dimension of the four domains is $mn, n(n+1)/2, n(n-1)/2, n$.

The author has shown (cf. L. K. Hua [3]) that \mathfrak{R}_{IV} can also be regarded as a homogeneous space of $2 \times n$ real matrices. Therefore, the study of all these domains can be reduced to a study of the geometry of matrices.

...”

In Annals of Mathematics 55 (1952) 19-33 P. R. **Garabedian** said “...

we turn here to a more direct development of the theory of boundary value problems associated with the Cauchy-Riemann equations for analytic functions of several complex variables.

This boundary value problem is solved by means of a Dirichlet principle, and we introduce a Green's function in terms of which the solution can be expressed as a boundary integral. A formula giving the Bergman kernel function for several variables [1] in terms of this Green's function is obtained, and we thus generalize known theorems from the theory of functions of one complex variable

for analytic functions of several complex variables.

Bergman [1] defines a kernel function $k(z, t)$, analytic in z and \bar{t} for $z, t \in D$

THEOREM 3. *The analytic kernel function $k(z, t)$ with*

$$g(t) = \int_D g(z) \overline{k(z, t)} d\tau$$

for each analytic function g in D has the representation

$$k(z, t) = \Delta_z \theta(z, t) \quad \text{in terms of the Green's function } \theta(z, t).$$

...”

E8 Physics constructs the **Lagrangian** integral such that the **mass m emerges as the integral over the Schwinger Source spacetime region** of its Kerr-Newman cloud of virtual particle/antiparticle pairs plus the Valence Fermion so that the volume of the Schwinger Source fermion defines its mass, which, being dressed with the particle/antiparticle pair cloud, gives **quark mass as constituent mass**.

Armand Wyler used Harmonic Geometry to calculate:

Fermion masses as a product of four factors:

$$V(Q\text{fermion}) \times N(\text{Graviton}) \times N(\text{octonion}) \times \text{Sym}$$

$V(Q\text{fermion})$ is the volume of the part of the half-spinor fermion particle manifold $S^7 \times RP^1$ related to the fermion particle by photon, weak boson, or gluon interactions.

$N(\text{Graviton})$ is the number of types of $\text{Spin}(0,5)$ graviton related to the fermion.

$N(\text{octonion})$ is an octonion number factor relating up-type quark masses to down-type quark masses in each generation.

Sym is an internal symmetry factor, relating 2nd and 3rd generation massive leptons to first generation fermions. It is not used in first-generation calculations.

Force Strengths are made up of two parts:

- the relevant spacetime manifold of gauge group global action
- the $U(1)$ photon sees 4-dim spacetime as $T^4 = S^1 \times S^1 \times S^1 \times S^1$
- the $SU(2)$ weak boson sees 4-dim spacetime as $S^2 \times S^2$
- the $SU(3)$ weak boson sees 4-dim spacetime as CP^2
- the $\text{Spin}(5)$ of gravity sees 4-dim spacetime as S^4
- and

the volume of the Shilov boundary corresponding to the symmetric space with local symmetry of the gauge boson. The nontrivial Shilov boundaries are:

- for $SU(2)$ Shilov = $RP^1 \times S^2$
- for $SU(3)$ Shilov = S^5
- for $\text{Spin}(5)$ Shilov = $RP^1 \times S^4$

Schwinger Sources as described above are continuous manifold structures of Bounded Complex Domains and their Shilov Boundaries but the E8-CI(16) model at the Planck Scale has spacetime condensing out of Clifford structures forming a Lorentz Leech lattice underlying 26-dim String Theory of World-Lines with $8 + 8 + 8 = 24$ -dim of fermion particles and antiparticles and of spacetime.

The automorphism group of a single 26-dim String Theory cell modulo the Leech lattice is the Monster Group of order about 8×10^{53} .

Schwinger Sources and Indra's Net

The automorphism group of a single 26-dim String Theory cell modulo the Leech lattice is the Monster Group of order about 8×10^{53} .

The Monster Group is of order
 $8080, 17424, 79451, 28758, 86459, 90496, 17107, 57005, 75436, 80000, 00000$
 $=$
 $2^{46} \cdot 3^{20} \cdot 5^9 \cdot 7^6 \cdot 11^2 \cdot 13^3 \cdot 17 \cdot 19 \cdot 23 \cdot 29 \cdot 31 \cdot 41 \cdot 47 \cdot 59 \cdot 71$
 or about 8×10^{53}

This chart (from Wikipedia) shows the Monster M and other Sporadic Finite Groups

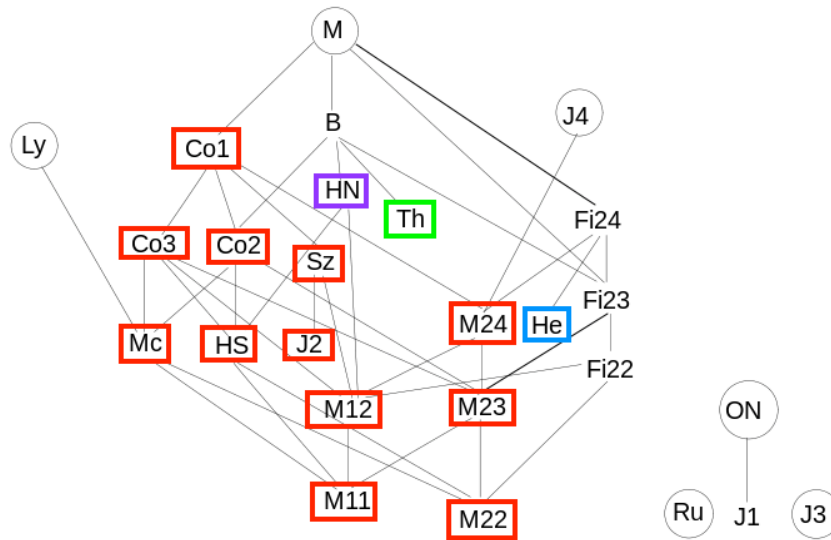

The order of Co1 is $2^{21} \cdot 3^9 \cdot 5^4 \cdot 7^2 \cdot 11 \cdot 13 \cdot 23$ or about 4×10^{18} .

Aut(Leech Lattice) = double cover of Co1.

The order of the double cover $2 \cdot \text{Co1}$ is $2^{22} \cdot 3^9 \cdot 5^4 \cdot 7^2 \cdot 11 \cdot 13 \cdot 23$ or about 0.8×10^{19} .

Taking into account the non-sporadic part of the Leech Lattice symmetry

according to the ATLAS at brauer.maths.qmul.ac.uk/Atlas/v3/spor/M/

the Schwinger Source Kerr-Newman Cloud Symmetry $s 2^{(1+24)} \cdot \text{Co1}$

of order $139511839126336328171520000 = 1.4 \times 10^{26}$

Co1 and its subgroups account for 12 of the 19 subgroups of the Monster M.

Of the remaining 7 subgroups, Th and He are independent of the Co1 related

subgroups and HN has substantial independent structure.

Th = Thompson Group. Wikipedia says "... Th ... was ... constructed ... as the automorphism group of a certain lattice in the 248-dimensional Lie algebra of E8.

It does not preserve the Lie bracket of this lattice, but

does preserve the Lie bracket mod 3, so is a subgroup of the Chevalley group E8(3).

The subgroup preserving the Lie bracket (over the integers) is a maximal

subgroup of the Thompson group called the Dempwolff group (which unlike the

Thompson group is a subgroup of the compact Lie group E8) ...

the Thompson group acts on a vertex operator algebra over the field with 3 elements.

This vertex operator algebra contains the E8 Lie algebra over \mathbf{F}_3 ,

giving the embedding of Th into E8(3) ...

The Schur multiplier and the outer automorphism group of ... Th ... are both trivial.

Th is a sporadic simple group of order $215 \cdot 310 \cdot 53 \cdot 72 \cdot 13 \cdot 19 \cdot 31$

$= 90745943887872000 \approx 9 \times 10^{16}$...".

He = Held Group. Wikipedia says "... The smallest faithful complex representation has dimension 51; there are two such representations that are duals of each other.

It centralizes an element of order 7 in the Monster group. ...

the prime 7 plays a special role in the theory of the group ...

the smallest representation of the Held group over any field is

the 50 dimensional representation over the field with 7 elements ...

He ... acts naturally on a vertex operator algebra over the field with 7 elements ...

The outer automorphism group has order 2 and the Schur multiplier is trivial. ...

He is a sporadic simple group of order $210 \cdot 33 \cdot 52 \cdot 73 \cdot 17$

$= 4030387200 \approx 4 \times 10^9$...".

HN = Harada-Norton Group. Wikipedia says "... The prime 5 plays a special role ...

it centralizes an element of order 5 in ... the Monster group ...and as a result acts

naturally on a vertex operator algebra over the field with 5 elements ... it acts on

a 133 dimensional algebra over \mathbf{F}_5 with a commutative but nonassociative product ...

Its Schur multiplier is trivial and its outer automorphism group has order 2 ...

HN is a sporadic simple group of order $2^{14} \cdot 3^6 \cdot 5^6 \cdot 7 \cdot 11 \cdot 19$

$= 273030912000000 \approx 3 \times 10^{14}$...

HN has an involution whose centralizer is of the form $2.HS.2$, where HS is the Higman-Sims group ... of order $2^9 \cdot 3^2 \cdot 5^3 \cdot 7 \cdot 11 = 44352000 \approx 4 \times 10^7$... [whose] Schur multiplier has order 2 ... [and whose] outer automorphism group has order 2 ... HS is ... a subgroup of ... the Conway groups Co0, Co2 and Co3 ...".

Co1 x Th x He x HN / HS together have order about $4 \times 9 \times 4 \times 10^{(18+16+9+7)}$
 = about 10^{52} which is close to the order of M = about 10^{54} .

The components of the Monster Group describe the composition of Schwinger Sources:

Co1 gives the number of particles in the Schwinger Source Kerr-Newman Cloud emanating from a Valence particle in a Planck-scale cell of E8 Physics SpaceTime.

Th gives the 3-fold E8 Triality structure relating 8-dim SpaceTime to First-Generation Fermion Particles and AntiParticles.

He gives the 7-fold algebraically independent Octonion Imaginary E8 Integral Domains that make up 7 of the 8 components of Octonion Superposition E8 SpaceTime.

HN / HS gives the 5-fold symmetry of 120-element Binary Icosahedral E8 McKay Group beyond the 24-element Binary Tetrahedral E6 McKay Group at which level the Shilov Boundaries of Bounded Complex Domains emerge to describe SpaceTime and Force Strengths and Particle Masses.

When a fermion particle/antiparticle appears in E8 spacetime it does not remain a single Planck-scale entity because **Tachyons create a cloud of particles/antiparticles**. The cloud is one Planck-scale Fundamental Fermion Valence Particle plus an effectively neutral cloud of particle/antiparticle pairs forming a Kerr-Newman black hole. That cloud constitutes the **Schwinger Source**. Its **structure comes from the 24-dim Leech lattice part of the Monster Group which is**

$2^{(1+24)}$ times the double cover of Co1, for a total order of about 10^{26} .

Since a Leech lattice is based on copies of an E8 lattice and since there are 7 distinct E8 integral domain lattices there are 7 (or 8 if you include a non-integral domain E8 lattice) distinct Leech lattices. The physical Leech lattice is a superposition of them, effectively adding a factor of 8 to the order.

The volume of the Kerr-Newman Cloud is on the order of 10^{27} x Planck scale, so the Kerr-Newman Cloud **Source should contain about 10^{27} particle/antiparticle pairs and its size should be about $10^{(27/3)} \times 1.6 \times 10^{(-33)}$ cm = roughly $10^{(-24)}$ cm.**

Schwinger Sources as Jewels of Indra's Net

Each Schwinger Source particle-antiparticle pair should see
with Bohm Quantum Potential
the rest of our Universe in the perspective of 8×10^{53} Monster Symmetry

so

a Schwinger Source acting as a Jewel of Indra's Net
of Schwinger Source Bohm Quantum Blockchain Physics (viXra 1801.0086)
can see / reflect Other Schwinger Sources
all of which act as Jewels of Indra's Net.

Each Schwinger Source has 10^{27} particle-antiparticle pairs
each of which has can be given an ordered position within the Schwinger Source
and

each particle-antiparticle pair can see through the lens of Monster Symmetry
 8×10^{53} distinct "Other Schwinger Sources"

so

the given Schwinger Source can see $10^{27} \times 8 \times 10^{53} = 8 \times 10^{80}$ Other Sources

The given Schwinger Source orders the Other Sources in two different ways:
by position of each of the 10^{27} particle-antiparticle pairs
within the given Schwinger source
and

by Symmetry-Order of the Monster Group (8×10^{53})
for each "seen Other" by each particle-antiparticle pair.

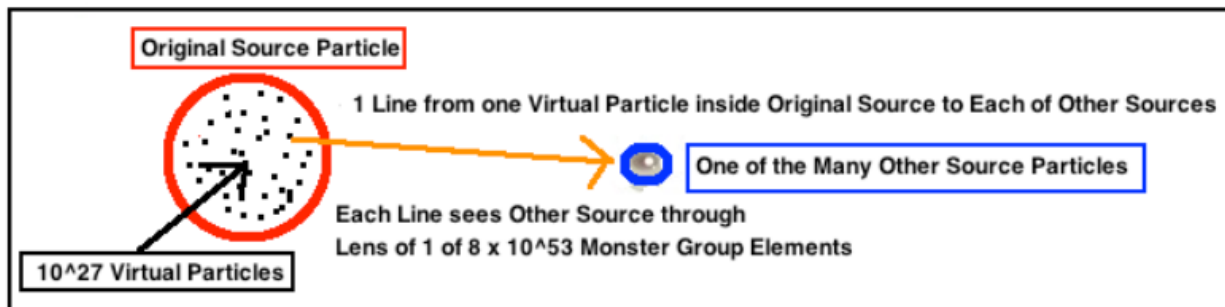

The fact that there are two different orderings (position and Monster Symmetry) is a problem because sharing information throughout Indra's Net requires a simple consistent ordering of information of up to 8×10^{80} qubits of information held within each Schwinger Source Jewel of Indra's Net.

Such a simple consistent ordering of information can be done by Fractals. Julia Sets can correspond to the Other Sources, distinguishing between them, and the Mandelbrot Set can order the Julia Sets:

Peitgen, Jurgens, and Saupe in Chaos and Fractals (1992) say "... Riemann Mapping Theorem ... [gives] A one-to-one correspondence between the potential of the unit disk and the potential of any connected prisoner set ... corresponding to $z \rightarrow z^2 + c$...

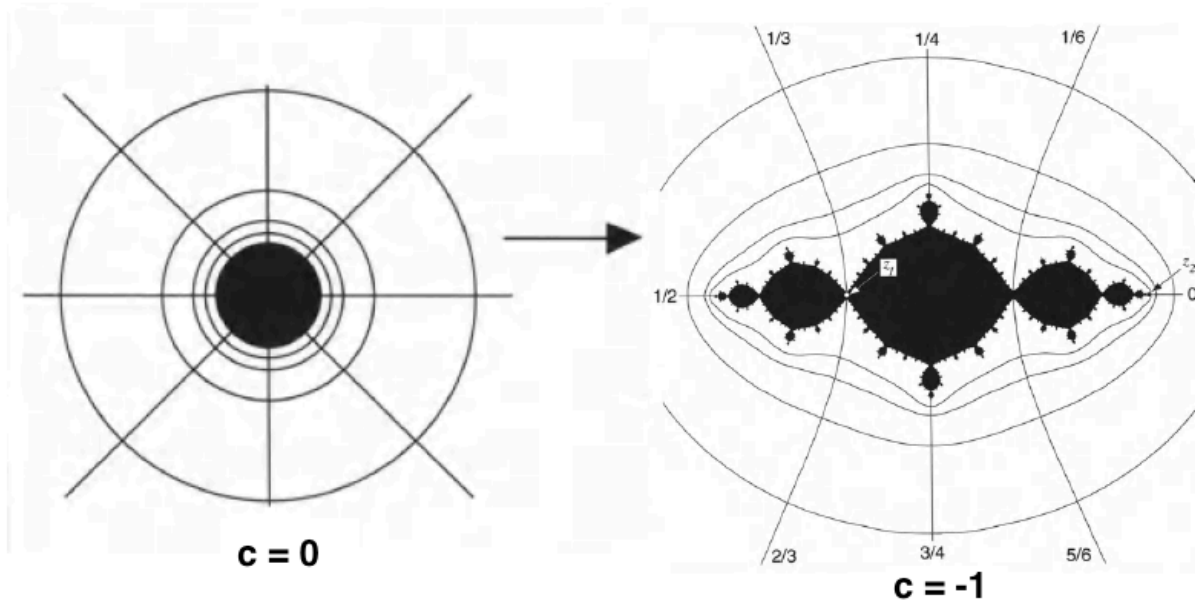

... using $c = -1$... There are two fixed points,
 $z_1 = (1 - \sqrt{5}) / 2$ and $z_2 = (1 + \sqrt{5}) / 2$
 ... The derivatives ... at z_1 and z_2 are $|1 \pm \sqrt{5}| > 1$.
 Thus, both fixed points are repelling and consequently points of the Julia set ...
 therefore ... each will identify a field line ...
 The potential function ...
 induce[s] a natural decomposition of the escape set ... into level sets ...
 a binary decomposition of ... level sets ... provide[s] a means of identifying field lines and dynamics ...

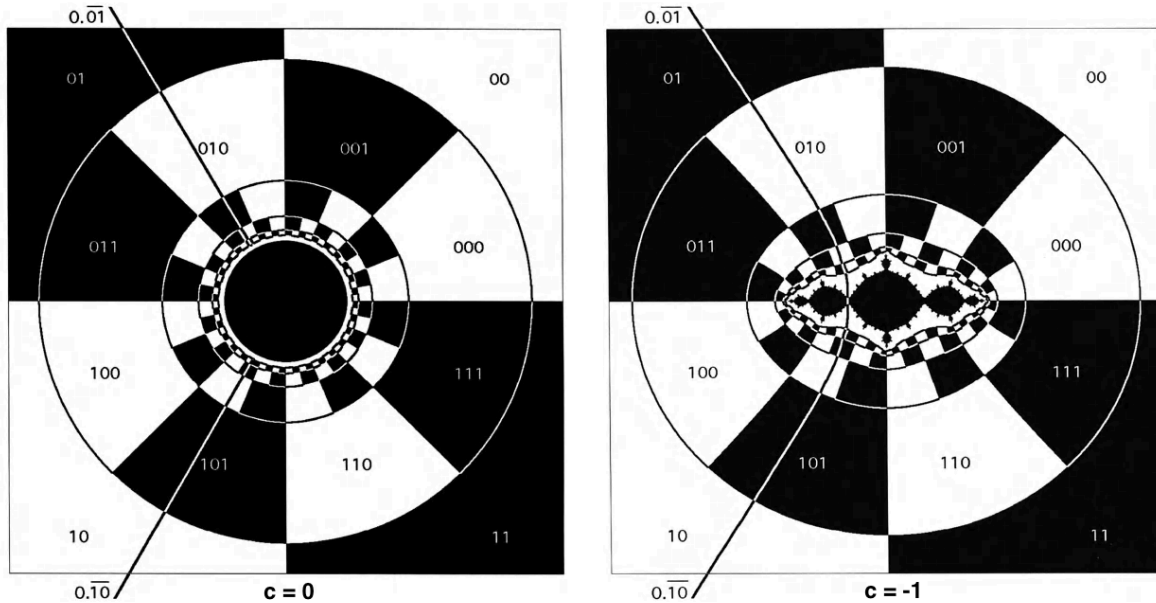

... There are 2^{2n} stage-n cells in a level set ...”.

A stage-256 Julia level set based on Binary Decompositionn has $2^{256} = \text{about } 10^{77}$ cells so Full Indra Net information can be seen / reflected by each Schwinger Source Indra Jewel.

Julia Sets of Schwinger Sources and Green’s Functions

The Schwinger Source Particles that we deal with experimentally are Kerr-Newman Cloud Shilov Boundaries of Bounded Complex Domains that have symmetry from the 24-dim Leech lattice part of the Monster Group and have volume about 10^{27} Planck Volumes and size about $10^{-(24)}$ cm.

The Bounded Complex Domain structure of each Schwinger Source gives it (through Bergman Kernel) a Green’s Function for its force interactions. The Green’s Function is manifested in the interior of the Schwinger Source Cloud by Julia Set organization of the component small particles in the Cloud.

Each cell of the Planck-scale local lattice has a Mandelbrot structure that contains potential Julia Sets. When a Valence Particle manifests itself at a cell of the Planck-scale local lattice it uses a Julia set with matching Green’s Function.

M. F. Barnsley, J. S. Geronimo, and A. N. Harrington say in Geometrical and Electrical Properties of Some Julia Sets (Georgia Tech August 1982) “... electrical properties of Julia sets of an arbitrary potential ... are developed with the aid of the Bottcher equation and Green’s star domains ... We use Julia sets for $T(z) = (z - L)^2$ as examples and relate the electrical properties to the geometry of the Julia set ...”.

Peitgen, Jurgens, and Saupe in Chaos and Fractals (1992) say

“... points for which the iteration escapes ... is called the escape set ... The iteration for all other initial values remains in a bounded region forever ... the ... prisoner set ... the boundary ... between the basins of attraction ... is ... the Julia set ... Encirclement of the Prisoner Set ... [by] iteration ... [of] approximation ... shad[ing] the encirclements ... using alternating black and white sets ... for $c = -2$... $c = -1$... $c = i$...

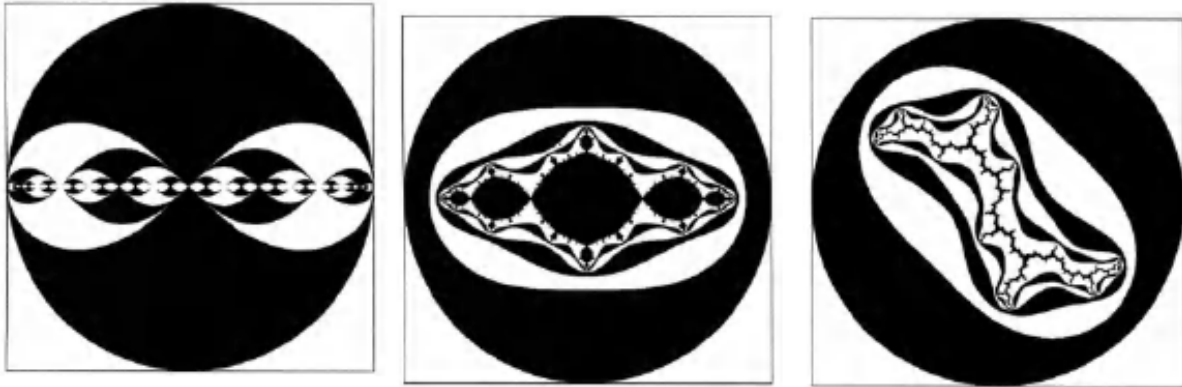

... Think of the prisoner set as a piece of metal charged with electrons ... produc[ing] an electrostatic field in the surrounding space ... [which has] field lines ... an electrostatic field ... is conservative ... there is ... a potential function ... equipotential surfaces ... on which the potential is constant ... are perpendicular everywhere to the direction of the electrostatic field ... the intensity of the field is inversely proportional to the distance between equipotential surfaces ... Riemann Mapping Theorem ... [gives] A one-to-one correspondence between the potential of the unit disk and the potential of any connected prisoner set ...

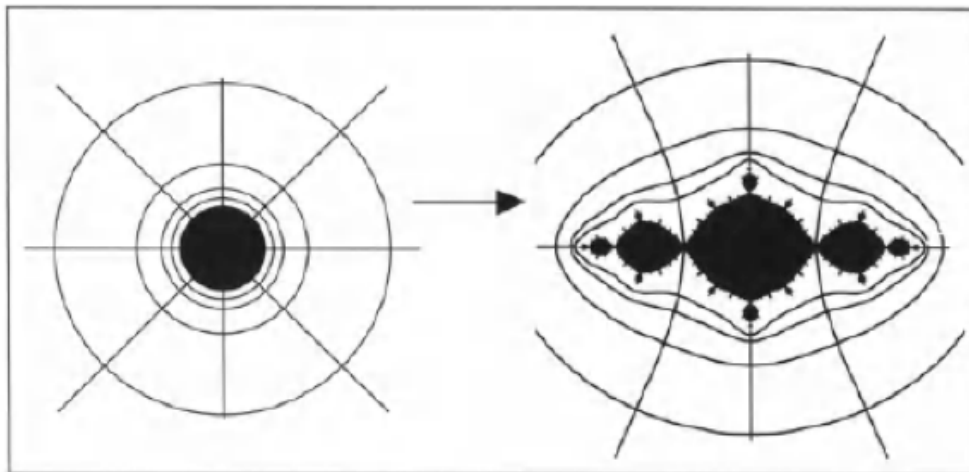

... Equipotential and field lines for $c = -1$.
The angles of the field lines are given in multiples of 2π ...

Binary decomposition for $c = -1$... [and] $c = i$...

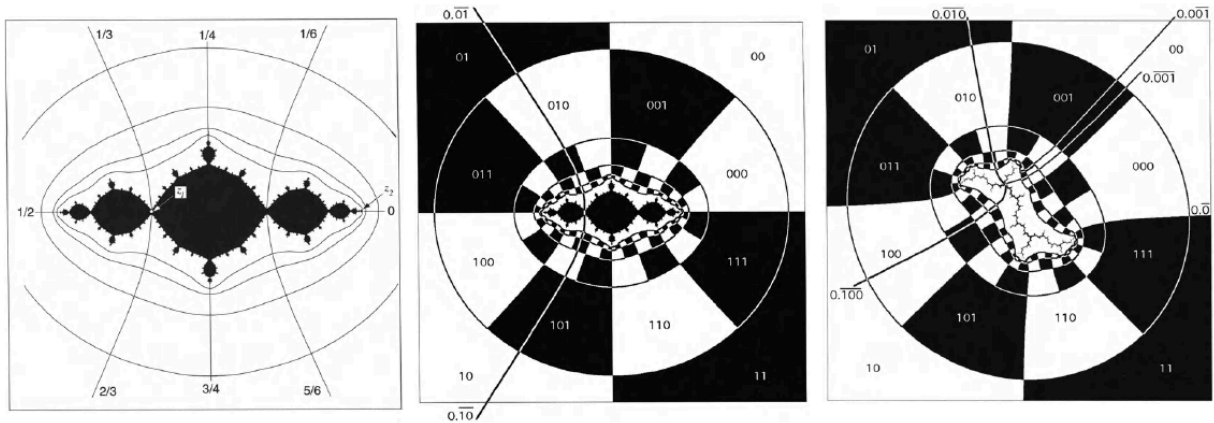

... potential ... level sets capture ... the magnitude of the iterates ...

Now ... turn to the binary decomposition of these level sets ...

There are 2^n stage- n cells in a level set ...

Binary decomposition allows us to approximate arbitrary field lines of the potential. the labelling of these cells converges to the binary expansion of the angles of the field lines passing through the cells ... Only in the limit ... do field lines become ... straight ... from the point of view of field line dynamics ... the dynamics of $z \rightarrow z^2 + c$, $c \neq 0$, acts like angle doubling, just as for $c = 0$...”.

Each point on the Mandelbrot Set Determines a Julia Set:

Peitgen, and Richter in *The Beauty of Fractals* (1986) say

“... Mandelbrot's ingenuity was to look at complex numbers ... to follow the process ... on a plane ... Mandelbrot's process is ... $x \rightarrow x^2 + c$...”.

Here, near their locations on the Mandelbrot Set, are some Julia Sets useful in describing Schwinger Source Geometry: $c = -2$, $c = -1$, $c = i$, $c = 0$, $c = -i$:

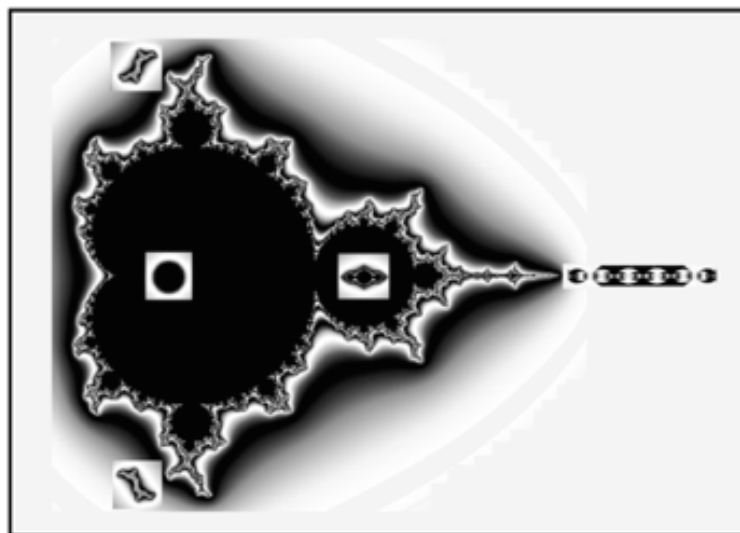

(image from *Mandelbrot and Julia* by Dany Shaanan and by Peitgen, Jurgens, and Saupe)

How many Schwinger Sources are in the Indra's Net of Our Universe ?

Based on gr-qc/0007006 by Paola Zizzi, the Inflation Era of Our Universe ended with Quantum Decoherence when its number of qubits reached 2^{64} for $Cl(64) = Cl(8)^8$ self-reflexivity whereby each $Cl(8)$ 8-Periodicity component corresponded to each basis element of the $Cl(8)$ Vector Space.

At the End of Inflation, each of the 2^{64} qubits transforms into 2^{64} elementary first-generation fermion particle-antiparticle pairs. The resulting $2^{64} \times 2^{64}$ pairs constitute a Zizzi Quantum Register of order $2^{64} \times 2^{64} = 2^{128}$.

At Reheating time $T_n = (n+1) T_{Planck}$ the Register has $(n+1)^2$ qubits so at Reheating Our Universe has $(2^{128})^2 = 2^{256} = 10^{77}$ qubits and since each qubit corresponds to fermion particle-antiparticle pairs that average about 0.66 GeV so

the number of particles in our Universe at Reheating is about 10^{77} nucleons which, being less than 10^{80} , can be reflected by Schwinger Source Indra Jewels.

The Reheating process raises the energy/temperature at Reheating to $E_{reh} = 10^{14}$ GeV, the geometric mean of the $E_{Planck} = 10^{19}$ GeV and $E_{decoh} = 10^{10}$ GeV.

After Reheating, our Universe enters the Radiation-Dominated Era, and, since there is no continuous creation, particle production stops, so the **10^{77} nucleon Baryonic Mass of our Universe has been mostly constant since Reheating**

Since 10^{77} is smaller than 8×10^{80} Schwinger Sources can be realistic Indra's Jewels of Indra's Net.

Indra's Net BlockChain

"... "Indra's net" is the net of the Vedic deva Indra, whose net hangs over his palace on Mount Meru, the axis mundi of Buddhist and Hindu cosmology. In this metaphor, Indra's net has a multifaceted jewel at each vertex, and each jewel is reflected in all of the other jewels ... the image of "Indra's net" is used to describe the interconnectedness of the universe ... Francis H Cook describes Indra's net thus:
"Far away in the heavenly abode of the great god Indra, there is a wonderful net ... a single glittering jewel in each "eye" of the net ... in ... each of the jewels ... its polished surface ... reflect[s] all the other jewels in the net ... Not only that, but each of the jewels reflected in this one jewel is also reflecting all the other jewels ..." "

Image from <https://brightwayzen.org/meetings-placeholder/indras-net-honoring-interdependence-scales/> :

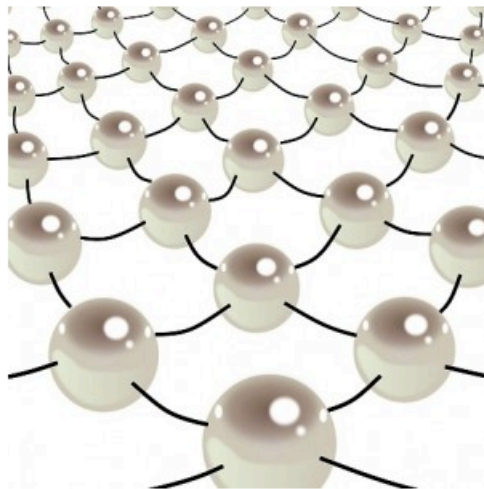

In E8-Cl(16) Physics each Indra Jewel is a Schwinger Source.

26D Freudenthal Fr3(O) String Theory - Bohm Quantum Potential

Schwinger Sources come from Tachyons of 26D String Theory:
where **Strings are World-Lines** of Particles and
spin-2 String Theory 24x24 symmetric matrices
are carriers of Bohm Quantum Potential (not gravitons).

Blockchain Structure of Bohm Quantum Potential

Andrew Gray in arXiv quant-ph/9712037 said:

“... **probabilites are ... assigned to entire fine-grained histories ... base[d] ... on the Feynman path integral formulation ...**
... [It] **is fully relativistic and applicable to multi-particle systems ...[and]...**
makes the same experimental predictions as quantum field theory ...
consider space and time cut up into small volume elements
... and then take the limit as ... volume ... $\rightarrow 0$...
get the final amplitude ... by considering all possible distributions at a time t earlier ...
for each such distribution the amplitude for it to occur [is] multiplied by the amplitude to get ... the final distribution ... **the interference factor ... is a measure of how much interference between the different possible histories that contain the distribution of interest there is at each time** ... This result is the ...
Feynman amplitude squared times the product of all the interference factors ...”.

Luis E. Ibanez and Angel M. Uranga in “String Theory and Particle Physics” said:
“... String theory proposes ... small one-dimensional extended objects, strings,
of typical size $L_s = 1/M_s$, with M_s known as the string scale ...
As a string evolves in time, it sweeps out a two-dimensional surface in spacetime,
known as the worldsheet, which is the analog of the ... worldline of a point particle ...
for the bosonic string theory ... the classical string action is the total area spanned by
the worldsheet ... This is the ... Nambu– Goto action ...”.

Therefore

in Cl(16) Physics the Indra’s Net of Schwinger Source Jewels
would not have Bohm Quantum Potential interactions between two Jewels,
rather **the interactions would be between the two entire World-Line History Strings**



(image adapted from <http://www.blockchaintechnologies.com/>)

The Gray Fine-Grained History Quantum Theory
is equivalent to
the Nambu-Goto action of 26D String Theory.
Nambu-Goto 24x24 traceless spin-2 particle
is
Quantum Bohmion carrier of Bohm Quantum Potential

Roderick I. Sutherland (arXiv 1509.02442v3) has given a Lagrangian for the Gray Fine-Grained Nambu-Goto Quantum Bohm Potential that has been extended by Jack Sarfatti to include nonlinear Back-Reaction

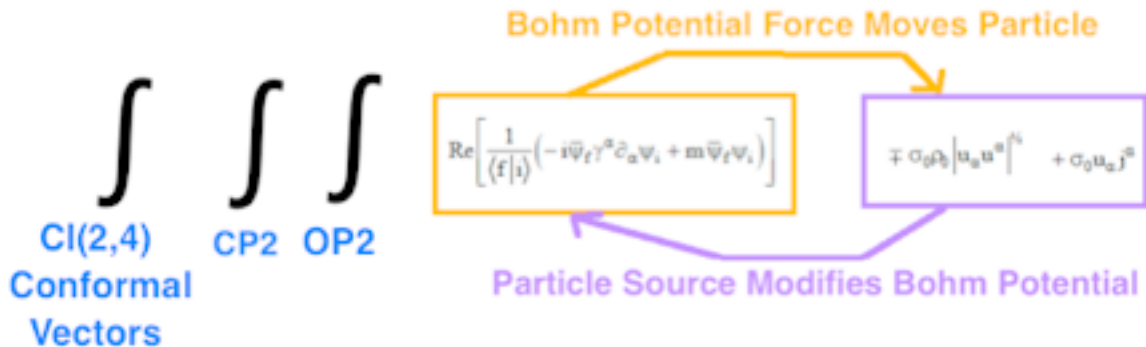

that enables Penrose-Hameroff Quantum Consciousness and Free Will, justifying **Clifford’s characterization of Real Clifford Algebras as** “... mind-stuff tak[ing] the form of ... human consciousness ...”.

Each **Blockshain Node is a Schwinger Source** connected by Bohm Quantum Potential to all other Schwinger Source Nodes in our Universe and governed by the “algorithms and rules” of the CI(16) Physics Lagrangian and the Algebraic Quantum Field Theory arising from the completion of the union of all tensor products of copies of CI(16) each copy of CI(16) containing E8 and the E8 Lagrangian. According to <http://www.blockchaintechnologies.com/> “... **A blockchain is a type of distributed ledger**, comprised of unchangable, digitally recorded data in packages called blocks. These digitally recorded "blocks" of data is stored in a linear chain ...



... A distributed ledger is a consensus of replicated, shared, and synchronized digital data geographically spread across multiple sites, countries, and/or institutions ...”

or,
in the case of the CI(16) Physics Indra’s Net of Schwinger Source Jewels, spread across the entirety of our Universe.

The idea of Schwinger Sources as more than mere points is in David Finkelstein’s Space-Time Code 1968 in which David said “... “... What is too simple about general relativity is the space-time point ... each point of space-time is some kind of assembly of some kind of thing ... Each point, as Feynman once put it, has to remember with precision the values of indefinitely many fields describing many elementary particles; has to have data inputs and outputs connected to neighboring points; has to have a little arithmetic element to satisfy the field equations; and all in all might just as well be a complete computer ...”.

First Generation Fermion Geometry:

First Generation (8) Fermions are represented by Octonions
with 8 basis elements { 1, i, j, k, E, I, J, K }

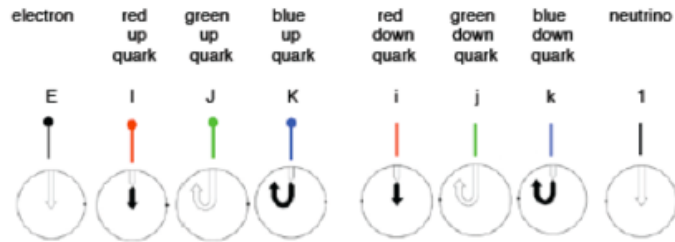

1 = 1 = Neutrino 3 = i, j, k = Down Quarks (r,g,b = 3)
1 = E = electron 3 = I, J, K = Up Quarks (r,g,b = 3)

Neutrino:

Volume in 4D Minkowski M4 is Complex Bounded Domain type IV4
with Symmetric Space Spin(6) / Spin(4)xU(1) Lie Ball
and Shilov Boundary RP1 x S3 Lie Sphere

Volume in 8D is Complex Bounded Domain type IV8
with Symmetric Space Spin(10) / Spin(8)xU(1) Lie Ball
and Shilov Boundary RP1 x S7 Lie Sphere

By Triality the 8D M4 Spacetime Shilov Boundary Lie Sphere
is isomorphic to the 8D CP2 Fermion Particle Symmetry Space
Lie Sphere RP1 x S7 Shilov Boundary
with basis {1,i,j,k,E,I,J,K} = {Nu,rDQ,gDQ,bDq,E,rUQ,gUQ,bUQ}
and to the corresponding
8D CP2 Fermion AntiParticle Symmetry Space

Conformal Gravity has 15 generators.

- 1 is the Dilaton corresponding to the Higgs
- 4 are Special Conformal corresponding to Dark Energy
- 10 are anti-deSitter for Einstein-Hilbert Gravity
 - 2 of the 10 are Cartan Subalgebra
 - 8 of the 10 can carry Charges
 - 6 of the 8 carry SU(3) Color Charge (R G B)
 - 2 of the 8 can carry U(2) ElectroWeak Charge (-1 +1)
 - 1 of the 2 carries Charge 0 of the Neutrino

which gives the Neutrino mass formula a Graviton factor of 0
so that the tree-level Neutrino mass is Zero.

The Neutrino is only related to the RP1 of S^7 x RP^1
because the Neutrino carries no Charge
so the Neutrino should have at tree level
a spinor manifold volume factor V(Qneutrino) of unit volume of Zero.

Electron:

Volume in 4D Minkowski M4 is Complex Bounded Domain type IV4
with Symmetric Space $\text{Spin}(6) / \text{Spin}(4) \times \text{U}(1)$ Lie Ball
and Shilov Boundary $\text{RP}^1 \times \text{S}^3$ Lie Sphere

Volume in 8D is Complex Bounded Domain type IV8
with Symmetric Space $\text{Spin}(10) / \text{Spin}(8) \times \text{U}(1)$ Lie Ball
and Shilov Boundary $\text{RP}^1 \times \text{S}^7$ Lie Sphere

By Triality the 8D M4 Spacetime Shilov Boundary Lie Sphere
is isomorphic to the 8D CP2 Fermion Particle Symmetry Space
Lie Sphere $\text{RP}^1 \times \text{S}^7$ Shilov Boundary
with basis $\{1, i, j, k, E, I, J, K\} = \{\text{Nu}, \text{rDQ}, \text{gDQ}, \text{bDq}, \text{E}, \text{rUQ}, \text{gUQ}, \text{bUQ}\}$
and
to the corresponding
8D CP2 Fermion AntiParticle Symmetry Space

Conformal Gravity has 15 generators.
1 is the Dilaton corresponding to the Higgs
4 are Special Conformal corresponding to Dark Energy
10 are anti-deSitter for Einstein-Hilbert Gravity
2 of the 10 are Cartan Subalgebra
8 of the 10 can carry Charges
6 of the 8 carry SU(3) Color Charge (R G B)
2 of the 8 can carry U(2) ElectroWeak Charge (-1 +1)
1 of the 2 carries Charge +1 of the Electron
which gives the Electron mass formula a Graviton factor of 1.

The Electron is only related to the equatorial $\text{S}^1 = \text{U}(1)$ of the S^7 of $\text{S}^7 \times \text{RP}^1$
because the Electron carries only U(1) ElectroWeak Charge
so
the Electron should have
a spinor manifold volume factor $V(\text{Qelectron})$ of unit volume of $\text{S}^1 = \text{U}(1)$.

Down Quark (either Red, Green, or Blue):

Volume in 4D Minkowski M4 is Complex Bounded Domain type IV4
with Symmetric Space Spin(6) / Spin(4)xU(1) Lie Ball
and Shilov Boundary RP1 x S3 Lie Sphere

Volume in 8D is Complex Bounded Domain type IV8
with Symmetric Space Spin(10) / Spin(8)xU(1) Lie Ball
and Shilov Boundary RP1 x S7 Lie Sphere

By Triality the 8D M4 Spacetime Shilov Boundary Lie Sphere
is isomorphic to the 8D CP2 Fermion Particle Symmetry Space
Lie Sphere RP1 x S7 Shilov Boundary
with basis $\{1, i, j, k, E, I, J, K\} = \{N_u, rDQ, gDQ, bDq, E, rUQ, gUQ, bUQ\}$
and

to the corresponding
8D CP2 Fermion AntiParticle Symmetry Space

Conformal Gravity has 15 generators.
1 is the Dilaton corresponding to the Higgs
4 are Special Conformal corresponding to Dark Energy
10 are anti-deSitter for Einstein-Hilbert Gravity
2 of the 10 are Cartan Subalgebra
8 of the 10 can carry Charges
6 of the 8 carry SU(3) Color Charge (R G B)
which gives the Down Quark mass formula a Graviton factor of 6.

The Down Quarks correspond to Octonions i, j, k
which, by gluon interactions, can be taken into each other.

By also using weak boson interactions,
they can also be taken into I, J, and K, the red, blue, and green Up Quarks.
Given the Up and Down quarks, Pions can be formed from quark-antiquark pairs,
and the Pions can decay to produce electrons and neutrinos.

Therefore the Down Quarks are related to all parts of $S^7 \times RP^1$,
the compact manifold corresponding to $\{1, i, j, k, E, I, J, K\}$
and therefore a Down Quark should have

a spinor manifold volume factor $V(Q_{\text{down quark}})$ of the volume of $S^7 \times RP^1$.

The ratio of the Down Quark spinor manifold volume factor
to the Electron spinor manifold volume factor is

$$V(Q_{\text{down quark}}) / V(Q_{\text{electron}}) = V(S^7 \times RP^1) / 1 = \pi^5 / 3.$$

Since the first generation graviton factor is 6 for Down Quarks and 1 for Electron
 $m_d / m_e = 6 V(S^7 \times RP^1) = 2 \pi^5 = 612.03937$

Up Quark (either Red, Green, or Blue):

Volume in 4D Minkowski M4 is Complex Bounded Domain type IV4
with Symmetric Space Spin(6) / Spin(4)xU(1) Lie Ball
and Shilov Boundary RP1 x S3 Lie Sphere

Volume in 8D is Complex Bounded Domain type IV8
with Symmetric Space Spin(10) / Spin(8)xU(1) Lie Ball
and Shilov Boundary RP1 x S7 Lie Sphere

By Triality the 8D M4 Spacetime Shilov Boundary Lie Sphere
is isomorphic to the 8D CP2 Fermion Particle Symmetry Space
Lie Sphere RP1 x S7 Shilov Boundary
with basis $\{1, i, j, k, E, I, J, K\} = \{N_u, rDQ, gDQ, bDq, E, rUQ, gUQ, bUQ\}$
and
to the corresponding
8D CP2 Fermion AntiParticle Symmetry Space

Conformal Gravity has 15 generators.
1 is the Dilaton corresponding to the Higgs
4 are Special Conformal corresponding to Dark Energy
10 are anti-deSitter for Einstein-Hilbert Gravity
2 of the 10 are Cartan Subalgebra
8 of the 10 can carry Charges
6 of the 8 carry SU(3) Color Charge (R G B)
which gives the Up Quark mass formula a Graviton factor of 6.

As the up quarks correspond to I, J, and K,
which are the octonion transforms under E of i, j, and k of the down quarks,
the up quarks and down quarks have the same constituent mass
 $\mu = m_d$.

Antiparticles have the same mass as the corresponding particles.

Since the model only gives ratios of masses,
the mass scale is fixed so that the electron mass $m_e = 0.5110$ MeV.
Then, the constituent mass of the down quark is $m_d = 312.75$ MeV,
and the constituent mass for the up quark is $\mu = 312.75$ MeV.
These results when added up give a total mass of first generation fermion particles:
 $\Sigma_{maf1} = 1.877$ GeV

Second and Third Generation Fermions:

Second Generation Fermions are represented by Pairs of Octonions
with $8 \times 8 = 64$ basis elements

$1 = \{11\} = \text{Mu Neutrino}$
 $3 = 2+1 = \{1E, E1, EE\} = \text{Muon}$
 $9 = 3 \times 3 = \{1r, r1, rr \text{ or } 1g, g1, gg \text{ or } 1b, b1, bb\} = \text{Strange Quarks (r,g,b = 3)}$
 $51 = 17 \times 3 = \text{Charm Quarks (r,g,b = 3)}$

Second Generation (64)

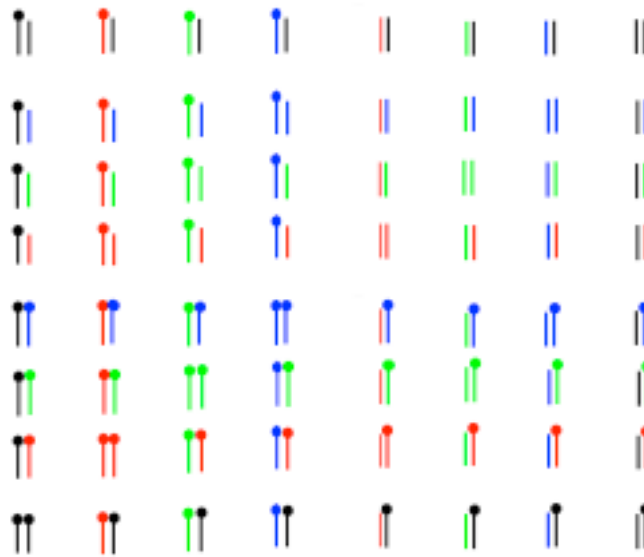

Mu Neutrino (1)

Rule: a Pair belongs to the Mu Neutrino if:
 All elements are Colorless (black)
 and all elements are Associative
 (that is, is 1 which is the only Colorless Associative element) .

Muon (3)

Rule: a Pair belongs to the Muon if:
 All elements are Colorless (black)
 and at least one element is NonAssociative
 (that is, is E which is the only Colorless NonAssociative element).

Blue Strange Quark (3)

Rule: a Pair belongs to the Blue Strange Quark if:
 There is at least one Blue element and the other element is Blue or Colorless (black)
 and all elements are Associative (that is, is either 1 or i or j or k).

Blue Charm Quark (17)

Rules: a Pair belongs to the Blue Charm Quark if:

- 1 - There is at least one Blue element and the other element is Blue or Colorless (black) and at least one element is NonAssociative (that is, is either E or I or J or K)
- 2 - There is one Red element and one Green element (Red x Green = Blue).

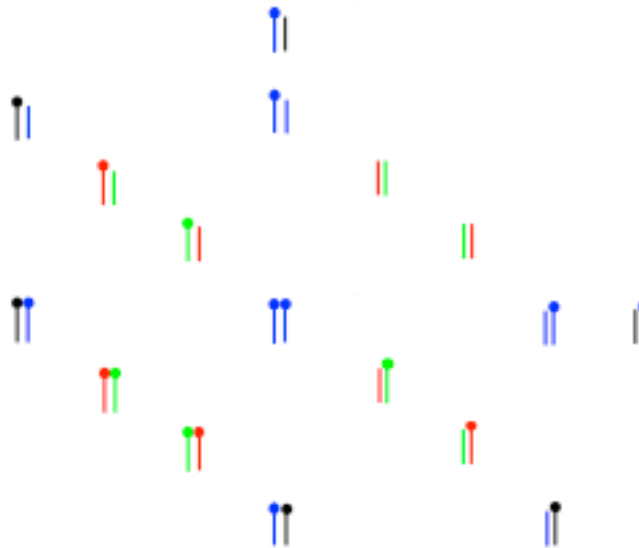

(Red and Green Strange and Charm Quarks follow similar rules)

In the $Cl(16) Cl(1,25) E8$ model, the first generation spinor fermions are seen as +half-spinor and -half-spinor spaces of $Cl(1,7) = Cl(8)$.

Due to Triality,

$Spin(8)$ can act on those 8-dimensional half-spinor spaces similarly to the way it acts on 8-dimensional vector spacetime.

Take the the spinor fermion volume to be the Shilov boundary corresponding to the same symmetric space on which $Spin(8)$ acts as a local gauge group that is used to construct 8-dimensional vector spacetime:

the symmetric space $Spin(10) / Spin(8) \times U(1)$

corresponding to a bounded domain of type IV8

whose Shilov boundary is $RP^1 \times S^7$

Since all first generation fermions see the spacetime over which the integral is taken in the same way (unlike what happens for the force strength calculation),

the only geometric volume factor relevant for calculating first generation fermion mass ratios is in the spinor fermion volume term.

Cl(1,25) E8 model fermions correspond to Schwinger Source Kerr-Newman Black Holes,

so the quark mass in the Cl(1,25) E8 model is a constituent mass.

Fermion masses are calculated as a product of four factors:

$$V(Q\text{fermion}) \times N(\text{Graviton}) \times N(\text{octonion}) \times \text{Sym}$$

$V(Q\text{fermion})$ is the volume of the part of the half-spinor fermion particle manifold $S^7 \times RP^1$ related to the fermion particle by photon, weak boson, or gluon interactions.

$N(\text{Graviton})$ is the number of types of Spin(0,5) graviton related to the fermion.

The 10 gravitons correspond to the 10 infinitesimal generators of Spin(0,5) = Sp(2). 2 of them are in the Cartan subalgebra.

6 of them carry color charge, and therefore correspond to quarks.

The remaining 2 carry no color charge, but may carry electric charge and so may be considered as corresponding to electrons.

One graviton takes the electron into itself, and the other can only take the first-generation electron into the massless electron neutrino. Therefore only one graviton should correspond to the mass of the first-generation electron. The graviton number ratio of the down quark to the first-generation electron is therefore $6/1 = 6$.

$N(\text{octonion})$ is an octonion number factor relating up-type quark masses to down-type quark masses in each generation.

Sym is an internal symmetry factor, relating 2nd and 3rd generation massive leptons to first generation fermions. It is not used in first-generation calculations.

The second generation fermion particles correspond to pairs of octonions.

There are $8^2 = 64$ such pairs.

The pair { 1, 1 } corresponds to the mu-neutrino.

The pairs { 1, E }, { E, 1 }, and { E, E } correspond to the muon.

For the Sym factor, compare the symmetries of the muon pairs to the symmetries of the first generation fermion particles:

The pair { E, E } should correspond to the E electron.

The other two muon pairs have a symmetry group S2, which is 1/3 the size of the color symmetry group S3 which gives the up and down quarks their mass of 312.75 MeV.

Therefore the mass of the muon should be the sum of the { E, E } electron mass and the { 1, E }, { E, 1 } symmetry mass,

which is 1/3 of the up or down quark mass. Therefore, $m_{\mu} = 104.76 \text{ MeV}$.

According to the 1998 Review of Particle Physics of the Particle Data Group, the experimental muon mass is about 105.66 MeV which may be consistent with radiative corrections for the calculated tree-level $m_{\mu} = 104.76 \text{ MeV}$ as Bailin and Love, in "Introduction to Gauge Field Theory", IOP (rev ed 1993), say: "... considering the order alpha radiative corrections to muon decay ... Numerical details are contained in Sirlin ... 1980 Phys. Rev. D 22 971 ... who concludes that the order alpha corrections have the effect of increasing the decay rate about 7% compared with the tree graph prediction ...". Since the decay rate is proportional to m_{μ}^5 the corresponding effective increase in muon mass would be about 1.36%, which would bring 104.8 MeV up to about 106.2 MeV.

All pairs corresponding to the muon and the mu-neutrino are colorless.

The red, blue and green strange quark each corresponds to the 3 pairs involving 1 and i, j, or k.

The red strange quark is defined as the three pairs $\{ 1, i \}$, $\{ i, 1 \}$, $\{ i, i \}$ because i is the red down quark.

Its mass should be the sum of two parts:

the $\{ i, i \}$ red down quark mass, 312.75 MeV, and

the product of the symmetry part of the muon mass, 104.25 MeV, times the graviton factor.

Unlike the first generation situation,

massive second and third generation leptons can be taken,

by both of the colorless gravitons that may carry electric charge, into massive particles.

Therefore the graviton factor for the second and third generations is $6/2 = 3$.

So the symmetry part of the muon mass times the graviton factor 3 is 312.75 MeV, and the red strange quark constituent mass is $m_s = 312.75 \text{ MeV} + 312.75 \text{ MeV} = 625.5 \text{ MeV}$

The blue strange quarks correspond to the three pairs involving j, the green strange quarks correspond to the three pairs involving k, and their masses are similarly determined to also be 625.5 MeV.

The charm quark corresponds to the remaining $64 - 1 - 3 - 9 = 51$ pairs.

Therefore, the mass of the red charm quark should be the sum of two parts:

the $\{ i, i \}$, red up quark mass, 312.75 MeV;

and

the product of the symmetry part of the strange quark mass, 312.75 MeV,

and the charm to strange octonion number factor $51 / 9$,

which product is 1,772.25 MeV.

Therefore the red charm quark constituent mass is
 $m_c = 312.75 \text{ MeV} + 1,772.25 \text{ MeV} = 2.085 \text{ GeV}$

The blue and green charm quarks are similarly determined to also be 2.085 GeV.

The calculated Charm Quark mass of 2.09 GeV is a constituent mass, that is, it corresponds to the conventional pole mass plus 312.8 MeV.

Therefore, the calculated Charm Quark mass of 2.09 GeV corresponds to a conventional pole mass of 1.78 GeV.

The 1996 Particle Data Group Review of Particle Physics gives a range for the Charm Quark pole mass from 1.2 to 1.9 GeV.

The pole mass can be converted to an MSbar mass if the color force strength constant α_s is known.

The conventional value of α_s at about 2 GeV is about 0.39, which is somewhat lower than the theoretical model value.

Using $\alpha_s(2 \text{ GeV}) = 0.39$, a pole mass of 1.9 GeV gives an MSbar 1-loop mass of 1.6 GeV, evaluated at about 2 GeV.

These results when added up give a total mass of second generation fermion particles:

$$\Sigma_{\text{mf}2} = 32.9 \text{ GeV}$$

Third Generation Fermions are represented by Triples of Octonions
with $8 \times 8 \times 8 = 512$ basis elements

$$1 = \{111\} = \text{Tau Neutrino}$$

$$7 = 3+3+1 = \{11E, 1E1, E11, EE1, E1E, 1EE, EEE\} = \text{Tauon}$$

$$21 = 7 \times 3 = \text{Beauty Quarks (r,g,b = 3)}$$

$$483 = 161 \times 3 = 23 \times 7 \times 3 = \text{Truth Quarks (r,g,b = 3)}$$

Third Generation (512)

	<table border="1"> <tr><td>111</td><td>11E</td><td>1E1</td><td>E11</td></tr> <tr><td>EE1</td><td>E1E</td><td>1EE</td><td>EEE</td></tr> <tr><td>111</td><td>11E</td><td>1E1</td><td>E11</td></tr> <tr><td>EE1</td><td>E1E</td><td>1EE</td><td>EEE</td></tr> <tr><td>111</td><td>11E</td><td>1E1</td><td>E11</td></tr> <tr><td>EE1</td><td>E1E</td><td>1EE</td><td>EEE</td></tr> <tr><td>111</td><td>11E</td><td>1E1</td><td>E11</td></tr> <tr><td>EE1</td><td>E1E</td><td>1EE</td><td>EEE</td></tr> </table>	111	11E	1E1	E11	EE1	E1E	1EE	EEE	111	11E	1E1	E11	EE1	E1E	1EE	EEE	111	11E	1E1	E11	EE1	E1E	1EE	EEE	111	11E	1E1	E11	EE1	E1E	1EE	EEE																																																																	
111	11E	1E1	E11																																																																																															
EE1	E1E	1EE	EEE																																																																																															
111	11E	1E1	E11																																																																																															
EE1	E1E	1EE	EEE																																																																																															
111	11E	1E1	E11																																																																																															
EE1	E1E	1EE	EEE																																																																																															
111	11E	1E1	E11																																																																																															
EE1	E1E	1EE	EEE																																																																																															
<table border="1"> <tr><td>111</td><td>11E</td><td>1E1</td><td>E11</td></tr> <tr><td>EE1</td><td>E1E</td><td>1EE</td><td>EEE</td></tr> <tr><td>111</td><td>11E</td><td>1E1</td><td>E11</td></tr> <tr><td>EE1</td><td>E1E</td><td>1EE</td><td>EEE</td></tr> <tr><td>111</td><td>11E</td><td>1E1</td><td>E11</td></tr> <tr><td>EE1</td><td>E1E</td><td>1EE</td><td>EEE</td></tr> <tr><td>111</td><td>11E</td><td>1E1</td><td>E11</td></tr> <tr><td>EE1</td><td>E1E</td><td>1EE</td><td>EEE</td></tr> </table>	111	11E	1E1	E11	EE1	E1E	1EE	EEE	111	11E	1E1	E11	EE1	E1E	1EE	EEE	111	11E	1E1	E11	EE1	E1E	1EE	EEE	111	11E	1E1	E11	EE1	E1E	1EE	EEE	<table border="1"> <tr><td>111</td><td>11E</td><td>1E1</td><td>E11</td></tr> <tr><td>EE1</td><td>E1E</td><td>1EE</td><td>EEE</td></tr> <tr><td>111</td><td>11E</td><td>1E1</td><td>E11</td></tr> <tr><td>EE1</td><td>E1E</td><td>1EE</td><td>EEE</td></tr> <tr><td>111</td><td>11E</td><td>1E1</td><td>E11</td></tr> <tr><td>EE1</td><td>E1E</td><td>1EE</td><td>EEE</td></tr> <tr><td>111</td><td>11E</td><td>1E1</td><td>E11</td></tr> <tr><td>EE1</td><td>E1E</td><td>1EE</td><td>EEE</td></tr> </table>	111	11E	1E1	E11	EE1	E1E	1EE	EEE	111	11E	1E1	E11	EE1	E1E	1EE	EEE	111	11E	1E1	E11	EE1	E1E	1EE	EEE	111	11E	1E1	E11	EE1	E1E	1EE	EEE	<table border="1"> <tr><td>111</td><td>11E</td><td>1E1</td><td>E11</td></tr> <tr><td>EE1</td><td>E1E</td><td>1EE</td><td>EEE</td></tr> <tr><td>111</td><td>11E</td><td>1E1</td><td>E11</td></tr> <tr><td>EE1</td><td>E1E</td><td>1EE</td><td>EEE</td></tr> <tr><td>111</td><td>11E</td><td>1E1</td><td>E11</td></tr> <tr><td>EE1</td><td>E1E</td><td>1EE</td><td>EEE</td></tr> <tr><td>111</td><td>11E</td><td>1E1</td><td>E11</td></tr> <tr><td>EE1</td><td>E1E</td><td>1EE</td><td>EEE</td></tr> </table>	111	11E	1E1	E11	EE1	E1E	1EE	EEE	111	11E	1E1	E11	EE1	E1E	1EE	EEE	111	11E	1E1	E11	EE1	E1E	1EE	EEE	111	11E	1E1	E11	EE1	E1E	1EE	EEE
111	11E	1E1	E11																																																																																															
EE1	E1E	1EE	EEE																																																																																															
111	11E	1E1	E11																																																																																															
EE1	E1E	1EE	EEE																																																																																															
111	11E	1E1	E11																																																																																															
EE1	E1E	1EE	EEE																																																																																															
111	11E	1E1	E11																																																																																															
EE1	E1E	1EE	EEE																																																																																															
111	11E	1E1	E11																																																																																															
EE1	E1E	1EE	EEE																																																																																															
111	11E	1E1	E11																																																																																															
EE1	E1E	1EE	EEE																																																																																															
111	11E	1E1	E11																																																																																															
EE1	E1E	1EE	EEE																																																																																															
111	11E	1E1	E11																																																																																															
EE1	E1E	1EE	EEE																																																																																															
111	11E	1E1	E11																																																																																															
EE1	E1E	1EE	EEE																																																																																															
111	11E	1E1	E11																																																																																															
EE1	E1E	1EE	EEE																																																																																															
111	11E	1E1	E11																																																																																															
EE1	E1E	1EE	EEE																																																																																															
111	11E	1E1	E11																																																																																															
EE1	E1E	1EE	EEE																																																																																															
<table border="1"> <tr><td>111</td><td>11E</td><td>1E1</td><td>E11</td></tr> <tr><td>EE1</td><td>E1E</td><td>1EE</td><td>EEE</td></tr> <tr><td>111</td><td>11E</td><td>1E1</td><td>E11</td></tr> <tr><td>EE1</td><td>E1E</td><td>1EE</td><td>EEE</td></tr> <tr><td>111</td><td>11E</td><td>1E1</td><td>E11</td></tr> <tr><td>EE1</td><td>E1E</td><td>1EE</td><td>EEE</td></tr> <tr><td>111</td><td>11E</td><td>1E1</td><td>E11</td></tr> <tr><td>EE1</td><td>E1E</td><td>1EE</td><td>EEE</td></tr> </table>	111	11E	1E1	E11	EE1	E1E	1EE	EEE	111	11E	1E1	E11	EE1	E1E	1EE	EEE	111	11E	1E1	E11	EE1	E1E	1EE	EEE	111	11E	1E1	E11	EE1	E1E	1EE	EEE	<table border="1"> <tr><td>111</td><td>11E</td><td>1E1</td><td>E11</td></tr> <tr><td>EE1</td><td>E1E</td><td>1EE</td><td>EEE</td></tr> <tr><td>111</td><td>11E</td><td>1E1</td><td>E11</td></tr> <tr><td>EE1</td><td>E1E</td><td>1EE</td><td>EEE</td></tr> <tr><td>111</td><td>11E</td><td>1E1</td><td>E11</td></tr> <tr><td>EE1</td><td>E1E</td><td>1EE</td><td>EEE</td></tr> <tr><td>111</td><td>11E</td><td>1E1</td><td>E11</td></tr> <tr><td>EE1</td><td>E1E</td><td>1EE</td><td>EEE</td></tr> </table>	111	11E	1E1	E11	EE1	E1E	1EE	EEE	111	11E	1E1	E11	EE1	E1E	1EE	EEE	111	11E	1E1	E11	EE1	E1E	1EE	EEE	111	11E	1E1	E11	EE1	E1E	1EE	EEE	<table border="1"> <tr><td>111</td><td>11E</td><td>1E1</td><td>E11</td></tr> <tr><td>EE1</td><td>E1E</td><td>1EE</td><td>EEE</td></tr> <tr><td>111</td><td>11E</td><td>1E1</td><td>E11</td></tr> <tr><td>EE1</td><td>E1E</td><td>1EE</td><td>EEE</td></tr> <tr><td>111</td><td>11E</td><td>1E1</td><td>E11</td></tr> <tr><td>EE1</td><td>E1E</td><td>1EE</td><td>EEE</td></tr> <tr><td>111</td><td>11E</td><td>1E1</td><td>E11</td></tr> <tr><td>EE1</td><td>E1E</td><td>1EE</td><td>EEE</td></tr> </table>	111	11E	1E1	E11	EE1	E1E	1EE	EEE	111	11E	1E1	E11	EE1	E1E	1EE	EEE	111	11E	1E1	E11	EE1	E1E	1EE	EEE	111	11E	1E1	E11	EE1	E1E	1EE	EEE
111	11E	1E1	E11																																																																																															
EE1	E1E	1EE	EEE																																																																																															
111	11E	1E1	E11																																																																																															
EE1	E1E	1EE	EEE																																																																																															
111	11E	1E1	E11																																																																																															
EE1	E1E	1EE	EEE																																																																																															
111	11E	1E1	E11																																																																																															
EE1	E1E	1EE	EEE																																																																																															
111	11E	1E1	E11																																																																																															
EE1	E1E	1EE	EEE																																																																																															
111	11E	1E1	E11																																																																																															
EE1	E1E	1EE	EEE																																																																																															
111	11E	1E1	E11																																																																																															
EE1	E1E	1EE	EEE																																																																																															
111	11E	1E1	E11																																																																																															
EE1	E1E	1EE	EEE																																																																																															
111	11E	1E1	E11																																																																																															
EE1	E1E	1EE	EEE																																																																																															
111	11E	1E1	E11																																																																																															
EE1	E1E	1EE	EEE																																																																																															
111	11E	1E1	E11																																																																																															
EE1	E1E	1EE	EEE																																																																																															
111	11E	1E1	E11																																																																																															
EE1	E1E	1EE	EEE																																																																																															
	<table border="1"> <tr><td>111</td><td>11E</td><td>1E1</td><td>E11</td></tr> <tr><td>EE1</td><td>E1E</td><td>1EE</td><td>EEE</td></tr> <tr><td>111</td><td>11E</td><td>1E1</td><td>E11</td></tr> <tr><td>EE1</td><td>E1E</td><td>1EE</td><td>EEE</td></tr> <tr><td>111</td><td>11E</td><td>1E1</td><td>E11</td></tr> <tr><td>EE1</td><td>E1E</td><td>1EE</td><td>EEE</td></tr> <tr><td>111</td><td>11E</td><td>1E1</td><td>E11</td></tr> <tr><td>EE1</td><td>E1E</td><td>1EE</td><td>EEE</td></tr> </table>	111	11E	1E1	E11	EE1	E1E	1EE	EEE	111	11E	1E1	E11	EE1	E1E	1EE	EEE	111	11E	1E1	E11	EE1	E1E	1EE	EEE	111	11E	1E1	E11	EE1	E1E	1EE	EEE																																																																	
111	11E	1E1	E11																																																																																															
EE1	E1E	1EE	EEE																																																																																															
111	11E	1E1	E11																																																																																															
EE1	E1E	1EE	EEE																																																																																															
111	11E	1E1	E11																																																																																															
EE1	E1E	1EE	EEE																																																																																															
111	11E	1E1	E11																																																																																															
EE1	E1E	1EE	EEE																																																																																															

Tau Neutrino (1)

Rule: a Triple belongs to the Tau Neutrino if:
All elements are Colorless (black)
and all elements are Associative
(that is, is 1 which is the only Colorless Associative element)

Tauon (7)

Rule: a Triple belongs to the Tauon if:

All elements are Colorless (black)

and at least one element is NonAssociative (that is, is E which is the only Colorless NonAssociative element)

Blue Beauty Quark (7)

Rule: a Triple belongs to the Blue Beauty Quark if:

There is at least one Blue element and all other elements are Blue or Colorless (black) and all elements are Associative (that is, is either 1 or i or j or k).

Blue Truth Quark (161)

Rules: a Triple belongs to the Blue Truth Quark if:

1 - There is at least one Blue element and all other elements are Blue or Colorless (black)

and at least one element is NonAssociative (that is, is either E or I or J or K)

2 - There is one Red element and one Green element and the other element is Colorless (Red x Green = Blue)

3 - The Triple has one element each that is Red, Green, or Blue, in which case the color of the Third element (for Third Generation) is determinative and must be Blue.

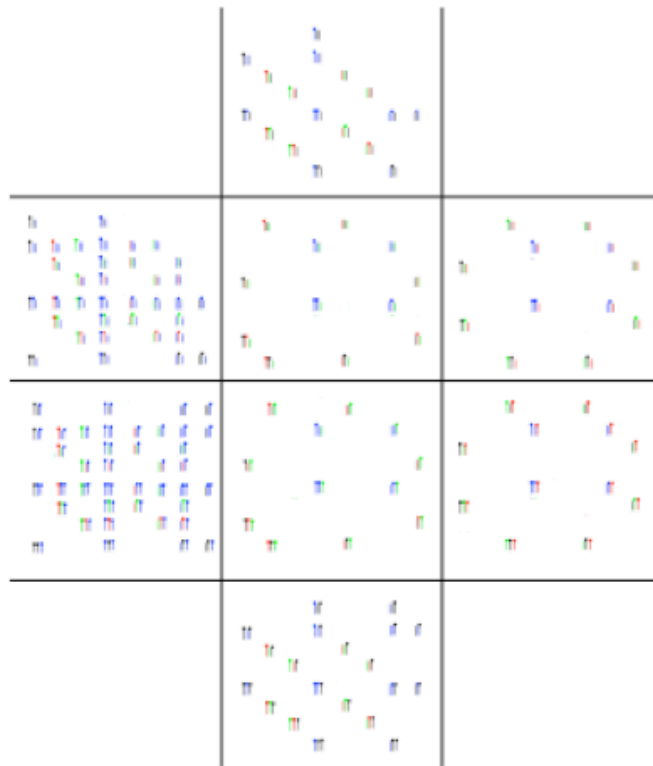

(Red and Green Beauty and Truth Quarks follow similar rules)

The third generation fermion particles correspond to triples of octonions. There are $8^3 = 512$ such triples.

The triple $\{ 1, 1, 1 \}$ corresponds to the tau-neutrino.

The other 7 triples involving only 1 and E correspond to the tauon:

$\{ E, E, E \}$
 $\{ E, E, 1 \}$
 $\{ E, 1, E \}$
 $\{ 1, E, E \}$
 $\{ 1, 1, E \}$
 $\{ 1, E, 1 \}$
 $\{ E, 1, 1 \}$

The symmetry of the 7 tauon triples is the same as the symmetry of the first generation tree-level-massive fermions, 3 down, quarks, the 3 up quarks, and the electron, so by the Sym factor the tauon mass should be the same as the sum of the masses of the first generation massive fermion particles.

Therefore the tauon mass is calculated at tree level as 1.877 GeV.

The calculated tauon mass of 1.88 GeV is a sum of first generation fermion masses, all of which are valid at the energy level of about 1 GeV.

However, as the tauon mass is about 2 GeV, the effective tauon mass should be renormalized from the energy level of 1 GeV at which the mass is 1.88 GeV to the energy level of 2 GeV. Such a renormalization should reduce the mass.

If the renormalization reduction were about 5 percent, the effective tauon mass at 2 GeV would be about 1.78 GeV. The 1996 Particle Data Group Review of Particle Physics gives a tauon mass of 1.777 GeV.

All triples corresponding to the tau and the tau-neutrino are colorless.

The beauty quark corresponds to 21 triples. They are triples of the same form as the 7 tauon triples involving 1 and E, but for 1 and I, 1 and J, and 1 and K, which correspond to the red, green, and blue beauty quarks, respectively.

The seven red beauty quark triples correspond to the seven tauon triples, except that the beauty quark interacts with 6 Spin(0,5) gravitons while the tauon interacts with only two.

The red beauty quark constituent mass should be the tauon mass times the third generation graviton factor $6/2 = 3$, so the red beauty quark mass is $m_b = 5.63111 \text{ GeV}$.

The blue and green beauty quarks are similarly determined to also be 5.63111 GeV .

The calculated beauty quark mass of 5.63 GeV is a constituent mass, that is, it corresponds to the conventional pole mass plus 312.8 MeV . Therefore, the calculated beauty quark mass of 5.63 GeV corresponds to a conventional pole mass of 5.32 GeV .

The 1996 Particle Data Group Review of Particle Physics gives a lattice gauge theory beauty quark pole mass as 5.0 GeV .

The pole mass can be converted to an MSbar mass if the color force strength constant α_s is known. The conventional value of α_s at about 5 GeV is about 0.22 .

Using $\alpha_s(5 \text{ GeV}) = 0.22$, a pole mass of 5.0 GeV gives an MSbar 1-loop beauty quark mass of 4.6 GeV , and an MSbar 1,2-loop beauty quark mass of 4.3 , evaluated at about 5 GeV .

If the MSbar mass is run from 5 GeV up to 90 GeV , the MSbar mass decreases by about 1.3 GeV , giving an expected MSbar mass of about 3.0 GeV at 90 GeV .

DELPHI at LEP has observed the Beauty Quark and found a 90 GeV MSbar beauty quark mass of about 2.67 GeV , with error bars ± 0.25 (stat) ± 0.34 (frag) ± 0.27 (theo).

The theoretical model calculated Beauty Quark mass of 5.63 GeV corresponds to a pole mass of 5.32 GeV, which is somewhat higher than the conventional value of 5.0 GeV.

However, the theoretical model calculated value of the color force strength constant α_s at about 5 GeV is about 0.166, while the conventional value of the color force strength constant α_s at about 5 GeV is about 0.216, and the theoretical model calculated value of the color force strength constant α_s at about 90 GeV is about 0.106, while the conventional value of the color force strength constant α_s at about 90 GeV is about 0.118.

The theoretical model calculations gives a Beauty Quark pole mass (5.3 GeV) that is about 6 percent higher than the conventional Beauty Quark pole mass (5.0 GeV), and a color force strength α_s at 5 GeV (0.166) such that $1 + \alpha_s = 1.166$ is about 4 percent lower than the conventional value of $1 + \alpha_s = 1.216$ at 5 GeV.

Triples of the type $\{ 1, I, J \}$, $\{ I, J, K \}$, etc., do not correspond to the beauty quark, but to the truth quark. The truth quark corresponds to those $512 - 1 - 7 - 21 = 483$ triples, so the constituent mass of the red truth quark is $161 / 7 = 23$ times the red beauty quark mass, and the red T-quark mass is $m_t = 129.5155$ GeV

The blue and green truth quarks are similarly determined to also be 129.5155 GeV.

This is the value of the Low Mass State of the Truth calculated in the Cl(1,25) E8 model. The Middle Mass State of the Truth Quark has been observed by Fermilab since 1994. The Low and High Mass States of the Truth Quark have, in my opinion, also been observed by Fermilab (see Chapter 17 of this paper) but the Fermilab and CERN establishments disagree.

All other masses than the electron mass (which is the basis of the assumption of the value of the Higgs scalar field vacuum expectation value $v = 252.514$ GeV), including the Higgs scalar mass and Truth quark mass, are calculated (not assumed) masses in the Cl(1,25) E8 model. These results when added up give a total mass of third generation fermion particles:

$$\mathbf{\Sigma_{maf3} = 1,629 \text{ GeV}}$$

Kobayashi-Maskawa Parameters

In E8 Physics the KM Unitarity Triangle angles can be seen on the Stella Octangula

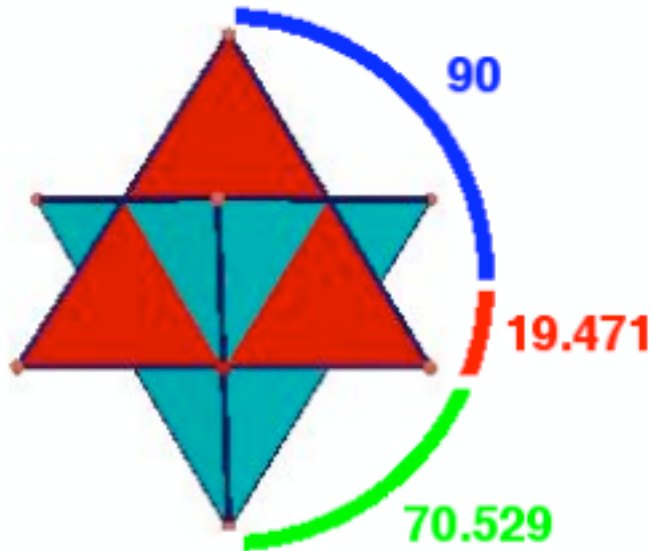

The Kobayashi-Maskawa parameters are determined in terms of the sum of the masses of the 30 first-generation fermion particles and antiparticles, denoted by

$$S_{mf1} = 7.508 \text{ GeV},$$

and the similar sums for second-generation and third-generation fermions, denoted by

$$S_{mf2} = 32.94504 \text{ GeV and } S_{mf3} = 1,629.2675 \text{ GeV}.$$

The resulting KM matrix is:

d		s	b
u	0.975	0.222 0.00249	-0.00388i
c	-0.222 -0.000161i	0.974 -0.0000365i	0.0423
t	0.00698 -0.00378i	-0.0418 -0.00086i	0.999

**Below the energy level of ElectroWeak Symmetry Breaking
the Higgs mechanism gives mass to particles.**

According to a Review on the Kobayashi-Maskawa mixing matrix by Ceccucci, Ligeti, and Sakai in the 2010 Review of Particle Physics (note that I have changed their terminology of CKM matrix to the KM terminology that I prefer because I feel that it was Kobayashi and Maskawa, not Cabibbo, who saw that 3x3 was the proper matrix structure): "... the charged-current W_{\pm} interactions couple to the ... quarks with couplings given by ...

$$\begin{matrix} V_{ud} & V_{us} & V_{ub} \\ V_{cd} & V_{cs} & V_{cb} \\ V_{td} & V_{ts} & V_{tb} \end{matrix}$$

This Kobayashi-Maskawa (KM) matrix is a 3x3 unitary matrix. It can be parameterized by three mixing angles and the CP-violating KM phase ... The most commonly used unitarity triangle arises from $V_{ud} V_{ub}^* + V_{cd} V_{cb}^* + V_{td} V_{tb}^* = 0$, by dividing each side by the best-known one, $V_{cd} V_{cb}^*$

... $\bar{\rho} + i\bar{\eta} = -(V_{ud} V_{ub}^*)/(V_{cd} V_{cb}^*)$ is phase-convention-independent ...

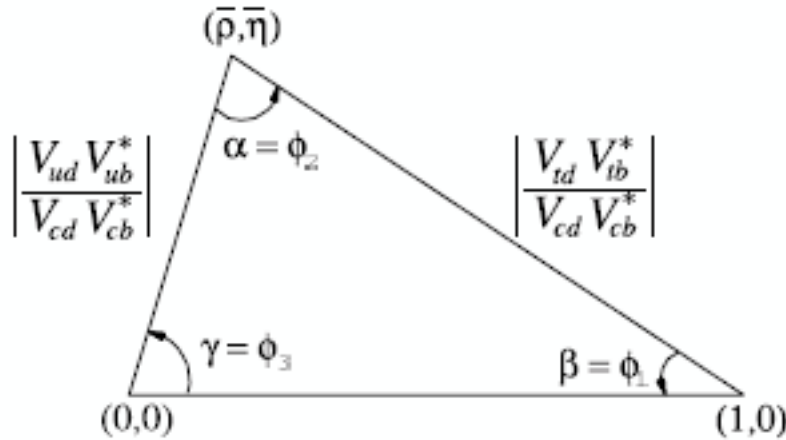

Figure 11.1: Sketch of the unitarity triangle.

... $\sin 2\beta = 0.673 \pm 0.023$... $\alpha = 89.0 +4.4 -4.2$ degrees ... $\gamma = 73 +22 -25$ degrees ... The sum of the three angles of the unitarity triangle, $\alpha + \beta + \gamma = (183 +22 -25)$ degrees, is ... consistent with the SM expectation. ...

The area... of ...[the]... triangle...[is]... half of the Jarlskog invariant, J , which is a phase-convention-independent measure of CP violation, defined by $\text{Im } V_{ij} V_{kl} V_{il}^* V_{kj}^* = J \sum(m,n) \epsilon_{ikm} \epsilon_{jln}$

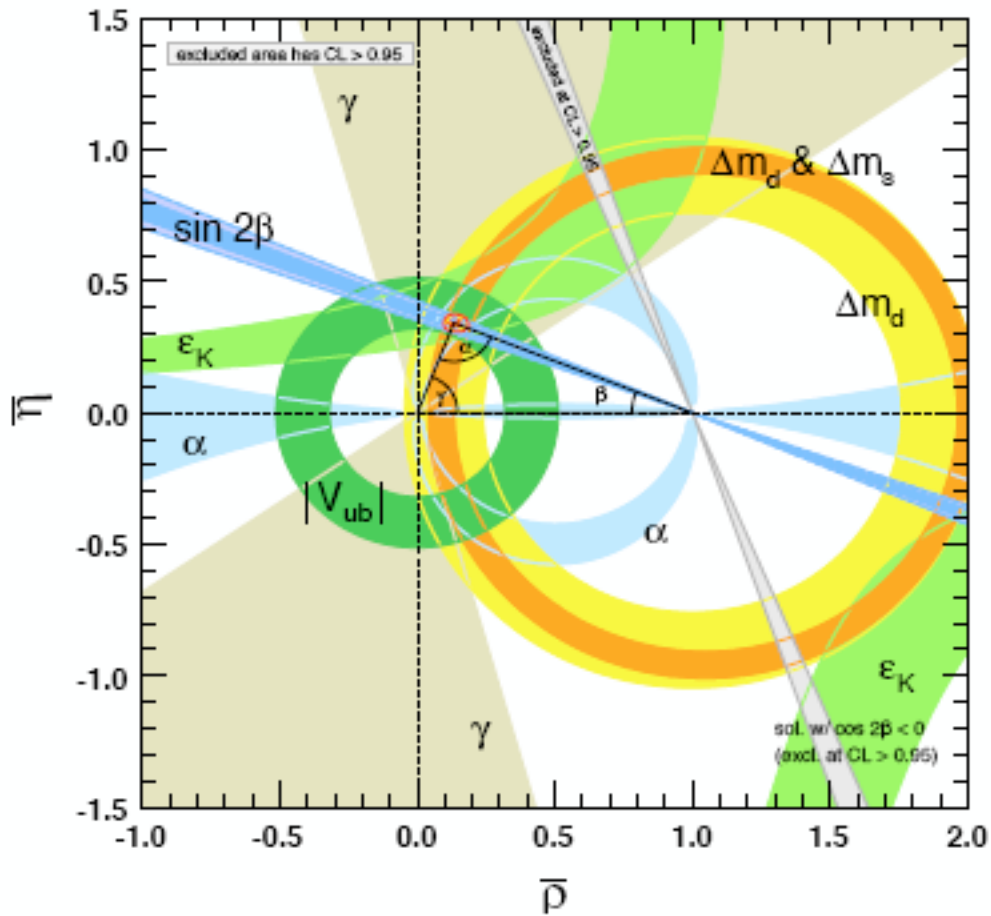

Figure 11.2: Constraints on the $\bar{\rho}, \bar{\eta}$ plane.
The shaded areas have 95% CL.

The fit results for the magnitudes of all nine KM elements are ...

0.97428 ± 0.00015	0.2253 ± 0.0007	$0.00347 +0.00016 -0.00012$
0.2252 ± 0.0007	$0.97345 +0.00015 -0.00016$	$0.0410 +0.0011 -0.0007$
$0.00862 +0.00026 -0.00020$	$0.0403 +0.0011 -0.0007$	$0.999152 +0.000030 -0.000045$

and the Jarlskog invariant is $J = (2.91 +0.19 -0.11) \times 10^{-5}$".

**Above the energy level of ElectroWeak Symmetry Breaking
particles are massless.**

Kea (Marni Sheppeard) proposed
that in the Massless Realm the mixing matrix might be democratic.
In Z. Phys. C - Particles and Fields 45, 39-41 (1989) Koide said: "...
the mass matrix ... MD ... of the type ... $1/3 \times m \times$

$$\begin{matrix} 1 & 1 & 1 \\ 1 & 1 & 1 \\ 1 & 1 & 1 \end{matrix}$$

... has name... "democratic" family mixing ...
the ... democratic ... mass matrix can be diagonalized by the transformation matrix A ...

$$\begin{matrix} 1/\sqrt{2} & -1/\sqrt{2} & 0 \\ 1/\sqrt{6} & 1/\sqrt{6} & -2/\sqrt{6} \\ 1/\sqrt{3} & 1/\sqrt{3} & 1/\sqrt{3} \end{matrix}$$

as $A MD A^t =$

$$\begin{matrix} 0 & 0 & 0 \\ 0 & 0 & 0 \\ 0 & 0 & m \end{matrix}$$

...".

Up in the Massless Realm you might just say that there is no mass matrix,
just a democratic mixing matrix of the form $1/3 \times$

$$\begin{matrix} 1 & 1 & 1 \\ 1 & 1 & 1 \\ 1 & 1 & 1 \end{matrix}$$

with no complex stuff and no CP violation in the Massless Realm.

When go down to our Massive Realm by ElectroWeak Symmetry Breaking
then you might as a first approximation use $m = 1$
so that all the mass first goes to the third generation as

$$\begin{matrix} 0 & 0 & 0 \\ 0 & 0 & 0 \\ 0 & 0 & 1 \end{matrix}$$

which is physically like the Higgs being a T-Tbar quark condensate.

Consider a 3-dim Euclidean space of generations:

The case of mass only going to one generation
can be represented as a line or 1-dimensional simplex



in which the blue mass-line covers the entire black simplex line.

If mass only goes to one other generation
that can be represented by a red line extending to a second dimension
forming a small blue-red-black triangle

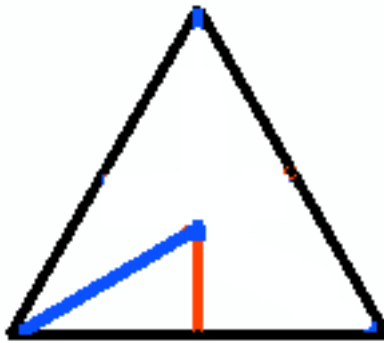

that can be extended by reflection to form six small triangles making up a large triangle

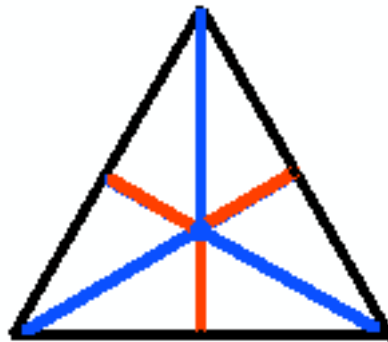

Each of the six component triangles has 30-60-90 angle structure:



If mass goes on further to all three generations that can be represented by a green line extending to a third dimension

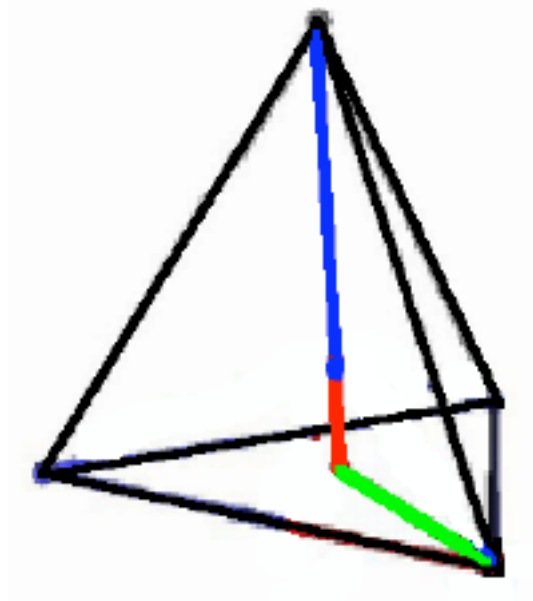

If you move the blue line from the top vertex to join the green vertex

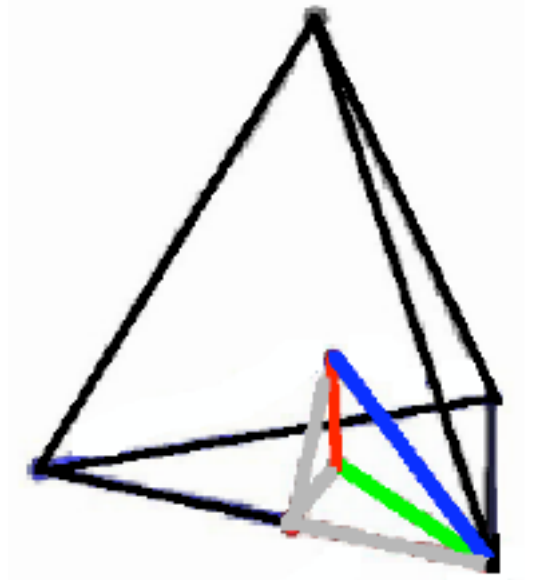

you get a small blue-red-green-gray-gray-gray tetrahedron that can be extended by reflection to form 24 small tetrahedra making up a large tetrahedron.

Reflection among the 24 small tetrahedra corresponds to the $12+12 = 24$ elements of the Binary Tetrahedral Group.

The basic blue-red-green triangle of the basic small tetrahedron

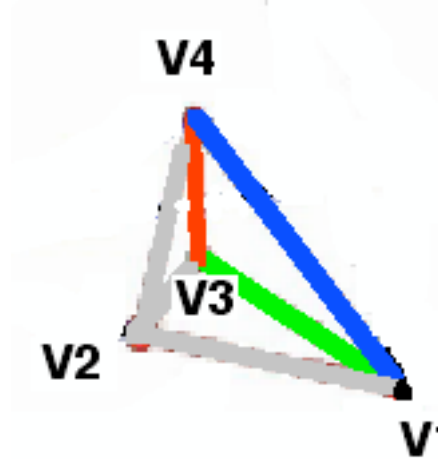

has the angle structure of the K-M Unitary Triangle.

Using data from R. W. Gray's "Encyclopedia Polyhedra: A Quantum Module" with lengths

$V1.V2 = (1/2) EL \cong$ Half of the regular Tetrahedron's edge length.

$V1.V3 = (1 / \sqrt{3}) EL \cong 0.577\ 350\ 269\ EL$

$V1.V4 = 3 / (2 \sqrt{6}) EL \cong 0.612\ 372\ 436\ EL$

$V2.V3 = 1 / (2 \sqrt{3}) EL \cong 0.288\ 675\ 135\ EL$

$V2.V4 = 1 / (2 \sqrt{2}) EL \cong 0.353\ 553\ 391\ EL$

$V3.V4 = 1 / (2 \sqrt{6}) EL \cong 0.204\ 124\ 145\ EL$

the Unitarity Triangle angles are:

$\beta = V3.V1.V4 = \arccos(2 \sqrt{2} / 3) \cong 19.471\ 220\ 634\ \text{degrees}$ so $\sin 2\beta = 0.6285$

$\alpha = V1.V3.V4 = 90\ \text{degrees}$

$\gamma = V1.V4.V3 = \arcsin(2 \sqrt{2} / 3) \cong 70.528\ 779\ 366\ \text{degrees}$

which is substantially consistent with the 2010 Review of Particle Properties

$\sin 2\beta = 0.673 \pm 0.023$ so $\beta = 21.1495\ \text{degrees}$

$\alpha = 89.0 +4.4 -4.2\ \text{degrees}$

$\gamma = 73 +22 -25\ \text{degrees}$

and so also consistent with the Standard Model expectation.

The constructed Unitarity Triangle angles can be seen on the Stella Octangula configuration of two dual tetrahedra (image from gauss.math.nthu.edu.tw):

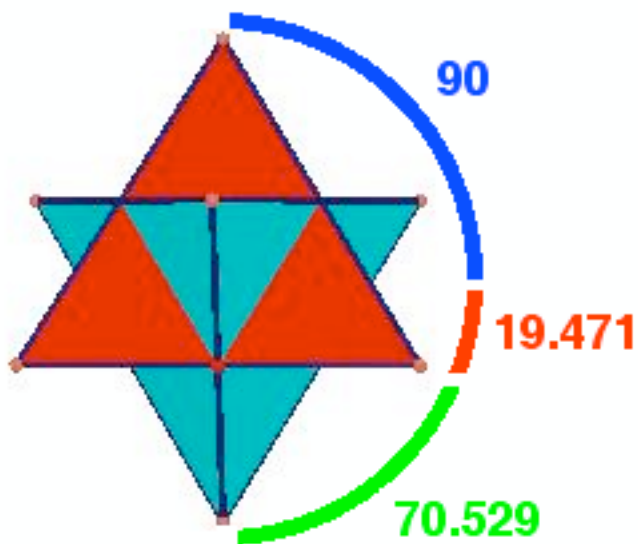

In the $Cl(1,25)$ E_8 model the Kobayashi-Maskawa parameters are determined in terms of the sum of the masses of the 30 first-generation fermion particles and antiparticles, denoted by $S_{mf1} = 7.508$ GeV,

and the similar sums for second-generation and third-generation fermions, denoted by $S_{mf2} = 32.94504$ GeV and $S_{mf3} = 1,629.2675$ GeV.

The reason for using sums of all fermion masses (rather than sums of quark masses only) is that all fermions are in the same spinor representation of $Spin(8)$, and the $Spin(8)$ representations are considered to be fundamental.

The following formulas use the above masses to calculate Kobayashi-Maskawa parameters:

phase angle $d_{13} = \gamma = 70.529$ degrees

$$\sin(\theta_{12}) = s_{12} = [m_e + 3m_d + 3m_\mu] / \sqrt{[m_e^2 + 3m_d^2 + 3m_\mu^2] + [3m_\nu^2 + 3m_s^2 + 3m_c^2]} = 0.222198$$

$$\sin(\theta_{13}) = s_{13} = [m_e + 3m_d + 3m_\mu] / \sqrt{[m_e^2 + 3m_d^2 + 3m_\mu^2] + [3m_\nu^2 + 3m_b^2 + 3m_t^2]} = 0.004608$$

$$\sin(\theta_{23}) = [3m_\nu + 3m_s + 3m_c] / \sqrt{[3m_\nu^2 + 3m_b^2 + 3m_t^2] + [3m_\nu^2 + 3m_s^2 + 3m_c^2]}$$

$$\sin(\theta_{23}) = s_{23} = \sin(\theta_{23}) \sqrt{(\sigma_{f2} / \sigma_{f1})} = 0.04234886$$

The factor $\sqrt{(\sigma_{f2} / \sigma_{f1})}$ appears in s_{23} because an s_{23} transition is to the second generation and not all the way to the first generation, so that the end product of an s_{23} transition has a greater available energy than s_{12} or s_{13} transitions by a factor of $\sigma_{f2} / \sigma_{f1}$.

Since the width of a transition is proportional to the square of the modulus of the relevant KM entry and the width of an s_{23} transition has greater available energy than the s_{12} or s_{13} transitions by a factor of $\sigma_{f2} / \sigma_{f1}$ the effective magnitude of the s_{23} terms in the KM entries is increased by the factor $\sqrt{(\sigma_{f2} / \sigma_{f1})}$.

The Chau-Keung parameterization is used, as it allows the K-M matrix to be represented as the product of the following three 3x3 matrices:

$$\begin{pmatrix} 1 & 0 & 0 \\ 0 & \cos(\theta_{23}) & \sin(\theta_{23}) \\ 0 & -\sin(\theta_{23}) & \cos(\theta_{23}) \end{pmatrix}$$

$$\begin{pmatrix} \cos(\theta_{13}) & 0 & \sin(\theta_{13})\exp(-i d_{13}) \\ 0 & 1 & 0 \\ -\sin(\theta_{13})\exp(i d_{13}) & 0 & \cos(\theta_{13}) \end{pmatrix}$$

$$\begin{pmatrix} \cos(\theta_{12}) & \sin(\theta_{12}) & 0 \\ -\sin(\theta_{12}) & \cos(\theta_{12}) & 0 \\ 0 & 0 & 1 \end{pmatrix}$$

The resulting Kobayashi-Maskawa parameters
for W^+ and W^- charged weak boson processes, are:

	d	s	b
u	0.975	0.222	0.00249 -0.00388i
c	-0.222 -0.000161i	0.974 -0.0000365i	0.0423
t	0.00698 -0.00378i	-0.0418 -0.00086i	0.999

The matrix is labelled by either (u c t) input and (d s b) output,
or, as above, (d s b) input and (u c t) output.

For Z^0 neutral weak boson processes, which are suppressed by the GIM
mechanism of cancellation of virtual subprocesses, the matrix is labelled by either
(u c t) input and (u'c't') output, or, as below, (d s b) input and (d's'b') output:

	d	s	b
d'	0.975	0.222	0.00249 -0.00388i
s'	-0.222 -0.000161i	0.974 -0.0000365i	0.0423
b'	0.00698 -0.00378i	-0.0418 -0.00086i	0.999

Since neutrinos of all three generations are massless at tree level,
the lepton sector has no tree-level K-M mixing.

In hep-ph/0208080, Yosef Nir says: "... Within the Standard Model,
the only source of CP violation is the Kobayashi-Maskawa (KM) phase ...
The study of CP violation is, at last, experiment driven. ...
The CKM matrix provides a consistent picture
of all the measured flavor and CP violating processes. ...
There is no signal of new flavor physics. ...
Very likely,
the KM mechanism is the dominant source of CP violation in flavor changing processes.
... The result is consistent with the SM predictions. ...".

Neutrino Masses Beyond Tree Level

Consider the three generations of neutrinos:
nu_e (electron neutrino); nu_mu (muon neutrino); nu_tau
and three neutrino mass states: nu_1 ; nu_2 : nu_3
and
the division of 8-dimensional spacetime into
4-dimensional physical Minkowski spacetime
plus
4-dimensional CP2 internal symmetry space.

The heaviest mass state nu_3 corresponds to a neutrino
whose propagation begins and ends in CP2 internal symmetry
space, lying entirely therein. According to the Cl(1,25) E8 model
the mass of nu_3 is zero at tree-level
but it picks up a first-order correction
propagating entirely through internal symmetry space by merging
with an electron through the weak and electromagnetic forces,
effectively acting not merely as a point
but
as a point plus an electron loop at beginning and ending points
so
the first-order corrected mass of nu_3 is given by
 $M_{\nu_3} \times (1/\sqrt{2}) = M_e \times GW(m_{\text{proton}}^2) \times \alpha_E$
where the factor $(1/\sqrt{2})$ comes from the Ut3 component
of the neutrino mixing matrix
so that

$$\begin{aligned} M_{\nu_3} &= \sqrt{2} \times M_e \times GW(m_{\text{proton}}^2) \times \alpha_E = \\ &= 1.4 \times 5 \times 10^5 \times 1.05 \times 10^{(-5)} \times (1/137) \text{ eV} = \\ &= 7.35 / 137 = 5.4 \times 10^{(-2)} \text{ eV}. \end{aligned}$$

The neutrino-plus-electron loop can be anchored by weak force
action through any of the 6 first-generation quarks
at each of the beginning and ending points, and that the
anchor quark at the beginning point can be different from
the anchor quark at the ending point,
so that there are $6 \times 6 = 36$ different possible anchorings.

The intermediate mass state ν_2 corresponds to a neutrino whose propagation begins or ends in CP2 internal symmetry space and ends or begins in M4 physical Minkowski spacetime, thus having only one point (either beginning or ending) lying in CP2 internal symmetry space where it can act not merely as a point but as a point plus an electron loop.

According to the Cl(1,25) E8 model the mass of ν_2 is zero at tree-level but it picks up a first-order correction at only one (but not both) of the beginning or ending points so that so that there are 6 different possible anchorings for ν_2 first-order corrections, as opposed to the 36 different possible anchorings for ν_3 first-order corrections, so that the first-order corrected mass of ν_2 is less than the first-order corrected mass of ν_3 by a factor of 6, so

the first-order corrected mass of ν_2 is
$$M_{\nu_2} = M_{\nu_3} / \text{Vol}(\text{CP}2) = 5.4 \times 10^{(-2)} / 6$$
$$= 9 \times 10^{(-3)} \text{eV}.$$

The low mass state ν_1 corresponds to a neutrino whose propagation begins and ends in physical Minkowski spacetime. thus having only one anchoring to CP2 interna symmetry space.

According to the Cl(1,25) E8 model the mass of ν_1 is zero at tree-level but it has only 1 possible anchoring to CP2 as opposed to the 36 different possible anchorings for ν_3 first-order corrections or the 6 different possible anchorings for ν_2 first-order corrections so that the first-order corrected mass of ν_1 is less than the first-order corrected mass of ν_2 by a factor of 6, so

the first-order corrected mass of ν_1 is
$$M_{\nu_1} = M_{\nu_2} / \text{Vol}(\text{CP}2) = 9 \times 10^{(-3)} / 6$$
$$= 1.5 \times 10^{(-3)} \text{eV}.$$

Therefore:

$$\begin{aligned} \text{the mass-squared difference } D(M_{23}^2) &= M_{\nu_3}^2 - M_{\nu_2}^2 = \\ &= (2916 - 81) \times 10^{-6} \text{ eV}^2 = \\ &= 2.8 \times 10^{-3} \text{ eV}^2 \end{aligned}$$

and

$$\begin{aligned} \text{the mass-squared difference } D(M_{12}^2) &= M_{\nu_2}^2 - M_{\nu_1}^2 = \\ &= (81 - 2) \times 10^{-6} \text{ eV}^2 = \\ &= 7.9 \times 10^{-5} \text{ eV}^2 \end{aligned}$$

The 3x3 unitary neutrino mixing matrix neutrino mixing matrix U

	nu_1	nu_2	nu_3
nu_e	Ue1	Ue2	Ue3
nu_mu	Um1	Um2	Um3
nu_tau	Ut1	Ut2	Ut3

can be parameterized (based on the 2010 Particle Data Book)
by 3 angles and 1 Dirac CP violation phase

$$U = \begin{pmatrix} c_{12} c_{13} & s_{12} c_{13} & s_{13} e^{-i\delta} \\ -s_{12} c_{23} - c_{12} s_{23} s_{13} e^{i\delta} & c_{12} c_{23} - s_{12} s_{23} s_{13} e^{i\delta} & s_{23} c_{13} \\ s_{12} s_{23} - c_{12} c_{23} s_{13} e^{i\delta} & -c_{12} s_{23} - s_{12} c_{23} s_{13} e^{i\delta} & c_{23} c_{13} \end{pmatrix}$$

where $c_{ij} = \cos(\theta_{ij})$, $s_{ij} = \sin(\theta_{ij})$

The angles are

$\theta_{23} = \pi/4 = 45$ degrees

because

ν_3 has equal components of ν_m and ν_t so
that $U_{m3} = U_{t3} = 1/\sqrt{2}$ or, in conventional
notation, mixing angle $\theta_{23} = \pi/4$

so that $\cos(\theta_{23}) = 0.707 = \sqrt{2}/2 = \sin(\theta_{23})$

$\theta_{13} = 9.594$ degrees = $\arcsin(1/6)$

and $\cos(\theta_{13}) = 0.986$

because $\sin(\theta_{13}) = 1/6 = 0.167 = |U_{e3}|$ = fraction of ν_3 that is ν_e

$\theta_{12} = \pi/6 = 30$ degrees

because

$\sin(\theta_{12}) = 0.5 = 1/2 = U_{e2}$ = fraction of ν_2 begin/end points
that are in the physical spacetime where massless ν_e lives

so that $\cos(\theta_{12}) = 0.866 = \sqrt{3}/2$

$\delta = 70.529$ degrees is the Dirac CP violation phase

$e^{i(70.529)} = \cos(70.529) + i \sin(70.529) = 0.333 + 0.943 i$

This is because the neutrino mixing matrix has 3-generation structure

and so has the same phase structure as the KM quark mixing matrix

in which the Unitarity Triangle angles are:

$\beta = V_3.V_1.V_4 = \arccos(2 \sqrt{2} / 3) \cong 19.471 220 634$ degrees so $\sin 2\beta = 0.6285$

$\alpha = V_1.V_3.V_4 = 90$ degrees

$\gamma = V_1.V_4.V_3 = \arcsin(2 \sqrt{2} / 3) \cong 70.528 779 366$ degrees

The constructed Unitarity Triangle angles can be seen on the Stella Octangula configuration of two dual tetrahedra (image from gauss.math.nthu.edu.tw):

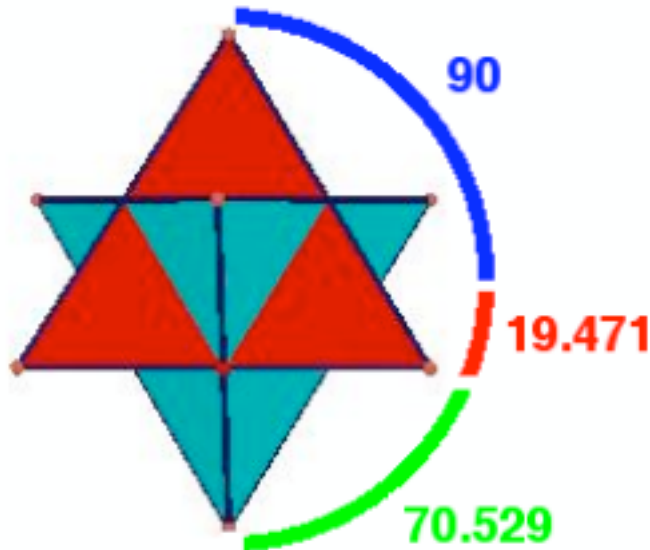

Then we have for the neutrino mixing matrix:

	nu_1	nu_2	nu_3
nu_e	0.866 x 0.986	0.50 x 0.986	0.167 x e-id
nu_m	-0.5 x 0.707 -0.866 x 0.707 x 0.167 x eid	0.866 x 0.707 -0.5 x 0.707 x 0.167 x eid	0.707 x 0.986
nu_t	0.5 x 0.707 -0.866 x 0.707 x 0.167 x eid	-0.866 x 0.707 -0.5 x 0.707 x 0.167 x eid	0.707 x 0.986

	nu_1	nu_2	nu_3
nu_e	0.853	0.493	0.167 e-id
nu_m	-0.354 -0.102 eid	0.612 -0.059 eid	0.697
nu_t	0.354 -0.102 eid	-0.612 -0.059 eid	0.697

Since $e^{i(70.529)} = \cos(70.529) + i \sin(70.529) = 0.333 + 0.943 i$
and $.333e^{-i(70.529)} = \cos(70.529) - i \sin(70.529) = 0.333 - 0.943 i$

	nu_1	nu_2	nu_3
nu_e	0.853	0.493	0.056 - 0.157 i
nu_m	-0.354 -0.034 - 0.096 i	0.612 -0.020 - 0.056 i	0.697
nu_t	0.354 -0.034 - 0.096 i	-0.612 -0.020 - 0.056 i	0.697

for a result of

	nu_1	nu_2	nu_3
nu_e	0.853	0.493	0.056 - 0.157 i
nu_m	-0.388 - 0.096 i	0.592 - 0.056 i	0.697
nu_t	0.320 - 0.096 i	0.632 - 0.056 i	0.697

which is consistent with the approximate experimental values of mixing angles shown in the Michaelmas Term 2010 Particle Physics handout of Prof Mark Thomson if the matrix is modified by taking into account the March 2012 results from Daya Bay observing non-zero $\theta_{13} = 9.54$ degrees.

Proton-Neutron Mass Difference

The proton mass is taken to be
the sum of the constituent masses of its constituent quarks

so

$$m_{\text{proton}} = m_u + m_u + m_d = 938.25 \text{ MeV}$$

which is close to the experimental value of 938.27 MeV.

An up valence quark, constituent mass 313 MeV,
does not often swap places with a 2.09 GeV charm sea quark,
but
a 313 MeV down valence quark
can more often swap places with a 625 MeV strange sea quark.

Therefore the Quantum color force
constituent mass of the down valence quark is heavier by about

$$(m_s - m_d) (m_d/m_s)^2 a(w) |V_{ds}| = 312 \times 0.25 \times 0.253 \times 0.22 \text{ MeV} = 4.3 \text{ MeV},$$

(where $a(w) = 0.253$ is the geometric part of the weak force strength
and $|V_{ds}| = 0.22$ is the magnitude
of the K-M parameter mixing first generation down and second generation strange)
so that the Quantum color force constituent mass Q_{md} of the down quark is

$$Q_{md} = 312.75 + 4.3 = 317.05 \text{ MeV}.$$

Similarly, the up quark Quantum color force mass increase is about
 $(m_c - m_u) (m_u/m_c)^2 a(w) |V_{uc}| = 1777 \times 0.022 \times 0.253 \times 0.22 \text{ MeV} = 2.2 \text{ MeV}$,
(where $|V_{uc}| = 0.22$ is the magnitude
of the K-M parameter mixing first generation up and second generation charm)
so that the Quantum color force constituent mass Q_{mu} of the up quark is

$$Q_{mu} = 312.75 + 2.2 = 314.95 \text{ MeV}.$$

Therefore, the Quantum color force Neutron-Proton mass difference is

$$m_N - m_P = Q_{md} - Q_{mu} = 317.05 \text{ MeV} - 314.95 \text{ MeV} = 2.1 \text{ MeV}.$$

Since the electromagnetic Neutron-Proton mass difference is roughly

$$m_N - m_P = -1 \text{ MeV}$$

the total theoretical Neutron-Proton mass difference is

$$m_N - m_P = 2.1 \text{ MeV} - 1 \text{ MeV} = 1.1 \text{ MeV},$$

an estimate that is comparable to the experimental value of 1.3 MeV.

Pion as Sine-Gordon Breather

The quark content of a charged pion is a quark - antiquark pair: either Up plus antiDown or Down plus antiUp. Experimentally, its mass is about 139.57 MeV.

The quark is a Schwinger Source Kerr-Newman Black Hole with constituent mass M 312 MeV.

The antiquark is also a Schwinger Source Kerr-Newman Black Hole, with constituent mass M 312 MeV.

According to section 3.6 of Jeffrey Winicour's 2001 Living Review of the Development of Numerical Evolution Codes for General Relativity (see also a 2005 update):

"... The black hole event horizon associated with ... slightly broken ... degeneracy [of the axisymmetric configuration]... reveals new features not seen in the degenerate case of the head-on collision ... If the degeneracy is slightly broken, the individual black holes form with spherical topology but as they approach, tidal distortion produces two sharp pincers on each black hole just prior to merger. ...

Tidal distortion of approaching black holes ... Formation of sharp pincers just prior to merger ..

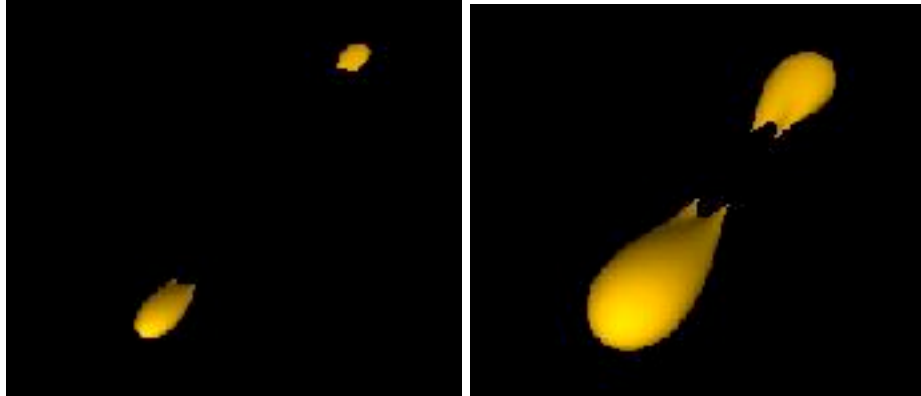

... toroidal stage just after merger ...

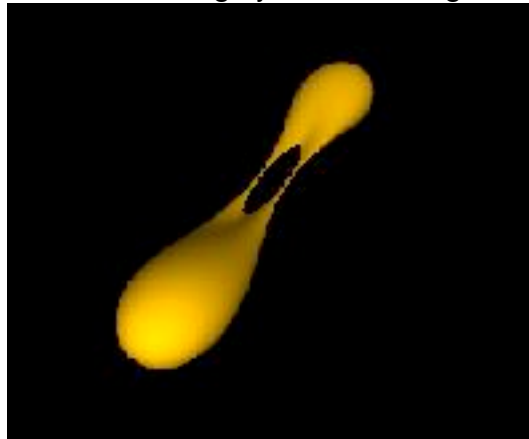

At merger, the two pincers join to form a single ... toroidal black hole.

The inner hole of the torus subsequently [begins to] close... up (superluminally) ... [If the closing proceeds to completion, it]... produce[s] first a peanut shaped black hole and finally a spherical black hole. ...".

In the physical case of quark and antiquark forming a pion, the toroidal black hole remains a torus.

The torus is an event horizon and therefore is not a 2-spacelike dimensional torus, but is a (1+1)-dimensional torus with a timelike dimension.

The effect is described in detail in Robert Wald's book General Relativity (Chicago 1984). It can be said to be due to extreme frame dragging, or to timelike translations becoming spacelike as though they had been Wick rotated in Complex SpaceTime.

As Hawking and Ellis say in The LargeScale Structure of Space-Time (Cambridge 1973):

"... The surface $r = r_+$ is ... the event horizon ... and is a null surface ...

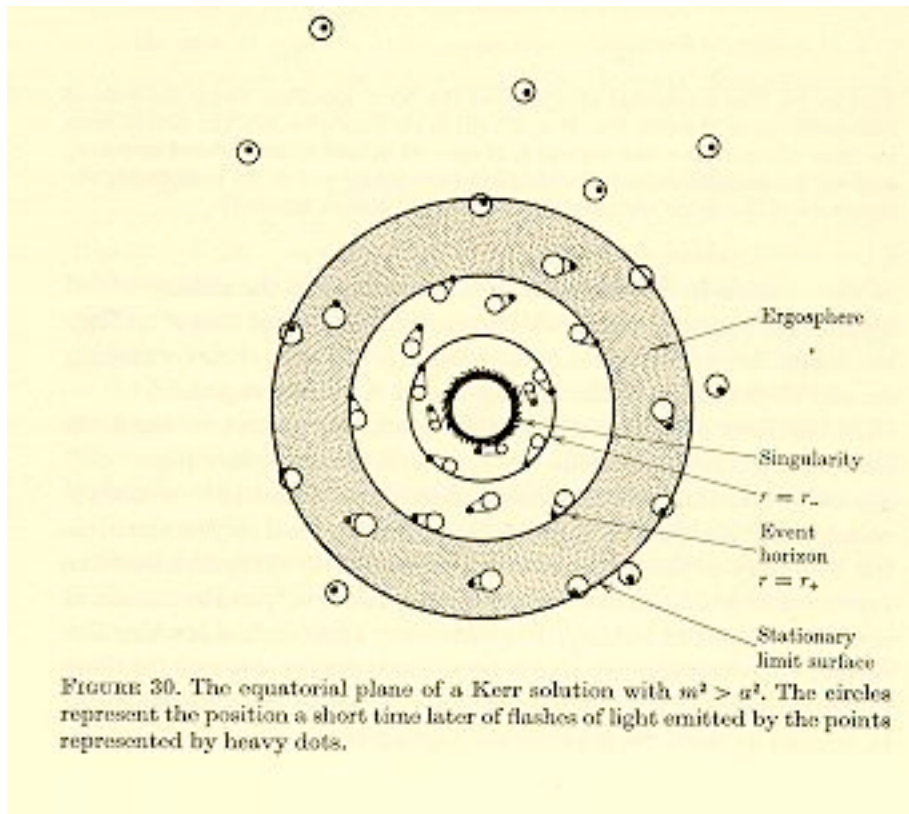

... On the surface $r = r_+$ the wavefront corresponding to a point on this surface lies entirely within the surface. ...".

A (1+1)-dimensional torus with a timelike dimension can carry a Sine-Gordon Breather. The soliton and antisoliton of a Sine-Gordon Breather correspond to the quark and antiquark that make up the pion, analogous to the Massive Thirring Model.

Sine-Gordon Breathers are described by Sidney Coleman in his Erica lecture paper Classical Lumps and their Quantum Descendants (1975), reprinted in his book Aspects of Symmetry (Cambridge 1985), where he writes the Lagrangian for the Sine-Gordon equation as (Coleman's eq. 4.3):

$$L = (1 / B^2) ((1/2) (df)^2 + A (\cos(f) - 1))$$

Coleman says: "... We see that, in classical physics, B is an irrelevant parameter: if we can solve the sine-Gordon equation for any non-zero B, we can solve it for any other B.

The only effect of changing B is the trivial one of changing the energy and momentum assigned to a given solution of the equation. This is not true in quantum physics, because the relevant object for quantum physics is not L but [eq. 4.4]

$$L / \hbar = (1 / (B^2 \hbar)) ((1/2) (df)^2 + A (\cos(f) - 1))$$

An other way of saying the same thing is to say that in quantum physics we have one more dimensional constant of nature, Planck's constant, than in classical physics. ... the classical limit, vanishing \hbar , is exactly the same as the small-coupling limit, vanishing B ... from now on I will ... set \hbar equal to one. ...

... the sine-Gordon equation ... [has] ... an exact periodic solution ... [eq. 4.59] ...

$$f(x, t) = (4 / B) \arctan((n \sin(w t) / \cosh(n w x))$$

where [eq. 4.60] $n = \sqrt{ A - w^2 } / w$ and w ranges from 0 to A.

This solution has a simple physical interpretation ... a soliton far to the left ... [and] ... an antisoliton far to the right. As $\sin(w t)$ increases, the soliton and antisoliton move farther apart from each other. When $\sin(w t)$ passes through one, they turn around and begin to approach one another. As $\sin(w t)$ comes down to zero ... the soliton and antisoliton are on top of each other ... when $\sin(w t)$ becomes negative .. the soliton and antisoliton have passed each other.

... Thus, Eq. (4.59) can be thought of as a soliton and an antisoliton oscillation about their common center-of-mass. For this reason, it is called 'the doublet [or Breather] solution'. ... the energy of the doublet ... [eq. 4.64]

$$E = 2 M \sqrt{ 1 - (w^2 / A) }$$

where [eq. 4.65] $M = 8 \sqrt{ A } / B^2$ is the soliton mass.

Note that the mass of the doublet is always less than twice the soliton mass, as we would expect from a soliton-antisoliton pair. ...

Dashen, Hasslacher, and Neveu ... Phys. Rev. D10, 4114; 4130; 4138 (1974).
 ...[found that]... there is only a single series of bound states, labeled by the integer N ...
 The energies ... are ... [eq. 4.82]

$$E_N = 2 M \sin(B'^2 N / 16)$$

where $N = 0, 1, 2 \dots < 8 \pi / B'^2$, [eq. 4.83]

$B'^2 = B^2 / (1 - (B^2 / 8 \pi))$ and M is the soliton mass.

M is not given by Eq. (4.65), but is the soliton mass corrected by the DHN formula, or, equivalently, by the first-order weak coupling expansion. ...

I have written the equation in this form .. to eliminate A, and thus avoid worries about renormalization conventions.

Note that the DHN formula is identical to the Bohr-Sommerfeld formula, except that B is replaced by B'.

Bohr and Sommerfeld[s] ... quantization formula says that if we have a one-parameter family of periodic motions, labeled by the period, T, then an energy eigenstate occurs whenever [eq. 4.66]

$$[\text{Integral from 0 to T}](dt p \dot{q} = 2 \pi N,$$

where N is an integer. ... Eq.(4.66) is cruder than the WKB formula, but it is much more general;

it is always the leading approximation for any dynamical system ...

Dashen et al speculate that Eq. (4.82) is exact. ...

the sine-Gordon equation is equivalent ... to the massive Thirring model.

This is surprising,

because the massive Thirring model is a canonical field theory

whose Hamiltonian is expressed in terms of fundamental Fermi fields only.

Even more surprising, when $B^2 = 4 \pi$, that sine-Gordon equation is equivalent to a free massive Dirac theory, in one spatial dimension. ...

Furthermore, we can identify the mass term in the Thirring model with the sine-Gordon interaction, [eq. 5.13]

$$M = - (A / B^2) N_m \cos(B f)$$

.. to do this consistently ... we must say [eq. 5.14]

$$B^2 / (4 \pi) = 1 / (1 + g / \pi)$$

....[where]... g is a free parameter, the coupling constant [for the Thirring model]...

Note that if $B^2 = 4 \pi$, $g = 0$,

and the sine-Gordon equation is the theory of a free massive Dirac field. ...

It is a bit surprising to see a fermion appearing as a coherent state of a Bose field.

Certainly this could not happen in three dimensions,

where it would be forbidden by the spin-statistics theorem.

However, there is no spin-statistics theorem in one dimension,

for the excellent reason that there is no spin. ...

the lowest fermion-antifermion bound state of the massive Thirring model

is an obvious candidate for the fundamental meson of sine-Gordon theory. ...

equation (4.82) predicts that

all the doublet bound states disappear when B^2 exceeds 4π .

This is precisely the point where the Thirring model interaction switches from attractive to repulsive. ... these two theories ... the massive Thirring model .. and ... the sine-Gordon equation ... define identical physics. ...

I have computed the predictions of ...[various]... approximation methods for the ration of the soliton mass to the meson mass for three values of B^2 : 4π (where the qualitative picture of the soliton as a lump totally breaks down), 2π , and π . At 4π we know the exact answer ... I happen to know the exact answer for 2π , so I have included this in the table. ...

Method	$B^2 = \pi$	$B^2 = 2\pi$	$B^2 = 4\pi$
Zeroth-order weak coupling expansion eq2.13b	2.55	1.27	0.64
Coherent-state variation	2.55	1.27	0.64
First-order weak coupling expansion	2.23	0.95	0.32
Bohr-Sommerfeld eq4.64	2.56	1.31	0.71
DHN formula eq4.82	2.25	1.00	0.50
Exact	?	1.00	0.50

...[eq. 2.13b]

$$E = 8 \sqrt{A} / B^2$$

...[is the]... energy of the lump ... of sine-Gordon theory ... frequently called 'soliton...' in the literature ...

[Zeroth-order is the classical case, or classical limit.] ...

... Coherent-state variation always gives the same result as the ... Zeroth-order weak coupling expansion The ... First-order weak-coupling expansion ... explicit formula ... is $(8 / B^2) - (1 / \pi)$".

Using the $Cl(1,25)$ E8 model constituent mass of the Up and Down quarks and antiquarks, about 312.75 MeV, as the soliton and antisoliton masses, and setting $B^2 = \pi$ and using the DHN formula, the mass of the charged pion is calculated to be $(312.75 / 2.25)$ MeV = 139 MeV which is close to the experimental value of about 139.57 MeV.

Why is the value $B^2 = \pi$ the special value that gives the pion mass ?

(or, using Coleman's eq. (5.14), the Thirring coupling constant $g = 3\pi$)

Because $B^2 = \pi$ is where the First-order weak coupling expansion substantially coincides with the (probably exact) DHN formula. In other words,

The physical quark - antiquark pion lives where the first-order weak coupling expansion is exact.

Planck Mass as Superposition Fermion Condensate

At a single spacetime vertex, a Planck-mass black hole is the Many-Worlds quantum sum of all possible virtual first-generation particle-antiparticle fermion pairs allowed by the Pauli exclusion principle to live on that vertex.

Once a Planck-mass black hole is formed, it is stable in the E8 model. Less mass would not be gravitationally bound at the vertex. More mass at the vertex would decay by Hawking radiation.

There are 8 fermion particles and 8 fermion antiparticles for a total of 64 particle-antiparticle pairs. Of the 64 particle-antiparticle pairs, 12 are bosonic pions.

A typical combination should have about 6 pions so it should have a mass of about $.14 \times 6 \text{ GeV} = 0.84 \text{ GeV}$.

Just as the pion mass of .14 GeV is less than the sum of the masses of a quark and an antiquark, pairs of oppositely charged pions may form a bound state of less mass than the sum of two pion masses.

If such a bound state of oppositely charged pions has a mass as small as .1 GeV, and if the typical combination has one such pair and 4 other pions, then the typical combination could have a mass in the range of 0.66 GeV.

Summing over all 2^{64} combinations, the total mass of a one-vertex universe should give a Planck mass roughly around $0.66 \times 2^{64} = 1.217 \times 10^{19} \text{ GeV}$.

The value for the Planck mass given in by the 1998 Particle Data Group is $1.221 \times 10^{19} \text{ GeV}$.

Gauge Bosons and Force Strengths

Photon

The Standard Model U(1) Electromagnetic Force bosons (photons) live in a U(1) subalgebra of the U(2) local group of CP2 = SU(3) / U(2). They "see" M4 Physical spacetime as four 1-sphere circles $S^1 \times S^1 \times S^1 \times S^1 = T^4$ ($T^4 = 4$ -torus) each of whose dimension is 1 and has volume 2π .

Their part of the Physical Lagrangian is

$$\int_{T^4} (\text{U(1) Electromagnetism Gauge Boson Term})$$

T4 .
an integral over SpaceTime T4.

Schwinger Source for U(1) photons that carry no charge, so the Complex Bounded Domains and Shilov Boundaries can be set equal to 1 and the Electromagnetic Force Strength is given by the SpaceTime T4 volume.

One fourth of the Electromagnetic Force Strength is given by 2π .

The total Electromagnetic Force Strength relative to the geometric strength of Einstein-Hilbert Gravity is $1/137.03608$.

The force strength is given at the characteristic energy level of the generalized Bohr radius which for U(1) Electromagnetism is about 4KeV.

Weak Boson

The Standard Model SU(2) Weak Force bosons live in a SU(2) subalgebra of the U(2) local group of CP2 = SU(3) / U(2). They "see" M4 Physical spacetime as two 2-spheres S2 x S2 each of whose dimension is 2 and each of whose volume is 4 pi

Their part of the Physical Lagrangian is

$$\int_{S^2 \times S^2} \text{SU(2) Weak Force Gauge Boson Term}$$

an integral over SpaceTime S2 x S2.

Schwinger Source for SU(2) Weak Force bosons is the Complex Bounded Domain is two copies of IV3 Lie Ball each with Symmetric Space Lie Sphere Spin(5) / Spin(3)xU(1) and volume pi^3 / 24 and Shilov Boundary RP1 x S2 with volume 4 pi^2

Due to the action of the Higgs mechanism, for the Weak Force, the effective force strength that we see in our experiments is suppressed by the Weak Boson masses squared (1 / (MW+^2 + MW-^2 + MWO^2)). The unsuppressed Weak Force strength is the Geometric Part of the force strength.

One half of the Geometric Weak Force Strength is given by (4 pi) (4 pi^2) / (pi^3 / 24)^(1 / 2)

(pi^3 / 24)^(1 / 2) = (Vol(IV3))^(1 / 2) is a dimensional normalization factor to reconcile the dimensionality of the Internal Symmetry Space Bounded Domain with the dimensionality of Spacetime Lagrangian Base Manifold.

The geometric force strength, relative to the geometric strength of Einstein-Hilbert Gravity, of the Weak Force is 0.2535

The total force strength of the SU(2) Weak Force, including the suppression factor of the Weak Boson masses squared, is given by $G_w \times M_{\text{proton}}^2 = \text{about } 1.05 \times 10^{-5}$

Note that MWO is the mass of the SU(2) WO Weak boson that combines with the U(1) boson by the Higgs mechanism to form the Zo Weak boson and the Photon. MWO is about 98 GeV, MW+ = MW- is about 80 GeV, MZo is about 92 GeV, and the Photon is massless.

Gluon

The Standard Model SU(3) Color Force bosons (gluons) live in a SU(3) subalgebra of the SU(4) subalgebra of D4 = Spin(8). They "see" M4 Physical spacetime as the complex projective plane CP2 whose dimension is 4 and whose volume is $8 \pi^2 / 3$

Their part of the Physical Lagrangian is

\int_{CP2} SU(3) Color Force Gauge Boson Term
an integral over SpaceTime CP2.

Schwinger Source for SU(3) Color Force bosons (gluons) is the Complex Bounded Domain B6 (ball) with Symmetric Space SU(4) / SU(3)xU(1) and volume $\pi^3 / 6$ and Shilov Boundary S5 with volume $4 \pi^3$

The Color Force Strength is given by
(Vol(CP2)) (Vol(S5) / Vol(B6)^(1 / 4))

Vol(B6)^(1 / 4) is a dimensional normalization factor to reconcile the dimensionality of the Internal Symmetry Space Bounded Domain with the dimensionality of Spacetime Lagrangian Base Manifold.

The force strength, relative to the geometric strength of Einstein-Hilbert Gravity, of the SU(3) Color Force is 0.6286 at the characteristic energy level of the Color Force (about 245 MeV).

The color force strength was calculated using a simple perturbative QCD renormalization group equation at various energies, with the following results:
Energy Level Color Force Strength

245 MeV	0.6286
5.3 GeV	0.166
34 GeV	0.121
91 GeV	0.106

Taking other effects, such as Nonperturbative QCD, into account, should give a Color Force Strength of about 0.125 at about 91 GeV

Note (thanks to Carlos Castro for noticing these) that the volume listed for S5 is for a squashed S5, a Shilov boundary of the complex domain corresponding to the symmetric space SU(4) / SU(3) x U(1) and also that the volume listed for CP2 is unconventional, but physically justified by noting that S4 and CP2 can be seen as having the same physical volume, with the only difference being structure at infinity.

Conformal Graviton

The Gravity Gauge Bosons (Schwinger-Euclidean versions) live in a Spin(5) subalgebra of the Spin(6) Conformal subalgebra of $D_4 = Spin(8)$. They "see" M4 Physical spacetime as the 4-sphere S^4 whose dimension is 4 and whose volume is $8 \pi^2 / 3$

Their part of the Physical Lagrangian is

\int_{S^4} Gravity Gauge Boson Term
 S^4 .
 an integral over SpaceTime S^4 .

Schwinger Source for Spin(5) MacDowell-Mansouri Gravity bosons is the Complex Bounded Domain IV5 Lie Ball with Symmetric Space Lie Sphere Spin(7) / Spin(5)xU(1) and volume $\pi^5 / 2^4 5!$ and Shilov Boundary $RP^1 \times S^4$ with volume $8 \pi^3 / 3$

Due to Stabilization of Condensate SpaceTime by virtual Planck Mass Gravitational Black Holes, the effective force strength of Gravity that we see in our experiments is suppressed by the square of the Planck Mass ($1 / M_{\text{planck}}^2$). The unsuppressed Gravity force strength is the Geometric Part of the force strength.

The Geometric Einstein-Hilbert Gravity Strength is given by
 ($\text{Vol}(S^4)$) ($\text{Vol}(IV5) / \text{Vol}(RP^1 \times S^4)^{1/4}$)

$\text{Vol}(RP^1 \times S^4)^{1/4}$ is a dimensional normalization factor to reconcile the dimensionality of the Internal Symmetry Space Bounded Domain with the dimensionality of Spacetime Lagrangian Base Manifold.

The geometric force strength, relative to the geometric strength of Einstein-Hilbert Gravity, of Spin(5) MacDowell-Mansouri Gravity is obviously 1.

The total force strength G_{grav} of Spin(5) MacDowell-Mansouri Gravity, including the Planck Mass squared suppression factor, is given by
 $G_{\text{grav}} \times M_{\text{proton}}^2 = \text{about } 5 \times 10^{(-39)}$

Here are more detailed force strength calculations:

The force strength of a given force is

$$\text{alphaforce} = (1 / \text{Mforce}^2) (\text{Vol}(\text{MISforce})) (\text{Vol}(\text{Qforce}) / \text{Vol}(\text{Dforce})^{(1 / \text{mforce})})$$

where:

alphaforce represents the force strength;

Mforce represents the effective mass;

MISforce represents the relevant part of the target Internal Symmetry Space;

Vol(MISforce) stands for volume of MISforce and is sometimes also denoted by Vol(M);

Qforce represents the link from the origin to the relevant target for the gauge boson;

Vol(Qforce) stands for volume of Qforce;

Dforce represents the complex bounded homogeneous domain of which Qforce is the Shilov boundary;

mforce is the dimensionality of Qforce, which is

4 for Gravity and the Color force,

2 for the Weak force (which therefore is considered to have two copies of QW for SpaceTime),

1 for Electromagnetism (which therefore is considered to have four copies of QE for SpaceTime)

$\text{Vol}(\text{Dforce})^{(1 / \text{mforce})}$ stands for a dimensional normalization factor (to reconcile the dimensionality of the Internal Symmetry Space of the target vertex with the dimensionality of the link from the origin to the target vertex).

The Qforce, Hermitian symmetric space, and Dforce manifolds for the four forces are:

Spin(5)	Spin(7) / Spin(5)xU(1)	IV5	4	RP ¹ xS ⁴
SU(3)	SU(4) / SU(3)xU(1)	B ⁶ (ball)	4	S ⁵
SU(2)	Spin(5) / SU(2)xU(1)	IV3	2	RP ¹ xS ²
U(1)	-	-	1	-

The geometric volumes needed for the calculations are mostly taken from the book Harmonic Analysis of Functions of Several Complex Variables in the Classical Domains (AMS 1963, Moskva 1959, Science Press Peking 1958) by L. K. Hua [unit radius scale].

Force	M	Vol(M)
gravity	S^4	$8\pi^2/3$ - S^4 is 4-dimensional
color	CP^2	$8\pi^2/3$ - CP^2 is 4-dimensional
weak	$S^2 \times S^2$	$2 \times 4\pi$ - S^2 is a 2-dim boundary of 3-dim ball 4-dim $S^2 \times S^2$ = topological boundary of 6-dim 2-polyball Shilov Boundary of 6-dim 2-polyball = $S^2 + S^2$ = = 2-dim surface frame of 4-dim $S^2 \times S^2$
e-mag	T^4	$4 \times 2\pi$ - S^1 is 1-dim boundary of 2-dim disk 4-dim $T^4 = S^1 \times S^1 \times S^1 \times S^1$ = topological boundary of 8-dim 4-polydisk Shilov Boundary of 8-dim 4-polydisk = $S^1 + S^1 + S^1 + S^1$ = = 1-dim wire frame of 4-dim T^4

Note (thanks to Carlos Castro for noticing this) also that the volume listed for CP^2 is unconventional, but physically justified by noting that S^4 and CP^2 can be seen as having the same physical volume, with the only difference being structure at infinity.

Note that for U(1) electromagnetism, whose photon carries no charge, the factors Vol(Q) and Vol(D) do not apply and are set equal to 1, and from another point of view, the link manifold to the target vertex is trivial for the abelian neutral U(1) photons of Electromagnetism, so we take QE and DE to be equal to unity.

Force	M	Vol(M)	Q	Vol(Q)	D	Vol(D)
gravity	S^4	$8\pi^2/3$	$RP^1 \times S^4$	$8\pi^3/3$	IV_5	$\pi^5/2^4 5!$
color	CP^2	$8\pi^2/3$	S^5	$4\pi^3$	$B^6(\text{ball})$	$\pi^3/6$
Weak	$S^2 \times S^2$	$2 \times 4\pi$	$RP^1 \times S^2$	$4\pi^2$	IV_3	$\pi^3/24$
e-mag	T^4	$4 \times 2\pi$	-	-	-	-

Note (thanks to Carlos Castro for noticing this) that the volume listed for S^5 is for a squashed S^5 , a Shilov boundary of the complex domain corresponding to the symmetric space $SU(4) / SU(3) \times U(1)$.

Using the above numbers, the results of the calculations are the relative force strengths at the characteristic energy level of the generalized Bohr radius of each force:

Spin(5)	gravity	approx 10^{19} GeV	1	$G G m_{\text{proton}}^2$	approx 5×10^{-39}
SU(3)	color	approx 245 MeV	0.6286		0.6286
SU(2)	weak	approx 100 GeV	0.2535	$G W m_{\text{proton}}^2$	approx 1.05×10^{-5}
U(1)	e-mag	approx 4 KeV	1/137.03608		1/137.03608

The force strengths are given at the characteristic energy levels of their forces, because the force strengths run with changing energy levels.

The effect is particularly pronounced with the color force.

The color force strength was calculated using a simple perturbative QCD renormalization group equation at various energies, with the following results:

Energy Level	Color Force Strength
245 MeV	0.6286
5.3 GeV	0.166
34 GeV	0.121
91 GeV	0.106

Taking other effects, such as Nonperturbative QCD, into account, should give a Color Force Strength of about 0.125 at about 91 GeV

Higgs: W+, W-, Z0 and NJL Truth Quark-AntiQuark

As with forces strengths, the calculations produce ratios of masses, so that only one mass need be chosen to set the mass scale.

In the Cl(16) Cl(1,25) E8 model, the value of the fundamental mass scale vacuum expectation value $v = \langle \text{PHI} \rangle$ of the Higgs scalar field is set to be the sum of the physical masses of the weak bosons, W+, W-, and Z0, whose tree-level masses will then be shown by ratio calculations to be 80.326 GeV, 80.326 GeV, and 91.862 GeV, respectively, and therefore the electron mass will be 0.5110 MeV.

The relationship between the Higgs mass and v is given by the Ginzburg-Landau term from the Mayer Mechanism as

$$(1/4) \text{Tr} ([\text{PHI} , \text{PHI}] - \text{PHI})^2$$

or, i

n the notation of quant-ph/9806009 by Guang-jiong Ni

$$(1/4!) \lambda \text{PHI}^4 - (1/2) \sigma \text{PHI}^2$$

where the Higgs mass $M_H = \sqrt{2 \sigma}$

Ni says:

"... the invariant meaning of the constant λ in the Lagrangian is not the coupling constant, the latter will change after quantization ... The invariant meaning of λ is nothing but the ratio of two mass scales:

$$\lambda = 3 (M_H / \text{PHI})^2$$

which remains unchanged irrespective of the order ...".

Since $\langle \text{PHI} \rangle^2 = v^2$, and assuming that $\lambda = (\cos(\pi / 6))^2 = 0.866^2$ (a value consistent with the Higgs-Tquark condensate model of Michio Hashimoto, Masaharu Tanabashi, and Koichi Yamawaki in their paper at hep-ph/0311165) we have

$$M_H^2 / v^2 = (\cos(\pi / 6))^2 / 3$$

In the Cl(16) Cl(1,25) E8 model, the fundamental mass scale vacuum expectation value v of the Higgs scalar field is the fundamental mass parameter that is to be set to define all other masses by the mass ratio formulas of the model and v is set to be 252.514 GeV so that

$$M_H = v \cos(\pi / 6) / \sqrt{1 / 3} = 126.257 \text{ GeV}$$

This is the value of the Low Mass State of the Higgs observed by the LHC. Middle and High Mass States come from a Higgs-Tquark Condensate System. The Middle and High Mass States may have been observed by the LHC at 20% of the Low Mass State cross section, and that may be confirmed by the LHC 2015-1016 run.

A Non-Condensate Higgs is represented by a Higgs at a point in M4 that is connected to a Higgs representation in CP2 ISS by a line whose length represents the Higgs mass

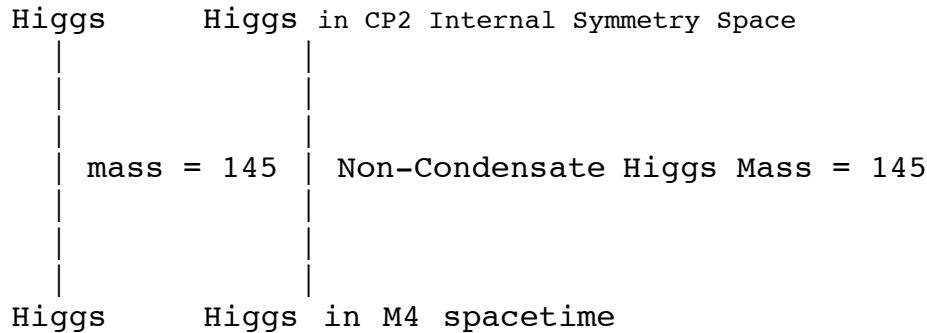

and the value of lambda is $1 = 1^2$
 so that the Higgs mass would be $M_H = v / \sqrt{3} = 145.789 \text{ GeV}$

However, in the $Cl(1,25) E8$ model, the Higgs has structure of a Tquark condensate

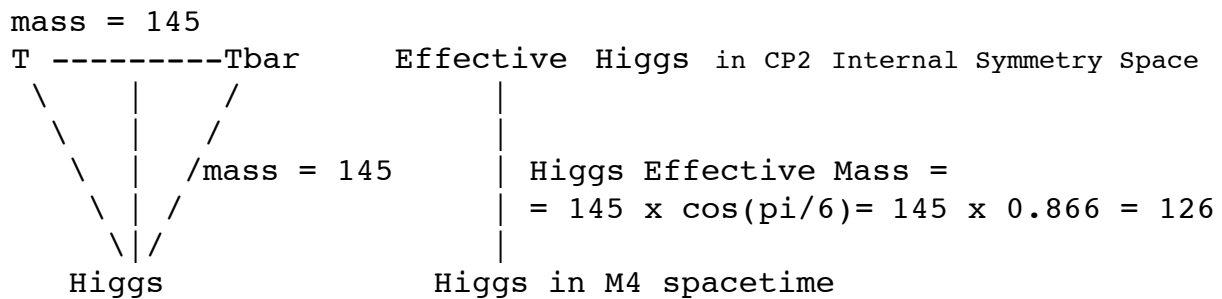

in which the Higgs at a point in M4 is connected to a T and Tbar in CP2 ISS so that the vertices of the Higgs-T-Tbar system are connected by lines forming an equilateral triangle composed of 2 right triangles (one from the CP2 origin to the T and to the M4 Higgs and another from the CP2 origin to the Tbar and to the M4 Higgs).

In the T-quark condensate picture
 $\lambda = 1^2 = \lambda(T) + \lambda(H) = (\sin(\pi / 6))^2 + (\cos(\pi / 6))^2$
 and
 $\lambda(H) = (\cos(\pi / 6))^2$

Therefore the Effective Higgs mass observed by LHC is:

$$\text{Higgs Mass} = 145.789 \times \cos(\pi/6) = 126.257 \text{ GeV.}$$

To get W-boson masses,
 denote the 3 SU(2) high-energy weak bosons
 (massless at energies higher than the electroweak unification)
 by W_+ , W_- , and W_0 ,
 corresponding to the massive physical weak bosons W_+ , W_- , and Z_0 .

The triplet $\{ W_+, W_-, W_0 \}$ couples directly with the T - Tbar quark-antiquark pair,
 so that the total mass of the triplet $\{ W_+, W_-, W_0 \}$ at the electroweak unification
 is equal to the total mass of a T - Tbar pair, 259.031 GeV.

The triplet $\{ W_+, W_-, Z_0 \}$ couples directly with the Higgs scalar,
 which carries the Higgs mechanism by which the W_0 becomes the physical Z_0 ,
 so that the total mass of the triplet $\{ W_+, W_-, Z_0 \}$
 is equal to the vacuum expectation value v of the Higgs scalar field, $v = 252.514$ GeV.

What are individual masses of members of the triplet $\{ W_+, W_-, Z_0 \}$?

First, look at the triplet $\{ W_+, W_-, W_0 \}$ which can be represented by the 3-sphere S^3 .
 The Hopf fibration of S^3 as

$$S^1 \rightarrow S^3 \rightarrow S^2$$

gives a decomposition of the W bosons into the neutral W_0 corresponding to S^1
 and the charged pair W_+ and W_- corresponding to S^2 .

The mass ratio of the sum of the masses of W_+ and W_- to the mass of W_0
 should be the volume ratio of the S^2 in S^3 to the S^1 in S^3 .

The unit sphere S^3 in R^4 is normalized by $1/2$.

The unit sphere S^2 in R^3 is normalized by $1/\sqrt{3}$.

The unit sphere S^1 in R^2 is normalized by $1/\sqrt{2}$.

The ratio of the sum of the W_+ and W_- masses to the W_0 mass should then be
 $(2/\sqrt{3}) V(S^2) / (2/\sqrt{2}) V(S^1) = 1.632993$

Since the total mass of the triplet $\{ W_+, W_-, W_0 \}$ is 259.031 GeV,
 the total mass of a T - Tbar pair, and the charged weak bosons have equal mass,
 we have

$$M_{W_+} = M_{W_-} = 80.326 \text{ GeV and } M_{W_0} = 98.379 \text{ GeV.}$$

The charged W_{\pm} neutrino-electron interchange must be symmetric
 with the electron-neutrino interchange, so that the tree-level absence
 of right-handed neutrino particles requires that

the charged W_{\pm} SU(2) weak bosons act only on left-handed electrons.

Each gauge boson must act consistently on the entire Dirac fermion particle sector,
 so that the
 charged W_{\pm} SU(2) weak bosons act only on left-handed fermion particles of all types.

The neutral W_0 weak boson does not interchange Weyl neutrinos with Dirac fermions, and so is not restricted to left-handed fermions, but also has a component that acts on both types of fermions, both left-handed and right-handed, conserving parity.

However, the neutral W_0 weak bosons are related to the charged $W_{+/-}$ weak bosons by custodial $SU(2)$ symmetry, so that the left-handed component of the neutral W_0 must be equal to the left-handed (entire) component of the charged $W_{+/-}$.

Since the mass of the W_0 is greater than the mass of the $W_{+/-}$, there remains for the W_0 a component acting on both types of fermions.

Therefore the full W_0 neutral weak boson interaction is proportional to $(M_{W_{+/-}}^2 / M_{W_0}^2)$ acting on left-handed fermions and $(1 - (M_{W_{+/-}}^2 / M_{W_0}^2))$ acting on both types of fermions.

If $(1 - (M_{W_{+/-}}^2 / M_{W_0}^2))$ is defined to be $\sin(\theta_w)^2$ and denoted by K , and if the strength of the $W_{+/-}$ charged weak force (and of the custodial $SU(2)$ symmetry) is denoted by T , then the W_0 neutral weak interaction can be written as $W_0L = T + K$ and $W_0LR = K$.

Since the W_0 acts as W_0L with respect to the parity violating $SU(2)$ weak force and as W_0LR with respect to the parity conserving $U(1)$ electromagnetic force, the W_0 mass m_{W_0} has two components: the parity violating $SU(2)$ part m_{W_0L} that is equal to $M_{W_{+/-}}$ and the parity conserving part M_{W_0LR} that acts like a heavy photon.

As $M_{W_0} = 98.379 \text{ GeV} = M_{W_0L} + M_{W_0LR}$, and as $M_{W_0L} = M_{W_{+/-}} = 80.326 \text{ GeV}$, we have $M_{W_0LR} = 18.053 \text{ GeV}$.

Denote by $\alpha_E = e^2$ the force strength of the weak parity conserving $U(1)$ electromagnetic type force that acts through the $U(1)$ subgroup of $SU(2)$.

The electromagnetic force strength $\alpha_E = e^2 = 1 / 137.03608$ was calculated above using the volume $V(S^1)$ of an S^1 in R^2 , normalized by $1 / \sqrt{2}$.

The α_E force is part of the $SU(2)$ weak force whose strength $\alpha_W = w^2$ was calculated above using the volume $V(S^2)$ of an $S^2 \subset R^3$, normalized by $1 / \sqrt{3}$.

Also, the electromagnetic force strength $\alpha_E = e^2$ was calculated above using a 4-dimensional spacetime with global structure of the 4-torus T^4 made up of four S^1 1-spheres, while the $SU(2)$ weak force strength $\alpha_W = w^2$ was calculated above using two 2-spheres $S^2 \times S^2$, each of which contains one 1-sphere of the α_E force.

Therefore

$$\begin{aligned} *alphaE &= alphaE (\sqrt{ 2 } / \sqrt{ 3 })(2 / 4) = alphaE / \sqrt{ 6 } , \\ *e &= e / (4th \text{ root of } 6) = e / 1.565 , \end{aligned}$$

and

the mass mW0LR must be reduced to an effective value

$$M_W0LReff = M_W0LR / 1.565 = 18.053/1.565 = 11.536 \text{ GeV}$$

for the *alphaE force to act like an electromagnetic force in the E8 model:

$$*e M_W0LR = e (1/5.65) M_W0LR = e M_Z0,$$

where the physical effective neutral weak boson is denoted by Z0.

Therefore, the correct Cl(1,25) E8 model values for weak boson masses and the Weinberg angle theta_w are:

$$M_W+ = M_W- = 80.326 \text{ GeV};$$

$$M_Z0 = 80.326 + 11.536 = 91.862 \text{ GeV};$$

$$\text{Sin}(\text{theta}_w)^2 = 1 - (M_W+/- / M_Z0)^2 = 1 - (6452.2663 / 8438.6270) = 0.235.$$

Radiative corrections are not taken into account here, and may change these tree-level values somewhat.

The Higgs and a Tquark-Tanti-quark Nambu-Jona-Lasinio condensate

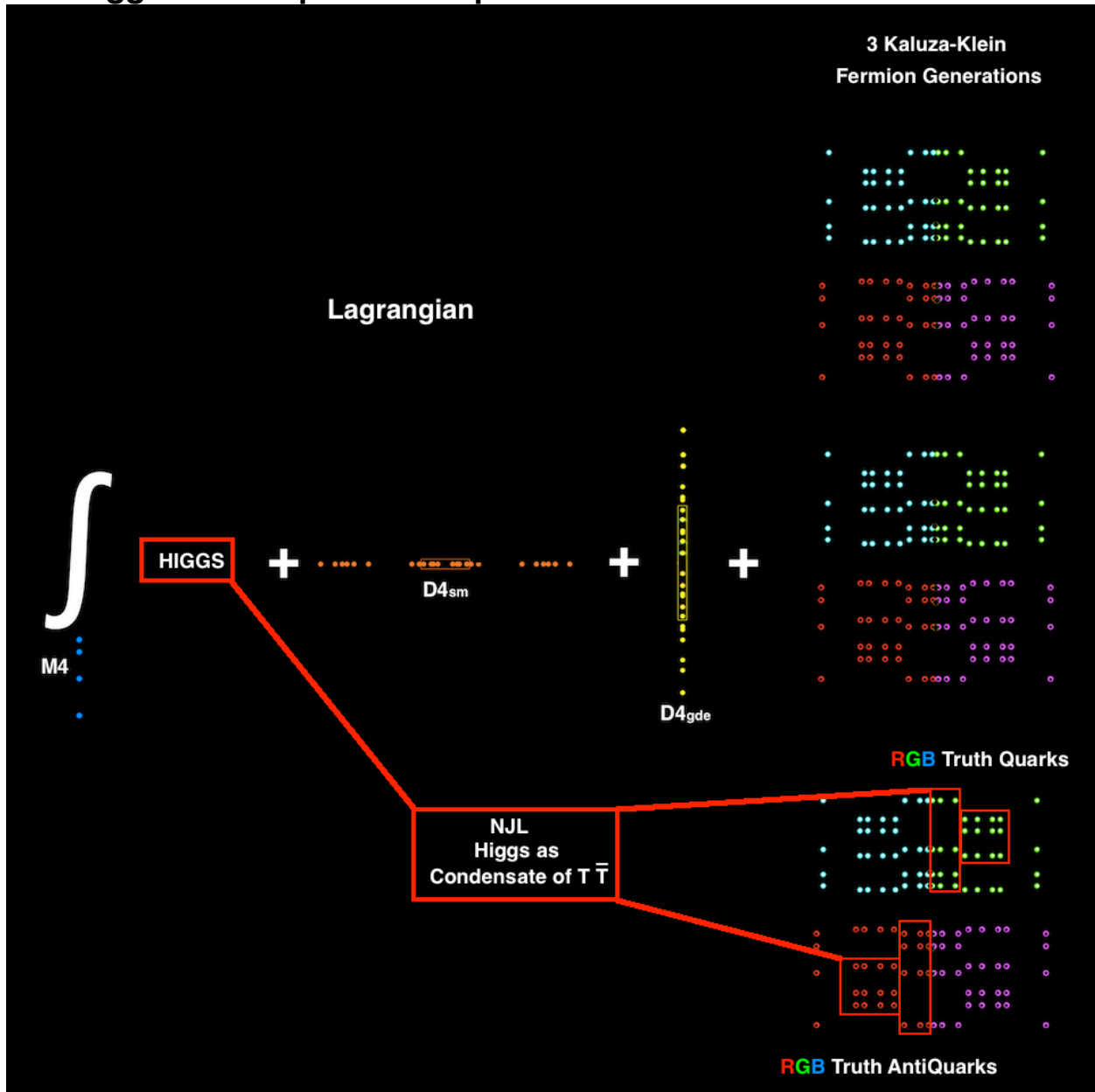

form a Higgs-Tquark NJL-type system with 3 Mass States

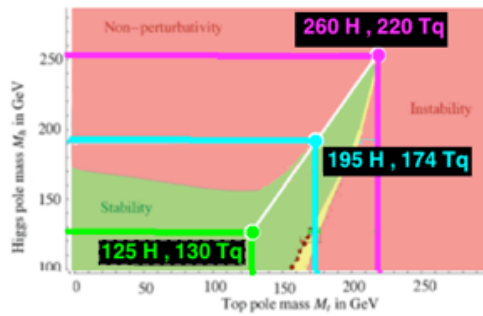

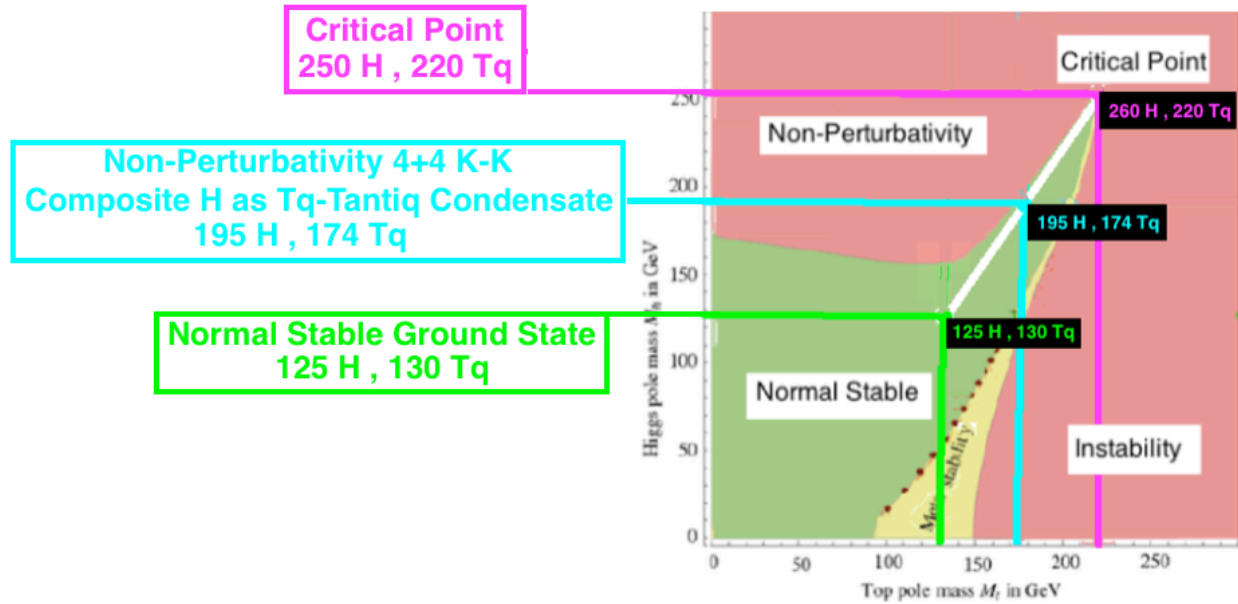

The Green Dot where the White Line originates in our Ordinary Phase is the **Low-mass state of a 130 GeV Truth Quark and a 125 GeV Higgs.**

The 130 GeV Tquark mass is also predicted by Connes's NCG (NonCommutative Geometry) by the formula $M_t = \sqrt{8/3} M_w$

The Cyan Dot where the White Line hits the Triviality Boundary leaving the Ordinary Phase is the **Middle-mass state of a 174 GeV Truth Quark and Higgs around 200 GeV.** It corresponds to the Higgs mass calculated by Hashimoto, Tanabashi, and Yamawaki in hep-ph/0311165 where they say:

"... We perform the most attractive channel (MAC) analysis in the top mode standard model with TeV-scale extra dimensions, where the standard model gauge bosons and the third generation of quarks and leptons are put in $D(=6,8,10,\dots)$ dimensions. In such a model, bulk gauge couplings rapidly grow in the ultraviolet region. In order to make the scenario viable, only the attractive force of the top condensate should exceed the critical coupling, while other channels such as the bottom and tau condensates should not. We then find that the top condensate can be the MAC for $D=8$... We predict masses of the top (m_t) and the Higgs (m_H) ... based on the renormalization group for the top Yukawa and Higgs quartic couplings with the compositeness conditions at the scale where the bulk top condenses ... for ... [Kaluza-Klein type] ... dimension... $D=8$... $m_t = 172-175$ GeV and $m_H=176-188$ GeV ...".

As to composite Higgs and the Triviality boundary, Pierre Ramond says in his book *Journeys Beyond the Standard Model* (Perseus Books 1999) at pages 175-176: "... The Higgs quartic coupling has a complicated scale dependence. It evolves according to $d\lambda/dt = (1/16\pi^2)\beta_\lambda$ where the one loop contribution is given by $\beta_\lambda = 12\lambda^2 - \dots - 4H^2$... The value of λ at low energies is related [to] the physical value of the Higgs mass according to the tree level formula $m_H = v\sqrt{2\lambda}$ while the vacuum value is determined by the Fermi constant ... for a fixed vacuum value v , let us assume that the Higgs mass and therefore λ is large. In that case, β_λ is dominated by the λ^2 term, which drives the coupling towards its Landau pole at higher energies. Hence the higher the Higgs mass, the higher λ is and the closer the Landau pole to experimentally accessible regions. This means that for a given (large) Higgs mass, we expect the standard model to enter a strong coupling regime at relatively low energies, losing in the process our ability to calculate. This does not necessarily mean that the theory is incomplete, only that we can no longer handle it ... it is natural to think that this effect is caused by new strong interactions, and that the Higgs actually is a composite ... The resulting bound on λ is sometimes called the triviality bound. The reason for this unfortunate name (the theory is anything but trivial) stems from lattice studies where the coupling is assumed to be finite everywhere; in that case the coupling is driven to zero, yielding in fact a trivial theory. In the standard model λ is certainly not zero. ...".

The Magenta Dot  at the end of the White Line is the **High-mass state of a 220 GeV Truth Quark and a 240 GeV Higgs**. It is at the critical point of the Higgs-Tquark System with respect to Vacuum Instability and Triviality. It corresponds to the description in hep-ph/9603293 by Koichi Yamawaki of the Bardeen-Hill-Lindner model: "... the BHL formulation of the top quark condensate ... is based on the RG equation combined with the compositeness condition ... start[s] with the SM Lagrangian which includes explicit Higgs field at the Lagrangian level ... BHL is crucially based on the perturbative picture ...[which]... breaks down at high energy near the compositeness scale $\Lambda \dots [10^{19} \text{ GeV}]$... there must be a certain matching scale $\Lambda_{\text{Matching}}$ such that the perturbative picture (BHL) is valid for $\mu < \Lambda_{\text{Matching}}$, while only the nonperturbative picture (MTY) becomes consistent for $\mu > \Lambda_{\text{Matching}}$... However, thanks to the presence of a quasi-infrared fixed point, BHL prediction is numerically quite stable against ambiguity at high energy region, namely, rather independent of whether this high energy region is replaced by MTY or something else. ... Then we expect $m_t = m_t(\text{BHL}) = \dots = 1/(\sqrt{2}) y_{\text{bar}} v$ within 1-2%, where y_{bar} is the quasi-infrared fixed point given by $\text{Beta}(y_{\text{bar}}) = 0$ in ... the one-loop RG equation ... The composite Higgs loop changes y_{bar}^2 by roughly the factor $N_c/(N_c + 3/2) = 2/3$ compared with the MTY value, i.e., $250 \text{ GeV} \rightarrow 250 \times \sqrt{2/3} = 204 \text{ GeV}$, while the electroweak gauge boson loop with opposite sign pulls it back a little bit to a higher value. The **BHL value is then given by $m_t = 218 \pm 3 \text{ GeV}$** , at $\Lambda = 10^{19} \text{ GeV}$.

The Higgs boson was predicted as a $t\bar{t}$ bound state with a mass $M_H = 2m_t$ based on the pure NJL model calculation. Its mass was also calculated by BHL through the full RG equation ... the result being ... $M_H / m_t = 1.1$) at $\Lambda = 10^{19}$ GeV ...

[$1.1 \times 218 = 239.8$ GeV for M_H with $m_t = 218$]

... the top quark condensate proposed by Miransky, Tanabashi and Yamawaki (MTY) and by Nambu independently ... entirely replaces the standard Higgs doublet by a composite one formed by a strongly coupled short range dynamics (four-fermion interaction) which triggers the top quark condensate. The Higgs boson emerges as a $t\bar{t}$ bound state and hence is deeply connected with the top quark itself. ... MTY introduced explicit four-fermion interactions responsible for the top quark condensate in addition to the standard gauge couplings. Based on the explicit solution of the ladder SD equation, MTY found that even if all the dimensionless four-fermion couplings are of $O(1)$, only the coupling larger than the critical coupling yields non-zero (large) mass ... The model was further formulated in an elegant fashion by Bardeen, Hill and Lindner (BHL) in the SM language, based on the RG equation and the compositeness condition. BHL essentially incorporates $1/N_c$ sub-leading effects such as those of the composite Higgs loops and ... gauge boson loops which were disregarded by the MTY formulation. We can explicitly see that BHL is in fact equivalent to MTY at $1/N_c$ -leading order. Such effects turned out to reduce the above MTY value 250 GeV down to 220 GeV ...".

On 4 June 2018 at LHCP Bologna 2018 Roberto Carlin presented "Status and highlights from the CMS experiment".

His Slide 14 referred to CMS-PAS-HIG-18-001 dated 3 June 2018 which says "... The $H \rightarrow ZZ \rightarrow 4l$ decay channel ($l = e, \mu$) has a large signal-to-background ratio due to the complete reconstruction of the final state decay products and excellent lepton momentum resolution ...

A data sample of proton-proton collisions at a center-of-mass energy of 13 TeV is used, corresponding to an integrated luminosity of **41.5 fb⁻¹ recorded in 2017** by the CMS detector at the LHC. ... Figure 2 ... Distribution of the four-lepton reconstructed invariant mass m_{4l} in the full mass range ...

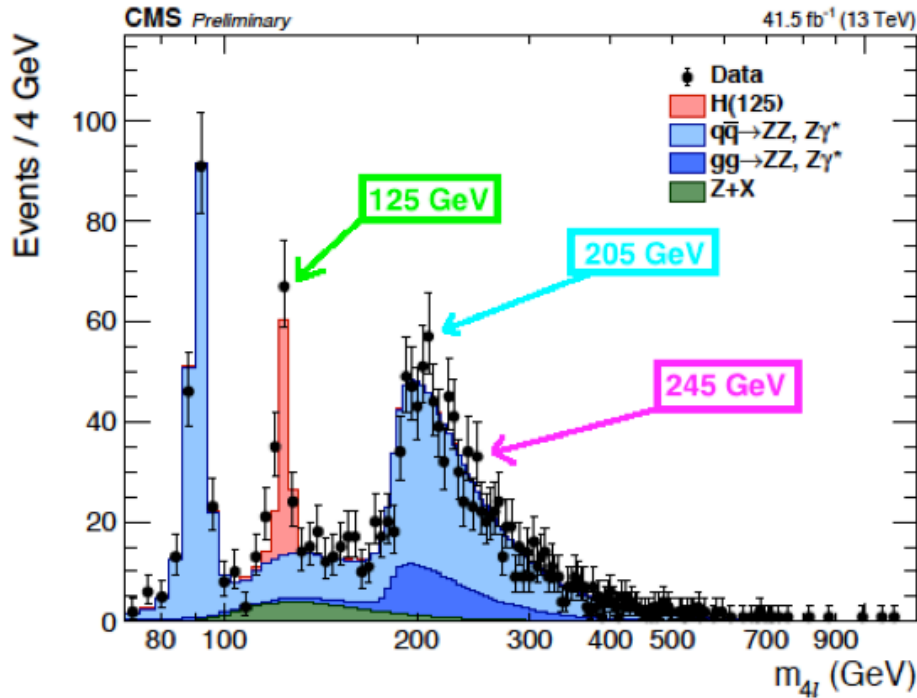

The 41.5 fb⁻¹ 2017 CMS histogram is very similar to its 35.9 fb⁻¹ 2016 counterpart from CMS PAS HIG-17-012 (2017/12/08) Figure 2:

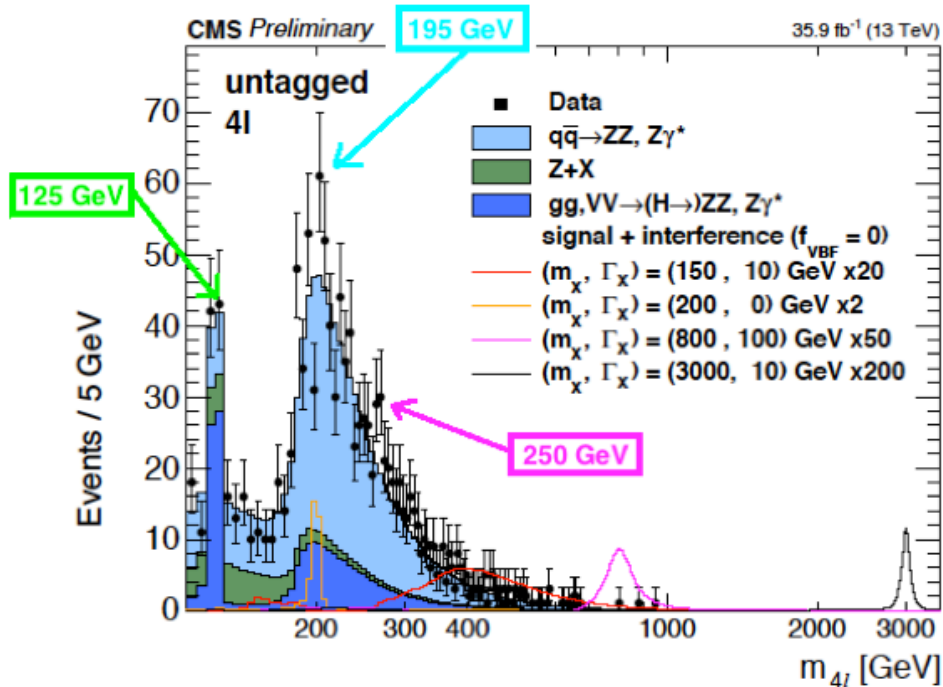

CMS PAS HIG-18-001 (2018/06/03) also says “... Combination [of 2017 data] with data recorded in 2016 by ... CMS ... 13 TeV corresponding to an integrated luminosity of 35.9 fb⁻¹ is reported ...” and is shown in the top image on the next page.

CMS used bin size 5 GeV for its 2016 data and 4 GeV for its 2017 data and for the combined 2016 + 2017 histogram (top image on next page). Tommaso Dorigo on 16 May 2011 put on his blog a post titled “Choose Bins Wisely” saying “... The only concern with too

narrow bins is ...that random fluctuations might distract the user's attention from the important features of the distribution ... Let us see ... typical experimental cases ... [Case three]... Barely significant bump, small statistics ... Here I believe the narrowest binning is a bit extreme ...". Lubos Motl commented "... the main trade-off here is clear. If the bins are too wide, you lose the detailed information about the x-coordinate.

If the bins are too narrow, you lose the information about the y-coordinates -
the number of events / objects in each bin becomes too fluctuating ...
It's always possible to merge bins into bigger ones ..."

In the CMS combined histogram it seems to me that there are some large fluctuations between adjacent bins so to smooth out that noise I **merged some adjacent 4 GeV bins to get 8 GeV bins** in the combined histogram

The results of **merging some 4 GeV Bins to 8 GeV Bins** are shown in the histogram at the next page. Merged 8 GeV bins are colored **red** or **cyan** or **magenta**.

All three Higgs mass states show up more clearly using larger merged bins although the underlying data are the same.

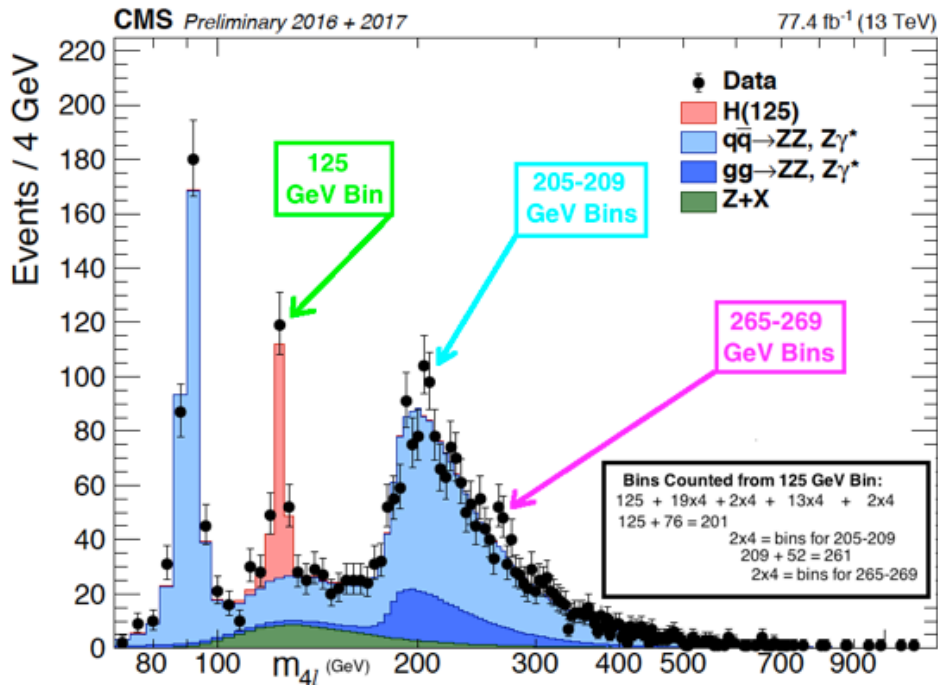

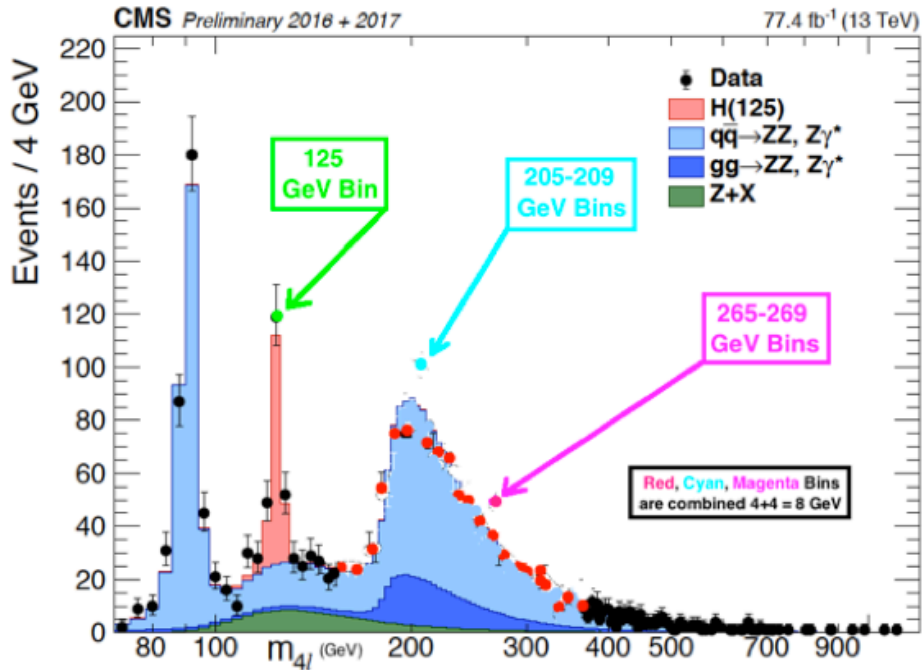

The LHCP Bologna 2018 presentation “Searches for BSM Higgs Bosons ...” by Mariarosaria D’Alfonso did not contain anything relevant to Higgs \rightarrow ZZ \rightarrow 4l more recent than the histogram of Slide 14 based on 2016 data in arXiv 1804.01939

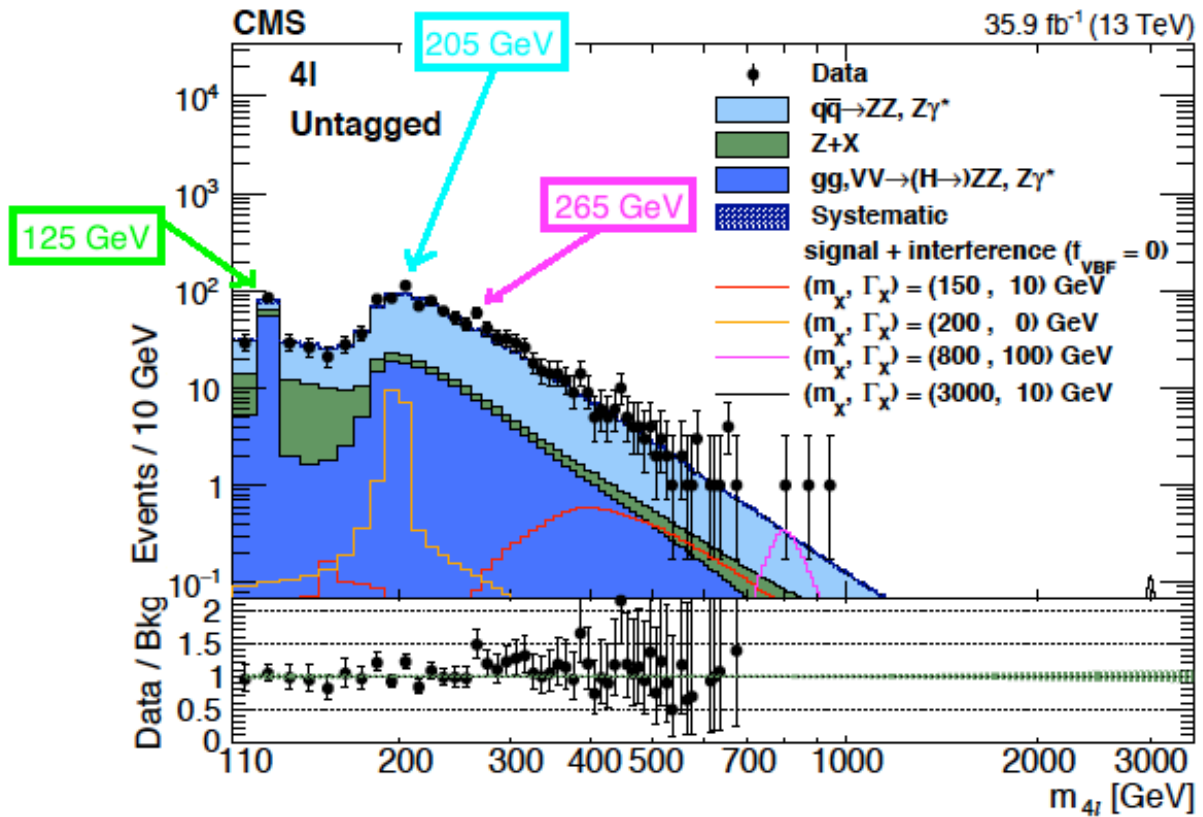

Although all three Higgs mass states are shown in the histogram,

and its 10 GeV Bin width gives a smoother background than 4 GeV or 5 GeV Bin width, the use by CMS of a log scale for event number makes the states less obvious than they seem in histograms with a linear scale for event number.

Despite the clarity of the presence of all three Higgs mass states, Slide 26 says

“... BSM Higgs bosons are still hiding ...”

so the official LHC opinion is that the excess peaks around 200 GeV and 250 GeV are nothing but statistical fluctuations, which opinion may be at least in part based on using a LEE (Look Elsewhere Effect) for the histogram range 110 GeV to 3000 GeV. Since the Nambu - Jona-Lasinio 3-mass-state Higgs-as-TruthQuark-Condensate model predicts Higgs mass states around 200 GeV and 250 GeV

it is wrong to apply a LEE to histogram data analysis evaluating the model.

Still further, Slide 4 says “... Full coverage of a broad m_X range is crucial to maximize the sensitivity to different ... theoretical models

(higgs SM sector + scalar, doublet, triplet ...) ...” but there is no mention ...

of the Nambu - Jona-Lasinio 3-mass-state Higgs-as-TruthQuark-Condensate model despite the fact that it is a straightforward extension of the higgs SM sector

that gives testable predictions of mass states that are observable

in the Golden Channel Higgs $\rightarrow ZZ \rightarrow 4l$.

The ATLAS presentation at LHCP Bologna 2018 by Kunihiro Nagano shows on Slide 15 a histogram for $H \rightarrow ZZ \rightarrow 4l$ with 79.8 fb⁻¹ but it is only for m_{4l} from 80 to 170 GeV so it is not relevant for excesses around 200 GeV or 250 GeV. Slide 15 referred to ATLAS-CONF-2018-018 which is dated 4 June 2018 and said

“... The Higgs boson candidates within a mass window of 115 GeV < m_{4l} < 130 GeV are selected ...” so it also is not relevant for excesses around 200 GeV or 250 GeV.

**A reasonable analysis of Fermilab data
supports 3 Truth Quark Mass States of E8 Physics:
1994 CDF observation of Truth Quark**

26 April 1994 - FERMILAB-PUB-94/097E

A semileptonic histogram showed **three mass states of the Truth quark**

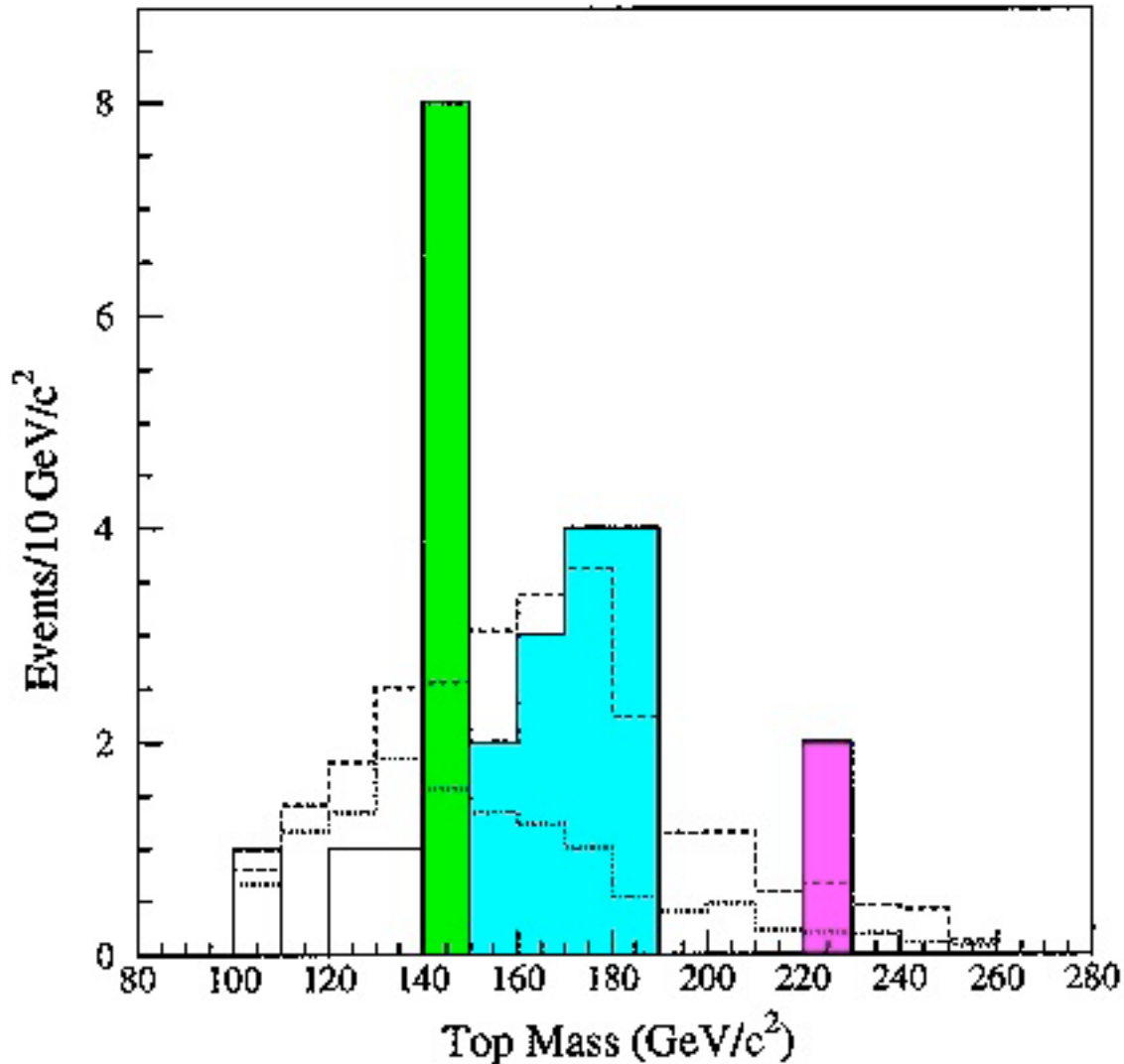

The **green** bar represents a bin in the **140-150 GeV** range consistent with the E8 Physics prediction of a Truth Quark Ground State around 130 GeV.

This peak was rejected by CDF Fermilab on the (in my opinion spurious) grounds "... We assume the mass combinations in the 140 to 150 GeV/c² bin represent a statistical fluctuation since their width is narrower than expected for a top signal ...".

The **cyan** bar represents a broader peak in the **160-180 GeV** range consistent with the 174 GeV mass state of the Truth Quark that is accepted by the Consensus of the Physics Community as the one and only mass state of the Truth Quark.

The **magenta** bar represents a bin in the **220-230 GeV** range consistent with the E8 Physics prediction of a Truth Quark Ground State around 220 GeV.

This peak was rejected by CDF Fermilab as too small (only 2 events) to be significant.

1997 D0 observation of Truth Quark

1997 - D0 hep-ex/9703008

A semileptonic histogram also showed **three states of the Truth Quark**

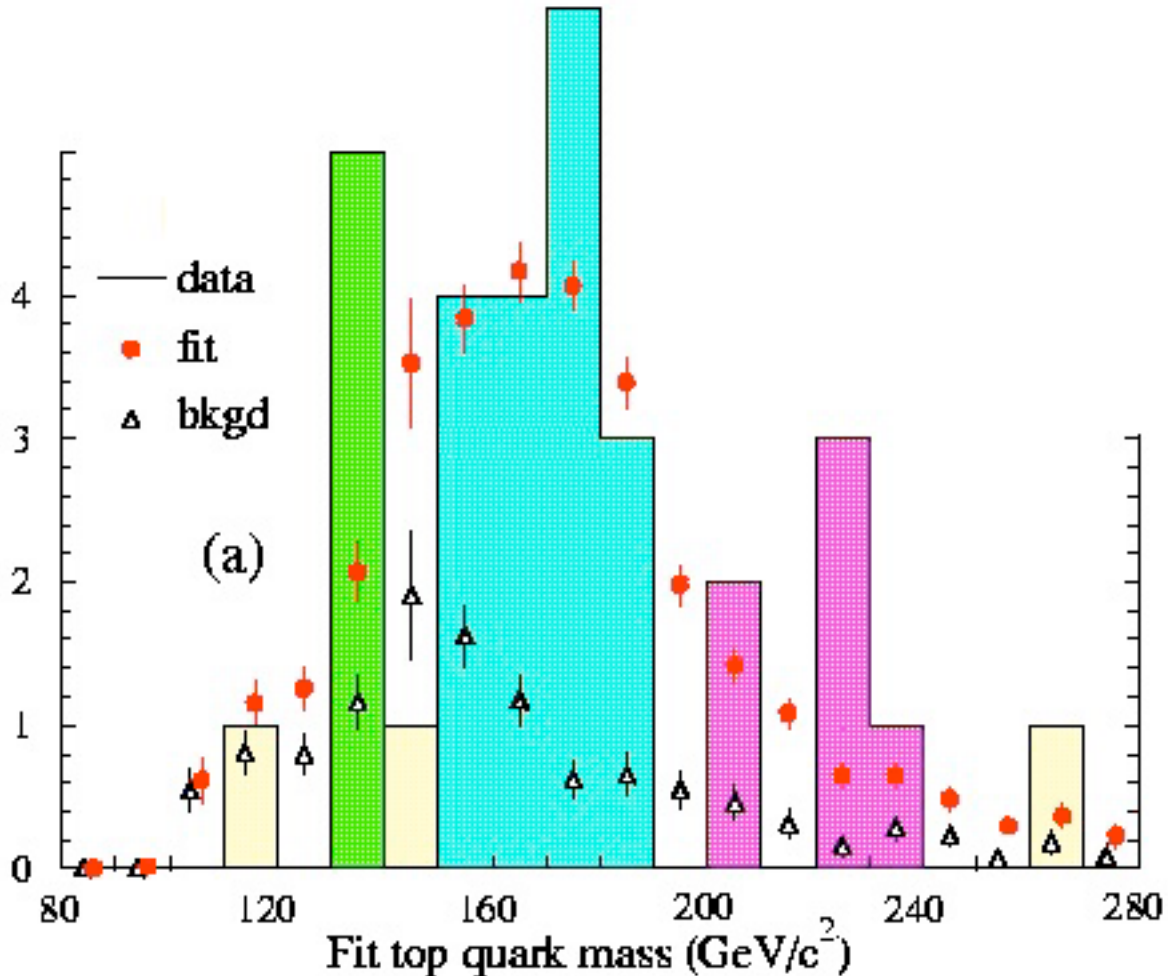

Despite confirmation of the Truth Quark Ground State around 130-140 GeV by D0 **Fermilab continued (and continues to the present day) to refuse to accept it.**

Fermilab happily accepted the confirmation of the Truth Quark state around 174 GeV.

Despite D0 having 6 events (not just 2) for Truth Quark in the 200-240 GeV range Fermilab continued (and continues to the present day) to refuse to accept it.

In Tommaso Dorigo's blog entry "Proofread my PASCOS 2006 proceedings" 5 Sep 2007 particularly comment 11 (by me) and comment 13 (Tommaso's reply to 11):
I asked: "... With respect to the CDF figure ...[and]... the D0 figure ... **what are the odds of such large fluctuations [green peaks] showing up at the same energy level in two totally independent sets of data ? ...**".

Tommaso replied: "... It is **of the order of 4-sigma.** ...".

1997 - Low, Middle, High-mass Tquark - Varnes U. C. Berkeley Ph.D. Thesis
FERMILAB-THESIS-1997-28

https://www-d0.fnal.gov/results/publications_talks/thesis/varnes/thesis.ps

In his 1997 Ph.D. thesis Erich Ward Varnes (page 159) said:

"... distributions for the dilepton candidates. For events with more than two jets, the dashed curves show the results of considering only the two highest ET jets in the reconstruction ...

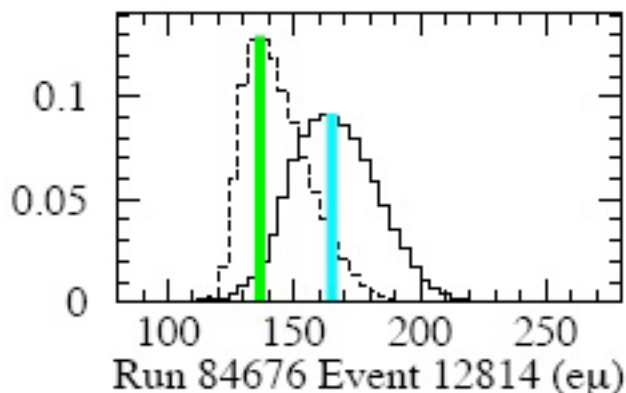

..." (colored bars added by me)

The event for all 3 jets (solid curve) seems to me to correspond to decay of a middle (cyan) T-quark state with one of the 3 jets corresponding to decay from the Triviality boundary to the Normal Stable Region (green) T-quark state, whose immediately subsequent decay corresponds to the 2-jet (dashed curve) event at the low (green) energy level.

In the Varnes thesis there is one dilepton event with 3 jets (solid curve)

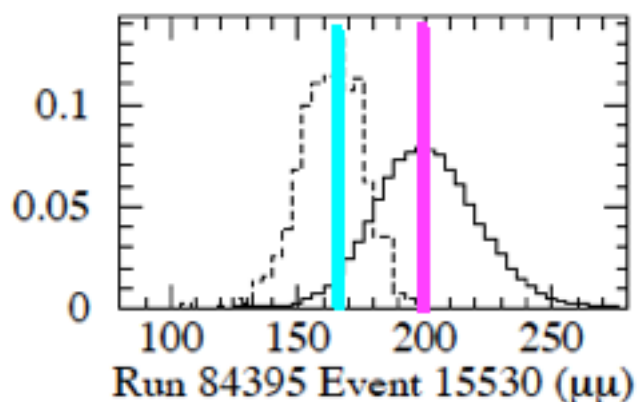

that seems to me to correspond to decay of a high (magenta) T-quark state with one of the 3 jets corresponding to decay from the Critical Point down to the Triviality Boundary (cyan) T-quark state, whose immediately subsequent decay corresponds to the 2-jet (dashed curve) event.

1998 - Low, Middle-mass Tquark - Dalitz, Goldstein hep-ph/9802249 -
 11 additional CDF dilepton events which have become available since the 1997
 Electron-Photon conference in Hamburg are **Low and Middle-mass Tquark states:**

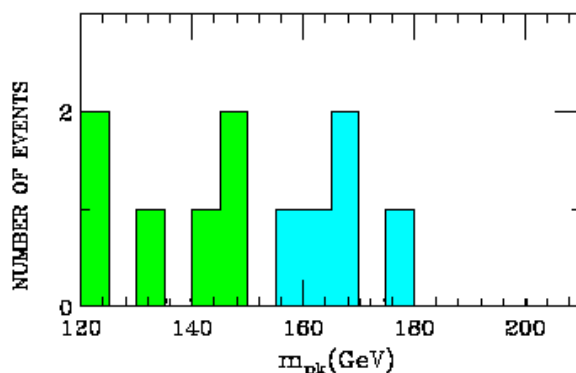

The distribution of m_{pt} values determined from 11 CDF dilepton events available empirically.

1998 - Low, Middle-mass Tquark - CDF hep-ex/9810029 -
 CDF “present[s] a new measurement of the top quark mass ...
 [that] supersedes [CDF’s] previously reported result in the dilepton channel”
 which revision seems to me to be cutting the lowest 3 of the 11 original events

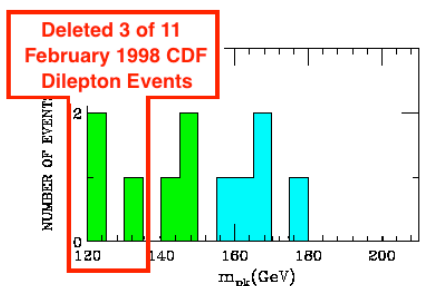

The distribution of m_{pt} values determined from 11 CDF dilepton events available empirically.

1998 Revision of

CDF Dilepton Criteria

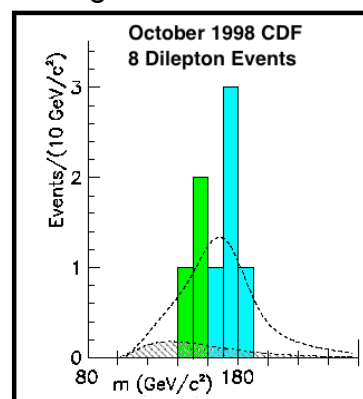

as part of a Fermilab policy of ignoring the Low-mass Tquark state.

1983 - Alvarez-Gaume, Polchinski, and Wise in Nuclear Physics B221 (1983)
 495-523 : “... The renormalization group equation ... tends to attract the top quark mass
 towards a fixed point of about 125 GeV ...”.

1984 - Ibanez and Lopez in Nuclear Physics B233 (1984) 511-544 did supergravity
 calculations similar to Alvarez-Gaume, Polchinski, and Wise.

1993 - Chamseddine and Frohlich in hep-ph/9307209 :
 “... **Connes ... non-commutative geometry [NCG]** provides a geometrical
 interpretation of the Higgs field ... the only solutions ... occur in the narrow band ...
 Higgs mass $117.3 < m_H < 142.6$ GeV ...
 with ... corresponding top quark mass ... $146.2 < m_t < 147.4$ GeV ...”.
 Later NCG calculation (arXiv 1204.0328) gave $m_t \leq \sqrt{8/3} m_W = 130$ GeV .

24x24 traceless symmetric matrices carry Bohm Quantum Potential as the Quantum Bohmion

The 24x24 Real Symmetric Matrices form the Jordan Algebra $J(24, \mathbb{R})$.

Jordan algebras correspond to the matrix algebra of quantum mechanical states, that is, from a particle physics point of view, the configuration of particles in spacetime upon which the gauge groups act.

24-Real-dim space has a natural Octonionic structure of 3-Octonionic-dim space.

The corresponding Jordan Algebra is $J(3, \mathbb{O}) = 3 \times 3$ Hermitian Octonion matrices.

Their 26-dim traceless part $J(3, \mathbb{O})_0$ describes the 26-dim of Bosonic String Theory and the algebra of its Quantum States, so that

the 24x24 traceless symmetric spin-2 particle is the Quantum Bohmion carrier of the Bohm Potential

The 26D String Theory gives massless 24x24 symmetric traceless matrices that have been misinterpreted by most physicists as a graviton but are really the carriers of the Bohm Quantum Potential for which Roderick Sutherland (arXiv 1509.02442) has given a Lagrangian that has been extended by Jack Sarfatti to include nonlinear Back-Reaction that enables Penrose-Hameroff Quantum Consciousness and Free Will, justifying Clifford's characterization of Real Clifford Algebras as

"... mind-stuff tak[ing] the form of ... human consciousness ..."

Sarfatti-Bohm Quantum Potential emerges from 26D E8 World-Line String Theory so is treated separately from the Local Classical E8 Lagrangian in 8D (or in 4D) describing the Standard Model and Gravity+Dark Energy plus Propagator Phase.

Roderick Sutherland (arXiv 1509.02442) gave a Lagrangian for the Bohm Potential saying: "... This paper focuses on interpretations of QM in which the underlying reality is taken to consist of particles have definite trajectories at all times ... An example ... is the Bohm model ... This paper ... provid[es]... a Lagrangian ...[for]... the unfolding events describing more than one particle while maintaining a relativistic description requires the introduction of final boundary conditions as well as initial, thereby entailing retrocausality ...

In addition ... the Lagrangian approach pursued here to describe particle trajectories

also entails the natural inclusion of an accompanying field to influence the particle's motion away from classical mechanics and reproduce the correct quantum predictions. In so doing, it is ... providing a physical explanation for why quantum phenomena exist at all ... **the particle is seen to be**

the source of a field which alters the particle's trajectory via self-interaction ...

The Dirac case ... each particle in an entangled many-particle state will be described by an individual Lagrangian density ... of the form:

$$\mathcal{L} = \text{Re} \left[\frac{1}{\langle f|i \rangle} \left(-i\bar{\Psi}_f \gamma^\alpha \partial_\alpha \Psi_i + m\bar{\Psi}_f \Psi_i \right) \right] \mp \sigma_0 \rho_0 \left| u_\alpha u^\alpha \right|^{1/2} + \sigma_0 u_\alpha j^\alpha$$

... the ...[first]... term ...[is]... the ... Lagrangian densities for the PSI field alone ...

... sigma_o is the rest density distribution of the particle through space ... j is the current density ...

... rho_o and u are the rest density and 4-velocity of the probability flow ...”.

Jack Sarfatti extended the Sutherland Lagrangian to include Back-Reaction

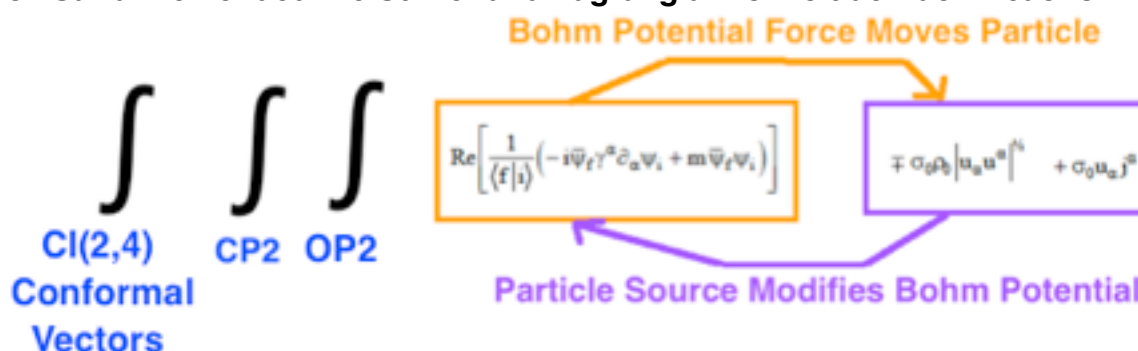

where a, b and VM4 form CI(2,4) vectors and VCP2 forms CP2 and S+ and S- form OP2 so that

26D = 16D orbifolded fermions + 10D and 10D = 6D Conformal Space + 4D CP2 ISS (ISS = Internal Symmetry Space and 6D Conformal contains 4D M4 of Kaluza-Klein M4xCP2)

saying (linkedin.com Pulse 13 January 2016): "... the reason entanglement cannot be used as a direct messaging channel between subsystems of an entangled complex quantum system, is the lack of direct back-reaction of the classical particles and classical local gauge fields on their shared entangled Bohmian quantum information pilot wave ... Roderick. I. Sutherland ... using Lagrangian field theory, shows how to make the original 1952 Bohm pilot-wave theory completely relativistic, and how to avoid the need for configuration space for many-particle entanglement.

The trick is that final boundary conditions on the action as well as initial boundary conditions influence what happens in the present.

The general theory is "post-quantum" ... and it is non-statistical ...

There is complete two-way action-reaction between quantum pilot waves and the classical particles and classical local gauge fields ...

orthodox statistical quantum theory, with no-signaling ...[is derived]... in two steps,

first arbitrarily set the back-reaction (of particles and classical gauge field on their pilot waves) to zero. This is analogous to setting the curvature equal to zero in general relativity, or more precisely in setting G to zero.

Second, integrate out the final boundary information, thereby adding the statistical Born rule to the mix. ...

the mathematical condition for zero post-quantum back-reaction of particles and classical fields (aka "beables" J.S. Bell's term) is exactly de Broglie's guidance constraint. That is, in the simplest case, the classical particle velocity is proportional to the gradient of the phase of the quantum pilot wave. It is for this reason, that the independent existence of the classical beables can be ignored in most quantum calculations.

However, orthodox quantum theory assumes that the quantum system is thermodynamically closed between strong von Neumann projection measurements that obey the Born probability rule.

The new post-quantum theory in the equations of Sutherland, prior to taking the limit of orthodox quantum theory, should apply to pumped open dissipative structures. Living matter is the prime example. ...". Jack Sarfatti (email 31 January 2016) said:
"... post-quantum theory with action-reaction between quantum information pilot wave and its be-able is compatible with free will. ..."

Sarfatti-Bohm-Penrose-Hameroff Quantum Consciousness

In "Space-Time Code. III" Phys. Rev. D (1972) 2922-2931 David Finkelstein said
"... The primitive quantum processes or chronons of which world lines are made can be thought of as acts of emission or creation, Their duals, antichronons, represent acts of absorption or annihilation. ..."

The Creation-Annihilation Operator structure of the Bohm Quantum Potential of 26D String Theory is given by the

Maximal Contraction of $E_8 = \text{semidirect product } A_7 \times h_{92}$
 where $h_{92} = 92+1+92 = 185\text{-dim Heisenberg algebra}$ and $A_7 = 63\text{-dim } SL(8)$

The Maximal E_8 Contraction $A_7 \times h_{92}$ can be written as a 5-Graded Lie Algebra

$$28 + 64 + (SL(8, \mathbb{R}) + 1) + 64 + 28$$

$$\text{Central Even Grade } 0 = SL(8, \mathbb{R}) + 1$$

The 1 is a scalar and $SL(8, \mathbb{R}) = \text{Spin}(8) + \text{Traceless Symmetric } 8 \times 8 \text{ Matrices}$,
 so $SL(8, \mathbb{R})$ represents a local 8-dim SpaceTime in Polar Coordinates.

$$\text{Odd Grades } -1 \text{ and } +1 = 64 + 64$$

Each = $64 = 8 \times 8 = \text{Creation/Annihilation Operators for 8 components of 8 Fundamental Fermions.}$

$$\text{Even Grades } -2 \text{ and } +2 = 28 + 28$$

Each = Creation/Annihilation Operators for 28 Gauge Bosons of Gravity + Standard Model.

The 8x8 matrices linking one D8 to the next D8 of a World-Line String give $A_{7 \times R} = U(8)$

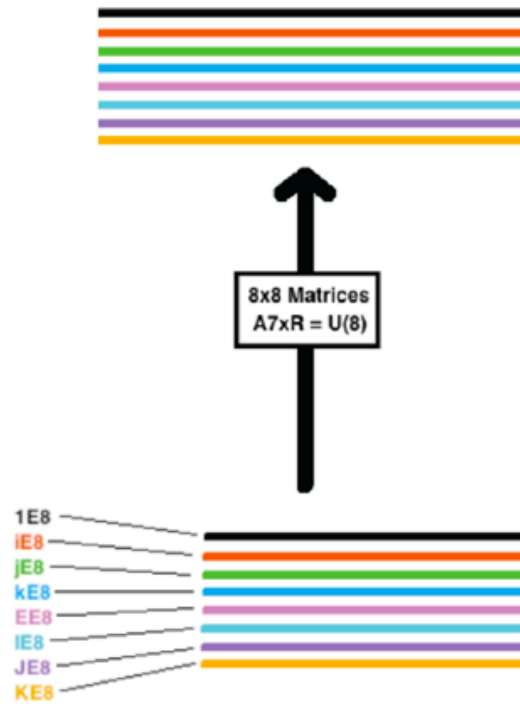

26D String Theory Structure is

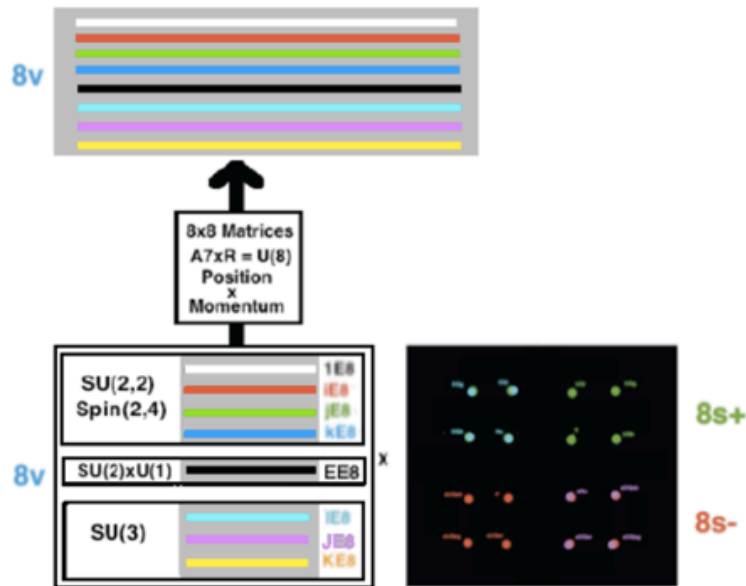

Green, Schwartz, and Witten, in "Superstring Theory" vol. 1, describe 26D String Theory saying "... The first excited level ... consists of ...

the ground state ... **tachyon** ...

and ... a scalar ... '**dilaton**' ...

and ... **SO(24)** ... **little group of a ...[26-dim]... massless particle** ...

and ... a ... **massless ... spin two state** ...".

Tachyons localized at orbifolds of fermions produce virtual clouds of particles / antiparticles that dress fermions by filling their Schwinger Source regions.

Dilatons are Goldstone bosons of spontaneously broken scale invariance that (analogous to Higgs) go from mediating a long-range scalar gravity-type force to the nonlocality of the Bohm-Sarfatti Quantum Potential.

The SO(24) little group is related to the Monster automorphism group that is the symmetry of each cell of Planck-scale local lattice structure.

The massless spin 2 state = Bohmion = Carrier of the Bohm Force of the Bohm Quantum Potential.

Similarity of the spin 2 Bohmion to the spin 2 Graviton accounts for the Bohmion's ability to support Penrose Consciousness with Superposition Separation Energy Difference $G m^2 / a$

where, for a Human Brain, m = mass of electron and a = 1 nanometer in Tubulin Dimer

"... Bohm's Quantum Potential can be viewed as an internal energy of a quantum system ..."

according to Dennis, de Gosson, and Hiley (arXiv 1412.5133)

and

Bohm Quantum Potential inherits Sarfatti Back-Reaction from its spin-2 structure similar to General Relativity

Peter R. Holland says in "The Quantum Theory of Motion" (Cambridge 1993):

"... the total force ... from the quantum potential ... does not ... fall off with distance ... because ... the quantum potential ... depends on the form of ...[the quantum state]... rather than ... its ... magnitude ...".

Penrose-Hameroff-type Quantum Consciousness is due to Resonant Quantum Potential Connections among Quantum State Forms.

The Quantum State Form of a Conscious Brain is determined by the configuration of a subset of its 10^{18} to 10^{19} Tubulin Dimers described by a large Real Clifford Algebra. Paola Zizzi in gr-qc/0007006 describes the Octonionic Inflation Era of Our Universe as a Quantum Consciousness Superposition of States ending with Self-Decoherence after 64 doublings of Octonionic Inflation, at which time Our Universe is "... a superposed state of quantum ... [qubits].

the self-reduction of the superposed quantum state is ... reached at the end of inflation ...[at]... the decoherence time ... [$T_{\text{decoh}} = 10^9 T_{\text{planck}} = 10^{(-34)}$ sec] ... and corresponds to a superposed state of ... [$10^{19} = 2^{64}$ qubits]. ...".

64 doublings to 2^{64} qubits corresponds to the Clifford algebra

$$Cl(64) = Cl(8 \times 8) = Cl(8) \times Cl(8) \times Cl(8) \times Cl(8) \times Cl(8) \times Cl(8) \times Cl(8) \times Cl(8)$$

By the periodicity-8 theorem of Real Clifford algebras, $Cl(64)$ is the smallest Real Clifford algebra for which we can reflexively identify each component $Cl(8)$ with a basis vector in the $Cl(8)$ vector space.

This reflexive identification causes our universe to decohere at $N = 2^{64} = 10^{19}$. Octonionic Quantum Processes are Not Unitary and so can produce Fermions.

(see Stephen Adler's book "Quaternionic Quantum Mechanics ..." at pages 50-52 and 561).

At the end of 64 Unfoldings, Non-Unitary Octonionic Inflation ended having produced about $(1/2) 16^{64} = (1/2) (2^4)^{64} = 2^{255} = 6 \times 10^{76}$ Fermions.

At the End of Inflation Our Universe had Temperature / Energy 10^{27} K = 10^{14} GeV so each of the 10^{77} Fermions had energy of 10^{14} GeV and collisions among them would for each of the 10^{77} Fermions produce jets containing about 10^{12} particles of energy 100 GeV or so so that the total number created by Inflation was about 10^{89} .

The End of Inflation time was at about $10^{(-34)}$ sec = $2^{64} T_{\text{planck}}$ and

the size of our Universe was then about $10^{(-24)}$ cm which is about the size of a Fermion Schwinger Source Kerr-Newman Cloud.

The 2^{64} qubits created by Inflation is roughly 10^{19} which is roughly the number of Quantum Consciousness Tubulins in the Human Brain.

Therefore

the Human Brain Quantum Consciousness has evolved in Our Universe to be roughly equivalent to the Maximum Consciousness of Our Inflationary Era Universe.

Further,

each cell of E8 Lagrangian Spacetime corresponds to 65,536-dim $Cl(16)$

which contains 248-dim E8 = 120-dim D8 bivectors +128-dim D8 half-spinors
 Human Brain Microtubules 40 microns long have 65,536 Tubulin Dimers



(image adapted from 12biophys.blogspot.com Lecture 11)

and so

can have Bohm Quantum Resonance with Cl(16) Spacetime cells
 so that **at any and all Times**

**the State of Consciousness of a Human is in exact resonant correspondence with
 a subset of the cells of E8 Classical Lagrangian Spacetime**

Therefore

**E8 Lagrangian Spacetime (as a Nambu-Jona-Lasinio Condensate)
 is effectively the Spirit World**

in which the Human States of Consciousness = Souls exist.

After the death of the Human Physical Body the Spirit World interactions with its Soul
 are no longer constrained by Physical World interactions with its Body so that
 the Spirit World can harmonize the individual Soul with the collective Universal Soul.

**A Single Cell of E8 26-dimensional Bosonic String Theory,
 in which Strings are physically interpreted as World-Lines,
 can be described by taking the quotient of its 24-dimensional O+, O-, Ov
 subspace modulo the 24-dimensional Leech lattice.
 Its automorphism group is the largest finite sporadic group, the Monster Group,
 whose order is**

$$8080, 17424, 79451, 28758, 86459, 90496, 17107, 57005, 75436, 80000, 00000$$

$$=$$

$$2^{46} \cdot 3^{20} \cdot 5^9 \cdot 7^6 \cdot 11^2 \cdot 13^3 \cdot 17 \cdot 19 \cdot 23 \cdot 29 \cdot 31 \cdot 41 \cdot 47 \cdot 59 \cdot 71$$

or about 8×10^{53} .

“... **Bohm’s Quantum Potential can be viewed as an internal energy** of a quantum
 system ...” according to Dennis, de Gosson, and Hiley (arXiv 1412.5133) and
 Peter R. Holland says in "The Quantum Theory of Motion" (Cambridge 1993): "... **the total force ...
 from the quantum potential ... does not ... fall off with distance ...**
 because ... the quantum potential ... depends on the form of ...[the quantum state]...
 rather than ... its ... magnitude ...".

**Penrose-Hameroff-type Quantum Consciousness is due
 to Resonant Quantum Potential Connections among Quantum State Forms.**
 The Quantum State Form of a Conscious Brain is determined by

the configuration of a subset of its 10^{18} to 10^{19} Tubulin Dimers
with math description in terms of a large Real Clifford Algebra:

Resonance is discussed by Carver Mead in "Collective Electrodynamics" (MIT 2000):
"... we can build ... a resonator from ... electric dipole ... configuration[s] ...



[such as Tubulin Dimers]

Because there are charges at the two ends of the dipole, we can have a contribution to the electric coupling from the scalar potential ... as well [as] from the magnetic coupling ... from the vector potential ... electric dipole coupling is stronger than magnetic dipole coupling ... the coupling of ... two ... configurations ... is the same, whether retarded or advanced potentials are used. Any ... configuration ... couples to any other on its light cone, whether past or future. ... The total phase accumulation in a ... configuration ... is the sum of that due to its own current, and that due to currents in other ... configurations ... far away ...

The energy in a single resonator alternates between the kinetic energy of the electrons (inductance), and the potential energy of the electrons (capacitance). With the two resonators coupled, the energy shifts back and forth between the two resonators in such a way that the total energy is constant ... The conservation of energy holds despite an arbitrary separation between the resonators ... Instead of scaling linearly with the number of charges that take part in the motion, the momentum of a collective system scales as the square of the number of charges! ... The inertia of a collective system, however, is a manifestation of the interaction, and cannot be assigned to the elements separately. ... Thus, it is clear that collective quantum systems do not have a classical correspondence limit. ...".

For the 10^{18} Tubulin Dimers of the human brain,
the resonant frequencies are the same and exchanges of energy among them
act to keep them **locked in a Quantum Protectorate collective coherent state**.

Philip W. Anderson in cond-mat/0007287 and cond-mat/007185 said:

"... Laughlin and Pines have introduced the term "Quantum protectorate" as a general descriptor of the fact that certain states of quantum many-body systems exhibit properties which are unaffected by imperfections, impurities and thermal fluctuations. They instance ... flux quantization in superconductors, equivalent to the Josephson frequency relation which again has mensuration accuracy and is independent of imperfections and scattering. ...

... the source of quantum protection is a collective state of the quantum field involved such that the individual particles are sufficiently tightly coupled that elementary excitations no longer involve a few particles but are collective excitations of the whole system, and therefore, macroscopic behavior is mostly determined by overall conservation laws ... **a "quantum protectorate" ... [is]... a state in which the many-body correlations are so strong that the dynamics can no longer be described in terms of individual particles, and therefore perturbations which scatter individual particles are not effective ...**"

Mershin, Sanabria, Miller, Nawarathna, Skoulakis, Mavromatos, Kolomenskii, Scheussler, Ludena, and Nanopoulos in physics/0505080 "Towards Experimental Tests of Quantum Effects in Cytoskeletal Proteins" said:



Classically, the various dimers can only be in the ...[those]... conformations. Each dimer is influenced by the neighboring dimers resulting in the possibility of a transition. This is the basis for classical information processing, which constitutes the picture of a (classical) cellular automaton. If we assume ... that each dimer can find itself in a QM superposition of ...[those]... states, a quantum nature results. Tubulin can then be viewed as a typical two-state quantum mechanical system, where the dimers couple to conformational changes with $10^{(-9)} - 10^{(-11)}$ sec transitions, corresponding to an angular frequency $\sim 10^{10} - 10^{12}$ Hz. In this approximation, the upper bound of this frequency range is assumed to represent (in order of magnitude) the characteristic frequency of the dimers, viewed as a two-state quantum-mechanical system ...[

The Energy Gap of our Universe as superconductor condensate spacetime is from $3 \times 10^{(-18)}$ Hz (radius of universe) to 3×10^{43} Hz (Planck length). Its RMS amplitude is 10^{13} Hz = 10 THz = energy of neutrino masses = critical temperature T_c of BSCCO superconducting crystal Josephson Junctions]... large-scale quantum coherence ...[has been observed]... at temperatures within a factor of three of biological temperatures. MRI magnets contain hundreds of miles of superconducting wire and routinely carry a persistent current. There is no distance limit - the macroscopic wave function of the superfluid condensate of electron pairs, or Cooper pairs, in a sufficiently long cable could maintain its quantum phase coherence for many thousands of miles ... there is no limit to the total mass of the electrons participating in the superfluid state. The condensate is "protected" from thermal fluctuations by the BCS energy gap at the Fermi surface ... The term "quantum protectorate" ... describe[s] this and related many-body systems ...".

The Human Brain has about 10^{11} Neuron cells, each about 1,000 nm in size.
 The cytoskeleton of cells, including neurons of the brain, is made up of Microtubules

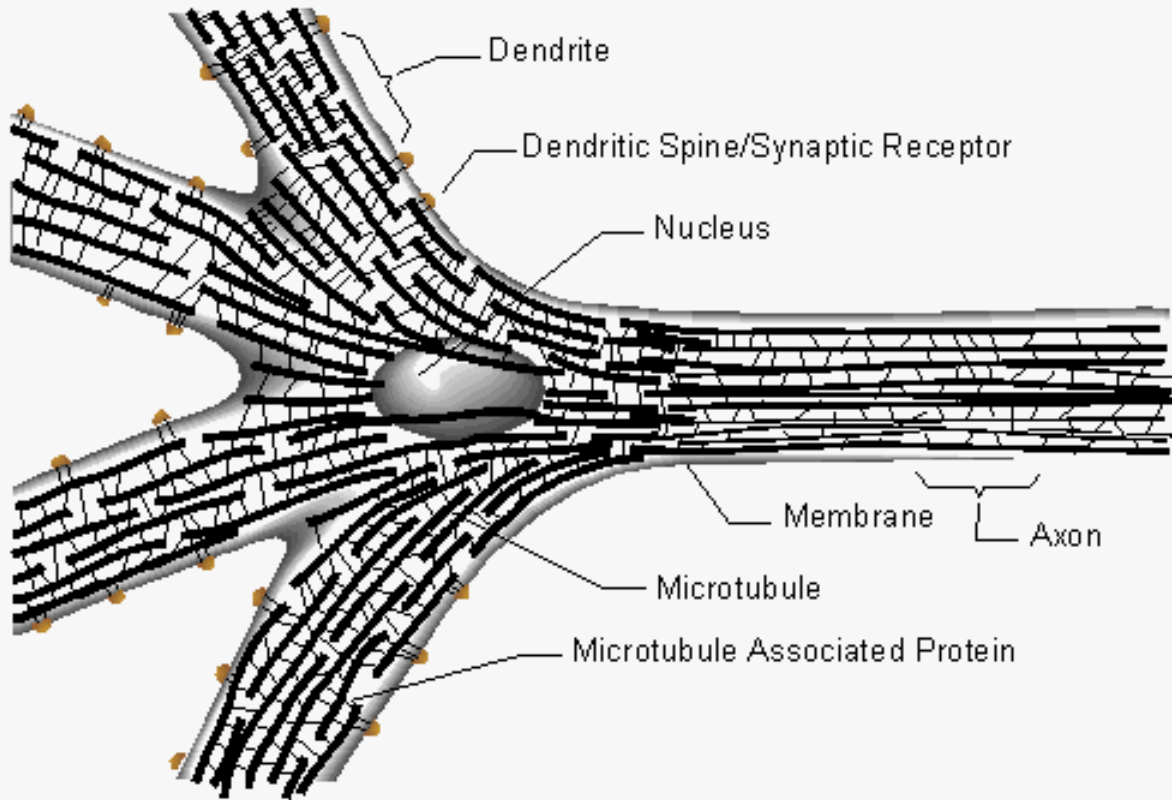

(image from "Orchestrated Objective Reduction of Quantum Coherence in Brain Microtubules: The "Orch OR" Model for Consciousness" by Penrose and Hameroff)

Each Neuron contains about 10^9 Tubulin Dimers, organized into Microtubules some of which are organized by a Centrosome. Centrosomes contain a pair of Centrioles.

A Centriole is about 200 nm wide and 400 nm long. Its wall is made up of 9 groups of 3 Microtubules, reflecting the symmetry of 27-dim $J(3,0)$

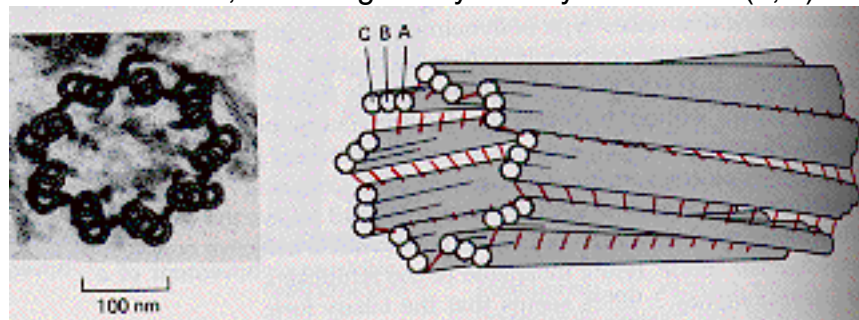

Each Microtubule is a hollow cylindrical tube with about 25 nm outside diameter and 14 nm inside diameter, made up of 13 columns of Tubulin Dimers

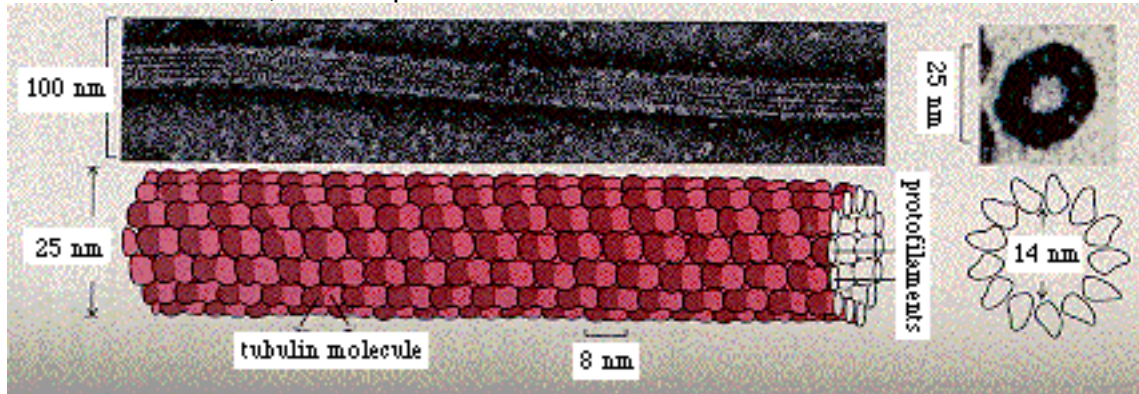

(illustrations and information about cells, microtubules, and centrioles are from Molecular Biology of the Cell, 2nd ed, by Alberts, Bray, Lewis, Raff, Roberts, and Watson (Garland 1989))

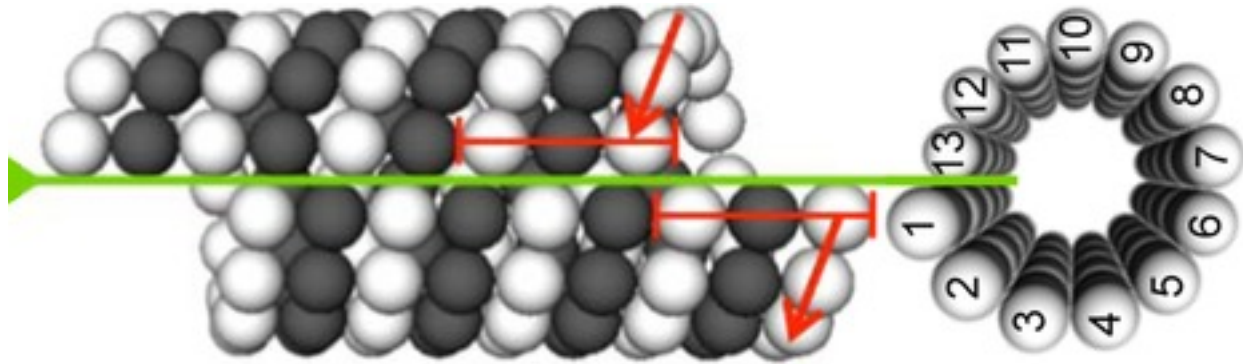

(image from Wikipedia on Microtubule)

Each Tubulin Dimer is about 8 nm x 4 nm x 4 nm, consists of two parts, alpha-tubulin and beta-tubulin (each made up of about 450 Amino Acids, each containing roughly 20 Atoms)
 A Microtubule 40 microns = 40,000 nm long contains $13 \times 40,000 / 8 = 65,000$ Dimers



(images adapted from nonlocal.com/hbar/microtubules.html by Rhett Savage)

The black dots indicate the position of the Conformation Electrons.

There are two energetically distinct configurations for the Tubulin Dimers:

Conformation Electrons Similarly Aligned (left image) - State 0

Conformation Electrons Maximally Separated (right image) - State 1

The two structures - State 0 ground state and State 1 higher energy state - make Tubulin Dimers the basis for a Microtubule binary math / code system.

Microtubule binary math / code system corresponds to Clifford Algebras $Cl(8)$ and $Cl(8) \times Cl(8) = Cl(16)$ containing 16-dim V16 (magenta) and 120 (inside purple outline) + 128-dim (yellow green red) = 248-dim E8 and 560 (inside black outline) 10 copies of 56-dim $Fr_3(O)$:

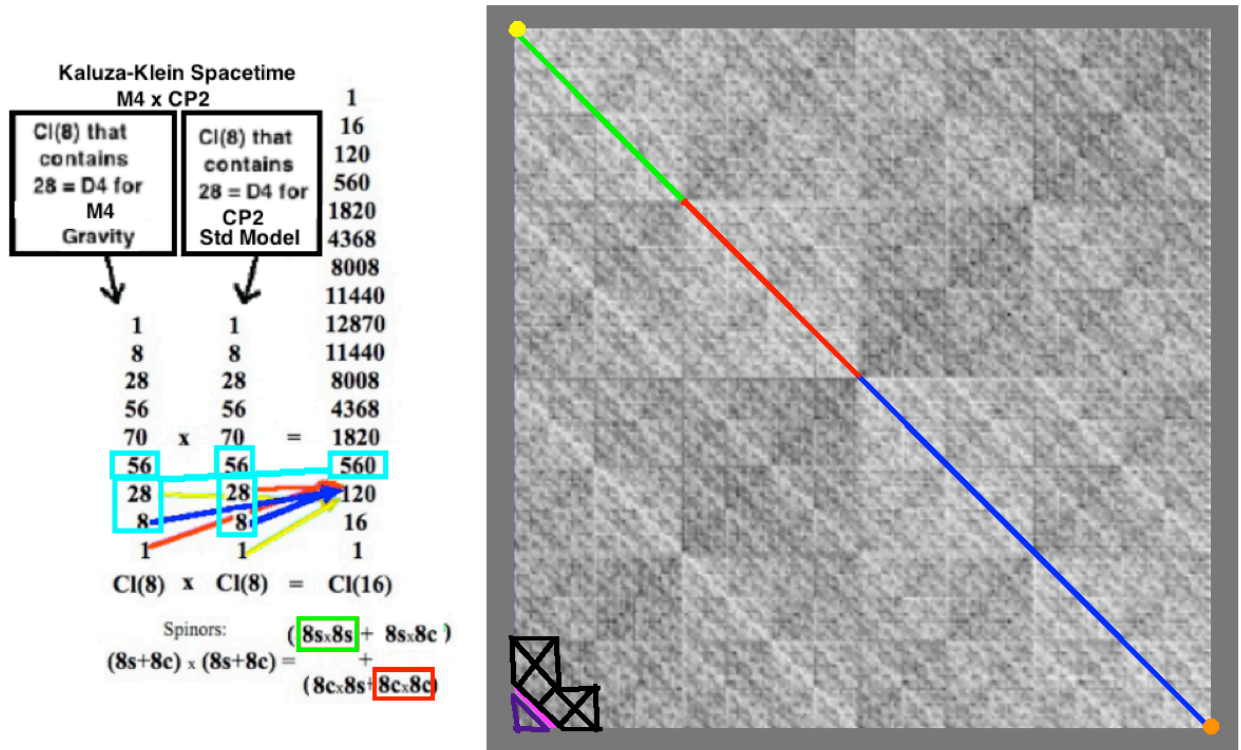

That leaves 1 (orange) + and 127 (blue) = 128-dim Mirror Fermion half-spinors and $65,536 - 256 - 560 - 120 - 16 = 64,584$ elements of $Cl(16)$ available to carry information in the processes of Quantum Consciousness.

According to 12biophys.blogspot.com Lecture 11 Microtubule structure is dynamic: "... One end of the microtubule is composed of stable (GTP) monomers while the rest of the tubule is made up of unstable (GDP) monomers. The GTP end comprises a cap of stable monomers. Random fluctuations either increase or decrease the size of the cap. This results in 2 different dynamic states for the microtubule. Growing: cap is present Shrinking: cap is gone ...

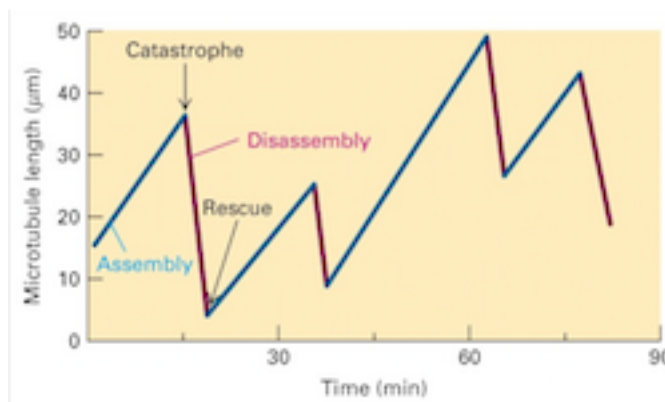

Microtubules spend most of their lives between 10 microns and 40 microns, sizes that can represent E8 as half of the Even Part (half) of Cl(16) (10 microns)

$$248 \text{ E8} = 120 \text{ D8 Vector } \square + 128 \text{ D8 Half-Spinor } \text{---}$$

<p>128 x 128 = Half of Even Part of Cl(16) 16,384 Tubulin Dimers in 10 micron MicroTubule</p>		<p>2 x (128 x 128) Even Part of Cl(16) 32,768 Tubulin Dimers in 20 micron MicroTubule</p>	<p>256 x 256 = Cl(16) 65,536 Tubulin Dimers in 40 micron MicroTubule</p>

or as the Even Part (half) of Cl(16) (20 microns) or as full Cl(16) (40 microns).

In a given Microtubule
 the 128 D8 Half-Spinor part  is represented by a line of 128
 Dimers in its stable GTP region
 and

the 120 D8 Vector part  by a 12 x 10 block of Dimers in its stable GTP region
 (image adapted from 12biophys.blogspot.com Lecture 11)



How do the Microtubules communicate with each other ?

Consider the Superposition of States State 0 and State 1 involving one Tubulin Dimer
 with Conformation Electron mass m and State1 / State 0 position separation a .

The Superposition Separation Energy Difference is the internal energy

$$E_{ssediff} = G m^2 / a$$

that can be seen as either the **energy of 26D String Theory spin two gravitons**
 or the **Bohm Quantum Potential internal energy**, equivalently.

Communication between two Microtubules is by the Bohm Quantum Potential
 between their respective corresponding Dimers
 with the correspondence being based on connection
 between respective E8 and Fr3(O) subsets

How is information encoded in the Microtubules ?

Each Microtubule contains E8 and Fr3(O),
 allowing Microtubules to be correlated with each other.
 The parts of the Microtubule beyond E8 and Fr3(O)
 are in Cl(16) for 40 micron Microtubules,
 or the Even Subalgebra of Cl(16) for 20 micron Microtubules,
 or half of the Even Subalgebra of Cl(16) for 10 micron Microtubules
 so since by 8-Periodicity of Real Clifford Algebras $Cl(16) = Cl(8) \times Cl(8)$ and
 since Cl(8) information is described by the Quantum Reed-Muller code $[[256 , 0 , 24]]$
**the information content of Cl(16) and its Subalgebras is described by the
 Tensor Product Quantum Reed-Muller code $[[256 , 0 , 24]]$ x $[[256 , 0 , 24]]$**

What about information in the Many Microtubules of Human Consciousness ?

The information in one Microtubule is based on CI(16)
which is contained in the CI(1,25) of 26D String Theory E8 Physics

How does this give rise to Penrose-Hameroff Quantum Consciousness ?

Consider the Superposition of States State 0 and State 1 involving one Tubulin Dimer with Conformation Electron mass m and State1 / State 0 position separation a .

The Superposition Separation Energy Difference is the internal energy

$$E_{\text{ssediff}} = G m^2 / a$$

that can be seen as the **energy of 26D String Theory spin two gravitons**
which physically represent the **Bohm Quantum Potential internal energy**.

(see Appendix - Details of World-Line String Bohm Quantum Theory)

For a given Tubulin Dimer $a = 1$ nanometer = 10^{-7} cm so that

$$T = h / E_{\text{electron}} = (\text{Compton} / \text{Schwarzschild}) (a / c) = 10^{26} \text{ sec} = 10^{19} \text{ years}$$

Now consider the case of N Tubulin Dimers in Coherent Superposition
connected by the Bohm Quantum Potential Force that does not fall off with distance.

Jack Sarfatti defines coherence length L by $L^3 = N a^3$ so that

the Superposition Energy E_N of N superposed Conformation Electrons is

$$E_N = G M^2 / L = N^{5/3} E_{\text{ssediff}}$$

The decoherence time for the system of N Tubulin Electrons is

$$T_N = h / E_N = h / N^{5/3} E_{\text{ssediff}} = N^{-5/3} 10^{26} \text{ sec}$$

so we have the following rough approximate Decoherence Times T_N

Number of Involved Tubulin Dimers	Time T_N
$10^{(11+9)} = 10^{20}$	$10^{(-33 + 26)} = 10^{(-7)} \text{ sec}$ 10^{11} neurons x 10^9 TD / neuron 10^{20} Tubulin Dimers in Human Brain

10^{16}	$10^{(-27 + 26)} = 10^{(-1)} \text{ sec} - 10 \text{ Hz}$ Human Alpha EEG is 8 to 13 Hz Fundamental Schumann Resonance is 7.8 Hz
-----------	--

Time of Traverse by a String World-Line Quantum Bohmion of a Quantum
Consciousness Hamiltonian Circuit of 10^{16} TD separated from nearest neighbors
by 10 nm is $10^{16} \times 10 \text{ nm} / c = (10^{16} \times 10^{(-6)}) \text{ cm} / c = 10^{10} \text{ cm} / c = 0.3 \text{ sec}$

Each cell of E8 Classical Lagrangian Spacetime corresponds to 65,536-dim Cl(16) which contains 248-dim E8 = 120-dim D8 bivectors +128-dim D8 half-spinors

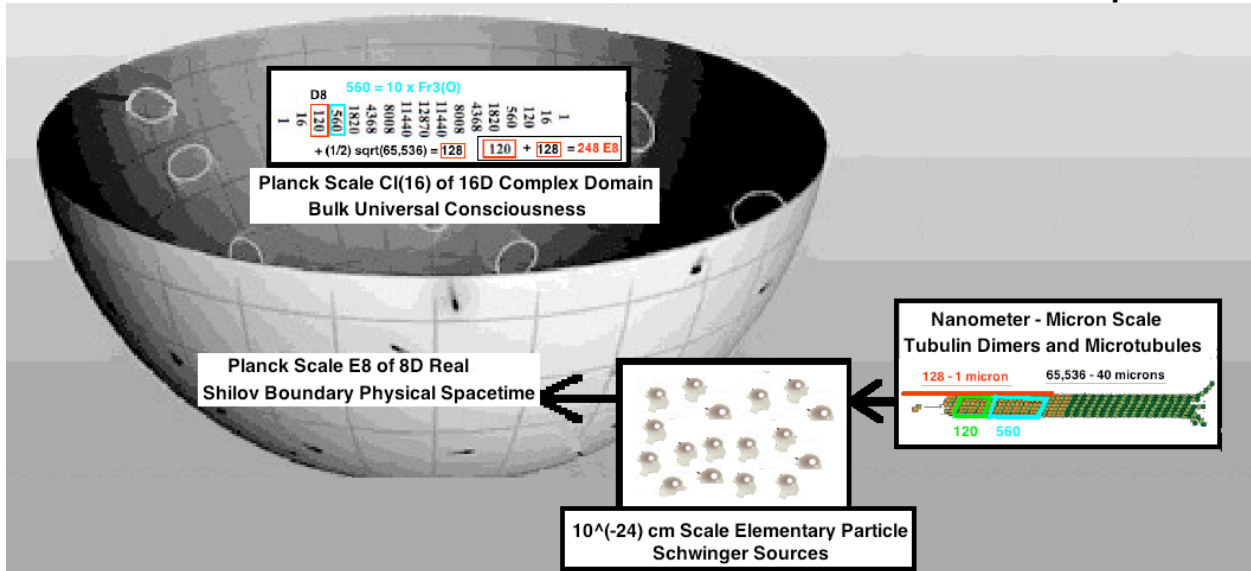

In E8 Physics (viXra 1602.0319)

Spacetime is the 8-dimensional Shilov Boundary RP1 x S7

of the Type IV8 Bounded Complex Domain Bulk Space

of the Symmetric Space Spin(10) / Spin(8)xU(1)

which **Bulk Space** has 16 Real dimensions

and is the Vector Space of the Real Clifford Algebra Cl(16).

By 8-Periodicity,

Cl(16) = tensor product Cl(8) x Cl(8) = Real 256x256 Matrix Algebra M(R,256)

and so has 256x256 = 65,536 elements.

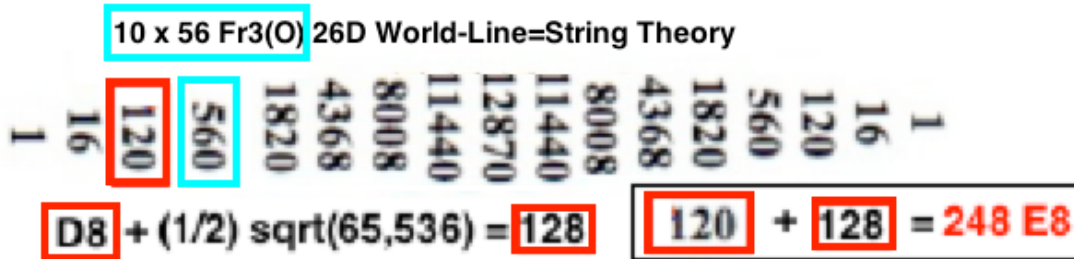

Cl(8) has 8 Vectors, 28 BiVectors, and 16 Spinors with 8+28+16 = 52 = F4 Lie Algebra.

Cl(16) has 120 BiVectors and 128 Half-Spinors for 120+128 = 248 = E8 Lie Algebra giving a Lagrangian for the Standard Model and for Gravity - Dark Energy.

Cl(16) has 560 TriVectors for 10 copies of Fr3(O) and Cl(1,25) AQFT

so 65,536 - 248 - 560 = 64,728 elements of Cl(16) are for Consciousness Information.

The Complex Bulk Space Cl(16)

contains the Maximal Contraction of E8 which is H92 + A7

a generalized Heisenberg Algebra of Quantum Creation-Annihilation Operators with graded structure

$$28 + 64 + ((SL(8,R)+1) + 64 + 28$$

We live in the Physical Minkowski M4 part
of Kaluza-Klein M4 x CP2 structure of RP1 x S7 **Boundary**.
(where CP2 = SU(3) / SU(2)xU(1) is Internal Symmetry Space
of Standard Model gauge groups)

Our Consciousness is based on Binary States of Tubulin Dimers (each 4x4x8 nm size)
in Microtubules.



Microtubules are cylinders of sets of 13 Dimers with maximal length about 40,000 nm
so that
each Microtubule can contain about $13 \times 40,000 / 8 = 65,000$ Bits of Information.

The Physical Boundary in which we live
is a Real Shilov Boundary in which E8 is manifested
as Lagrangian Structure of Real Forms of E8
with Lagrangian Symmetric Space structure:

- E8 / D8 = (OxO)P2 for 8 componets of 8+8 First-Generation Fermions
- D8 / D4 x D4 for 8-dim spacetime position x 8-dim spacetime momentum
- D4 for Standard Model Gauge Bosons and Gravity - Dark Energy Ghosts
- D4 for Gravity - Dark Energy Gauge Bosons and Standard Model Ghosts

Microtubule Information in the Boundary
has Resonant Connection to Cl(16) Information in Bulk Space
by the spin-2 Bohm Quantum Potential with Sarfatti Back-Reaction
of 26D String Theory of World-Lines
consistent with Poisson Kernel as derivative of Green's function.

The Bulk Space Domain Type IV8
corresponds to the Symmetric Space Spin(10) / Spin(8)xU(1)
and is a Lie Ball whose Shilov Boundary RP1 x S7 is a Lie Sphere 8-dim Spacetime.

It is related to
the Stiefel Manifold $V(10,2) = \text{Spin}(10) / \text{Spin}(8)$ of dimension $20-3 = 17$ by the fibration
 $\text{Spin}(10) / \text{Spin}(8)xU(1) \rightarrow V(10,2) \rightarrow U(1)$

It can also be seen as a tube $z = x + iy$
whose imaginary part is physically inverse momentum
so that its points give both position and momentum
(R. **Coquereaux** Nuc. Phys. B. 18B (1990) 48-52) "Lie Balls and Relativistic Quantum Fields".

Human Brain Microtubules 40 microns long have 65,536 Tubulin Dimers

128 - 1 micron

65,536 - 40 microns

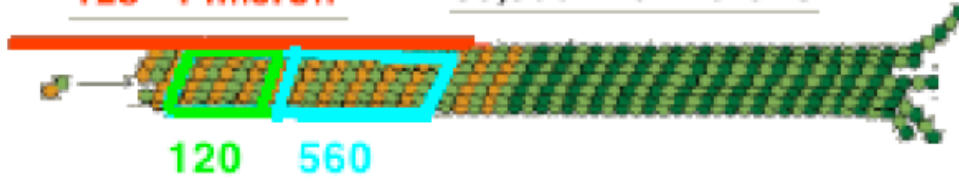

(image adapted from 12biophys.blogspot.com Lecture 11)
and so

can have Bohm Quantum Resonance with Cl(16) Spacetime cells

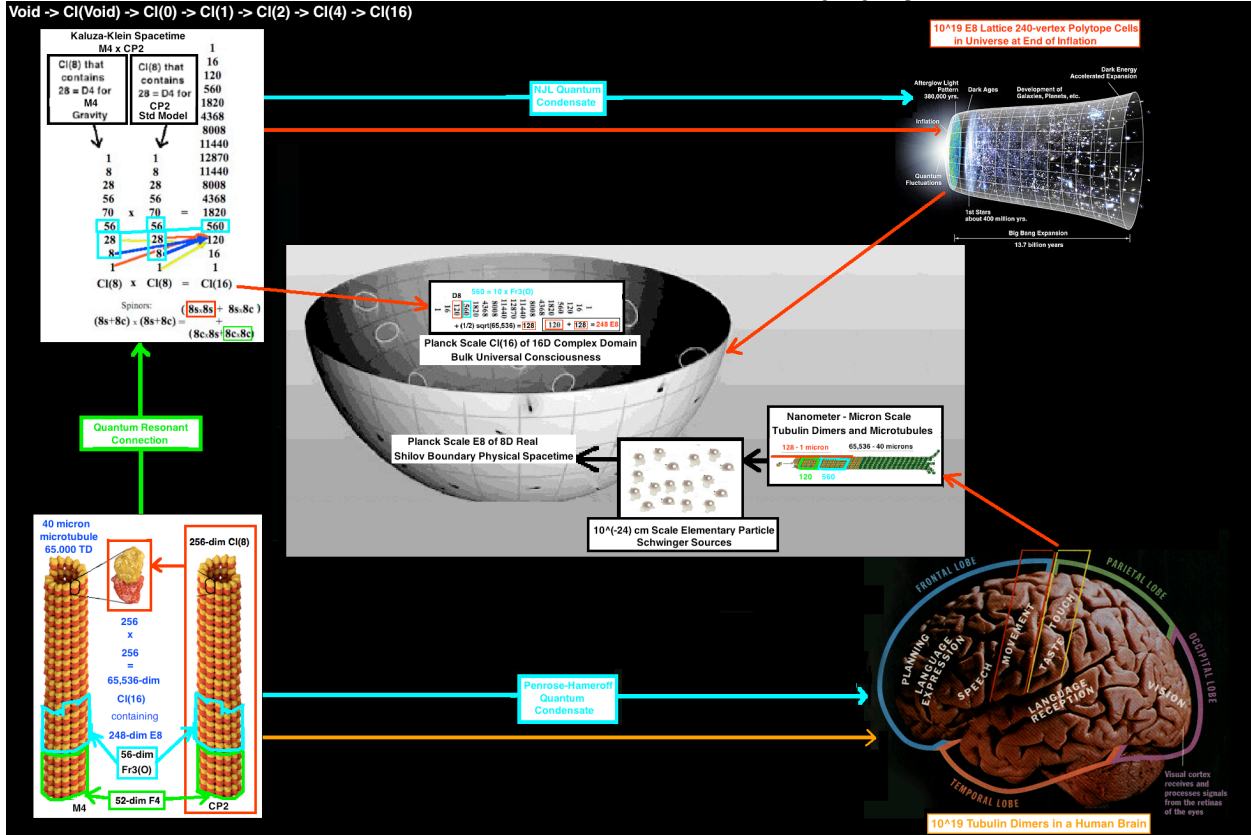

so that at any and all Times
the State of Consciousness of a Human
is in exact resonant correspondence with
a subset of the cells of E8 Classical Lagrangian Spacetime

Therefore

E8 Classical Lagrangian Spacetime NJL Condensate is effectively the **Spirit World** in which the **Human States of Consciousness = Souls** exist. After the death of the Human Physical Body the Spirit World interactions with its Soul are no longer constrained by Physical World interactions with its Body so that the Spirit World can harmonize the individual Soul with the collective Universal Soul. **William Kingdon Clifford**, who invented **Real Clifford Algebras**, called them “mind-stuff”, saying: “...

When matter takes the complex form of a living human brain, the corresponding mind-stuff takes the form of a human consciousness ...”

CI(1,25) Algebraic Quantum Field Theory (AQFT)

26D String Theory has a Real Clifford Algebra $CI(1,25)$ constructed from

$CI(16) = CI(8) \times CI(8) \rightarrow CI(8) \times CI(8) \times CI(8) = CI(24)$
to get to the Leech Lattice 24-dim Vector Space

Conformal Structure of 2×2 matrices with entries in $CI(24)$
(Porteous, Clifford Algebras and the Classical Groups and
Lounesto and Porteous, Lectures on Clifford (Geometric) Algebras and Applications)
gives $M(2, CI(24)) = CI(1,25)$ with Lorentz Leech Lattice Vector Space.

Since all the matrix entries are tensor product of 3 copies of $CI(0,8)$
8-Periodicity allows formation of the tensor products of copies of $CI(1,25)$

$$CI(1,25) \times \dots (N \text{ times tensor product}) \dots \times CI(1,25)$$

For $N = 2^8 = 256$ the copies of $CI(1,25)$ are on the 256 vertices
of the 8-dim HyperCube



For $N = 2^{16} = 65,536$ the copies of $CI(1,25)$ fill in the 8-dim HyperCube
William Gilbert's web page says: "... The n-bit reflected binary [Gray](#) code
will describe a path on the edges of an n-dimensional cube that can be
used as the initial stage of a Hilbert curve that will fill an n-dim... cube. ...".

As N grows, the copies of $CI(1,25)$ continue to fill the 8-dim HyperCube of
 E_8 SpaceTime using higher Hilbert curve stages from the 8-bit reflected
binary Gray code subdividing the initial 8-dim HyperCube into more and
more sub-HyperCubes. If edges of sub-HyperCubes, equal to the distance
between adjacent copies of $CI(1,25)$, remain constantly at the Planck

Length, then the full 8-dim HyperCube of our Universe expands as N grows to 2^{16} and beyond similarly to the way shown by this 3-HyperCube example for $N = 2^3, 4^3, 8^3$ from William Gilbert's web page:

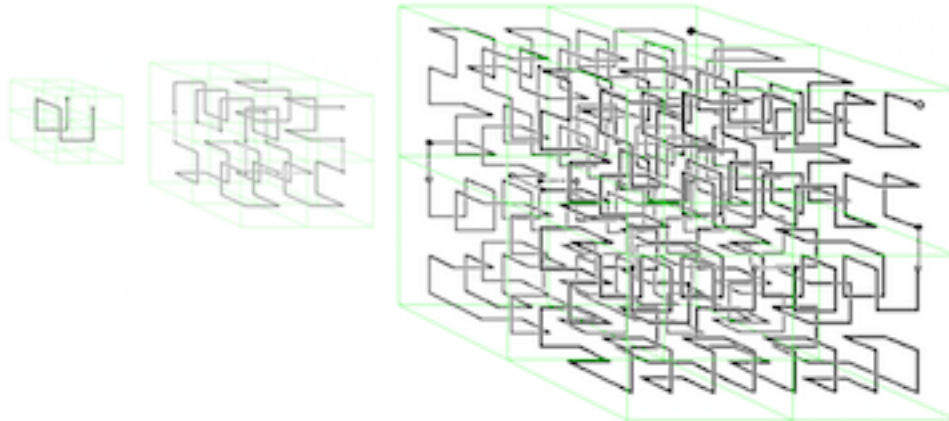

**Completion of Union of All Tensor Products of $Cl(1,25) =$
 $=$ hyperfinite AQFT = Algebraic Quantum Field Theory =
 $=$ the Third Grothendieck Universe**

The AQFT contains a copy of E_8 within $Cl(16)$ within each copy of $Cl(1,25)$

**The E_8 is a Recipe for a Realistic Physics Lagrangian
so the AQFT has a natural realistic Lagrangian structure.**

The Vector Space of $Cl(1,25)$ is the Spacetime of a 26D String Theory
in which Strings are World-Lines of Particles

and

**the Massless Symmetric Spin 2 State is the Carrier
of the Bohm Quantum Potential with Sarfatti Back-Reaction**

The **$Cl(1,25)$ AQFT** being the completion of the union of all tensor products of $Cl(1,25)$

it is the Real Clifford Algebra (8-Periodicity) analog

of the completion of the union of all tensor products of the Complex Clifford Algebra
(2-Periodicity) $Cl(2;C)$ of 2×2 Complex Matrices = $M_2(C)$ of Spinor Fock Space that

is the **Hyperfinite II₁ von Neumann factor algebra.**

AQFT Quantum Code

Cerf and Adami in quantum-ph/9512022 describe virtual qubit-anti-qubit pairs (they call them ebit-anti-ebitpairs) that are related to negative conditional entropies for quantum entangled systems and are similar to fermion particle-antiparticle pairs. Therefore quantum information processes can be described by particle-antiparticle diagrams much like particle physics diagrams and

the Algebraic Quantum Field Theory of the CI(1,25) E8 Physics Model should have a Quantum Code Information System

that is **based on structure of a unit cell in 26D String Theory**
 represented by **Real Clifford Algebra CI(0,8) x CI(0,8) x CI(0,8) = CI(0,24)**
 (see Appendix - Details of World-Line String Bohm Quantum Theory)

Since Quantum Reed-Muller code [[256 , 0 , 24]]
 corresponds to
Real Clifford Algebra CI(0,8)

Tensor Product Quantum Reed-Muller code
[[256 , 0 , 24]] x **[[256 , 0 , 24]]** x **[[256 , 0 , 24]]**
 corresponds to

AQFT (Algebraic Quantum Field Theory) hyperfinite von Neumann factor algebra
that is Completion of the Union of All Tensor Products of CI(1,25)

Quantum Reed-Muller code [[256 , 0 , 24]]

is described in quantum-ph/9608026 by Steane as mapping a quantum state space of 256 qubits into 256 qubits, correcting $((24-1)/2) = 11$ errors, and detecting $24/2 = 12$ errors.

Let $C(n,t) = n! / t! (n-t)!$

Then

[[256, 0, 24]]

is of the form

[[2 ⁿ ,	2 ⁿ - C(n,t) - 2 SUM(0 k t-1) C(n,k),	2 ^t + 2 ^(t-1)]]
[[2 ⁸ ,	2 ⁸ - C(8,4) - 2 SUM(0 k 3) C(8,k),	2 ⁴ + 2 ⁽⁴⁻¹⁾]]
[[2 ⁸ ,	2 ⁸ - 70 - (1+8+28+56) - (1+8+28+56),	16 + 8]]
[[256,	256 - (1+8+28+56+70+56+28+8+1),	16 + 8]]
[[256,	16x16 - SUM(0 k 8) 8/\8/\...(k)../\8,	16 + 8]]

The quantum code [[256, 0, 24]]

can be constructed from the classical Reed-Muller code (256, 93, 32) of the form

(2 ⁸ ,	2 ⁸ - SUM(0 k t) C(n,k),	2 ^(t+1))
(2 ⁸ ,	2 ⁸ - SUM(0 k 4) C(n,k),	2 ⁵)
(2 ⁸ ,	2 ⁸ - (70+56+28+8+1),	32)
(2 ⁸ ,	1+8+28+56,	32)

To construct the quantum code $[[256, 0, 24]]$:

First, form a quantum code generator matrix from the 128×256 generator matrix G of the classical code $(256, 93, 32)$:

$$\begin{array}{c|c|c} & G & 0 \\ \hline & 0 & G \\ \hline \end{array}$$

Second, form the generator matrix of a quantum code of distance 16 by adding to the quantum generator matrix a matrix D_x such that G and D_x together generate the classical Reed-Muller code $(256, 163, 16)$:

$(2^8, 1+8+28+56+70, 16)$:

$$\begin{array}{c|c|c} & G & 0 \\ \hline & 0 & G \\ \hline & D_x & 0 \\ \hline \end{array}$$

This quantum code has been made by combining the classical codes $(256, 93, 32)$ and $(256, 163, 16)$, so that it is of the form $[[256, 93 + 163 - 256, \min(32, 16)]] = [[256, 0, 16]]$.

It is close to what we want, but has distance 16. For the third and final step, increase the distance to $16+8 = 24$ by adding D_z to the quantum generator matrix:

$$\begin{array}{c|c|c} & G & 0 \\ \hline & 0 & G \\ \hline & D_x & D_z \\ \hline \end{array}$$

This is the generator matrix of the quantum code $[[256, 0, 24]]$ as constructed by Steane.

The two classical Reed-Muller codes used to build $[[256, 0, 24]]$ are $(256, 163, 32)$ and $(256, 93, 16)$, classical Reed-Muller codes of orders 4 and 3, which are dual to each other. Due to the nested structure of Reed-Muller codes, they contain the Reed-Muller codes of orders 2, 1, and 0 :

Classical Reed-Muller Codes of Length $2^8 = 256$				Order
(256,	$1+8+28+56+70+56+28+8+1,$	1)	8
(256,	$1+8+28+56+70+56+28+8,$	2)	7
(256,	$1+8+28+56+70+56+28,$	4)	6
(256,	$1+8+28+56+70+56,$	8)	5
(256,	$1+8+28+56+70,$	16)	4
(256,	$1+8+28+56,$	32)	3
(256,	$1+8+28,$	64)	2
(256,	$1+8,$	128)	1
(256,	1,	256)	0

In the Lagrangian of the $Cl(1,25)$ E8 Physics Model

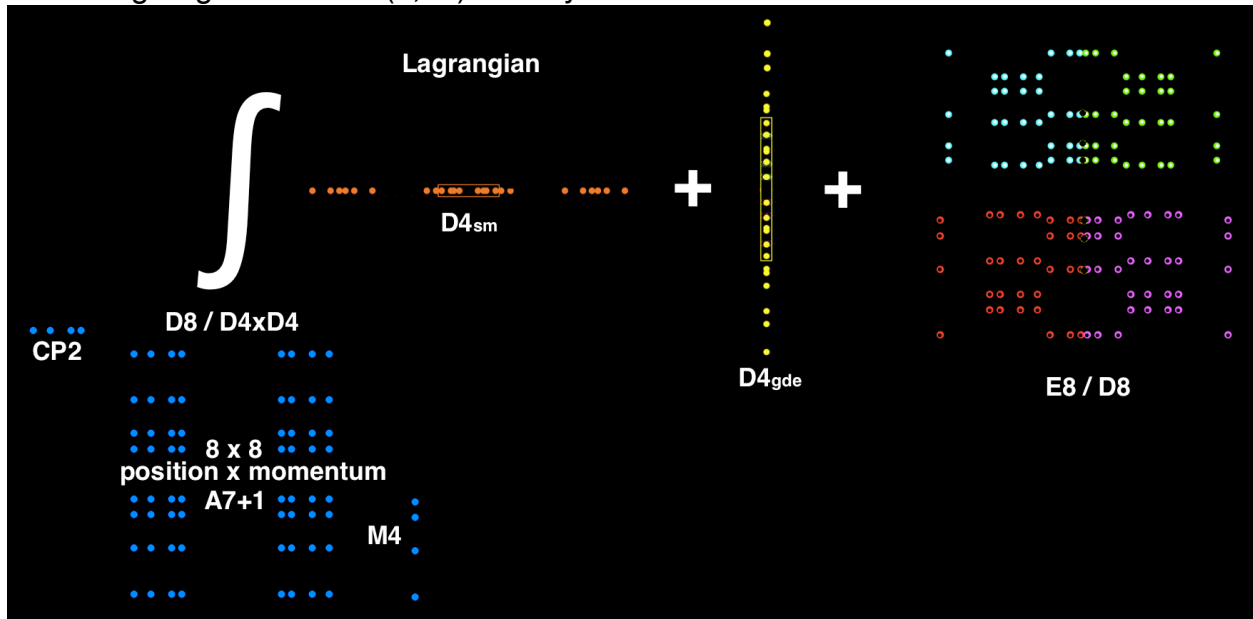

the Higgs scalar prior to dimensional reduction corresponds to the 0th order classical Reed-Muller code $(256, 1, 256)$, the classical repetition code;

the 8-dimensional vector spacetime

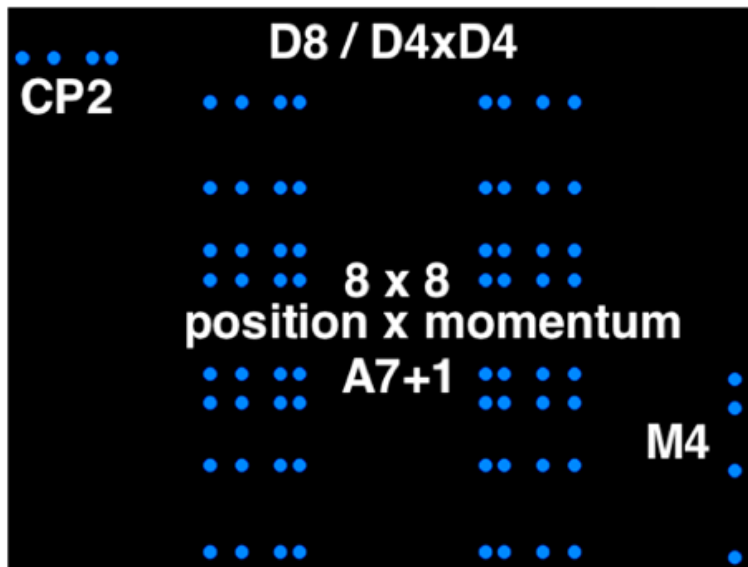

prior to dimensional reduction corresponds to non-0th-order part of the 1st order classical Reed-Muller code (256, 9, 128), which is dual to the 6th order classical Reed-Muller code (256, 247, 4), which is the extended Hamming code, extended from the binary Hamming code (255, 247, 3), which is dual to the simplex code (255, 8, 128) ;

the 28-dimensional bivector adjoint gauge boson spaces

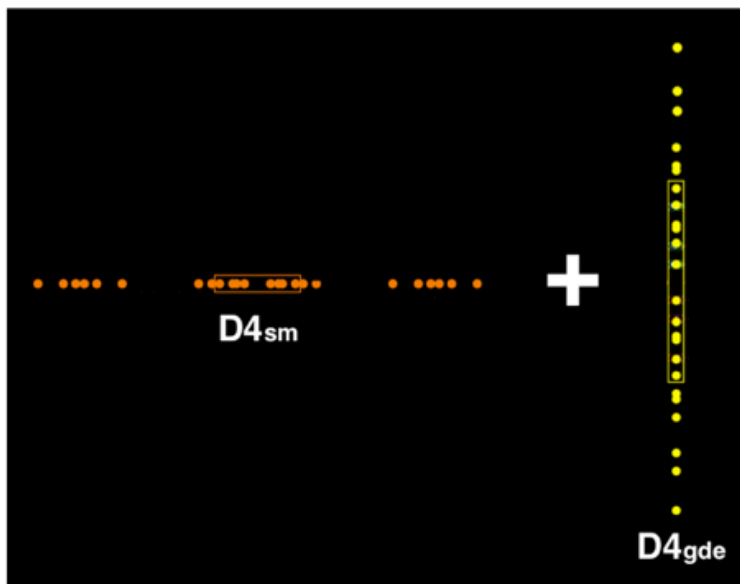

prior to dimensional reduction correspond to the non-1st-order part of the 2nd order classical Reed-Muller code (256, 37, 64) .

The 8 first generation fermion particles and 8 first generation fermion antiparticles of the 16-dim full spinor representation of the 256-dimensional $Cl(0,8)$ Clifford algebra

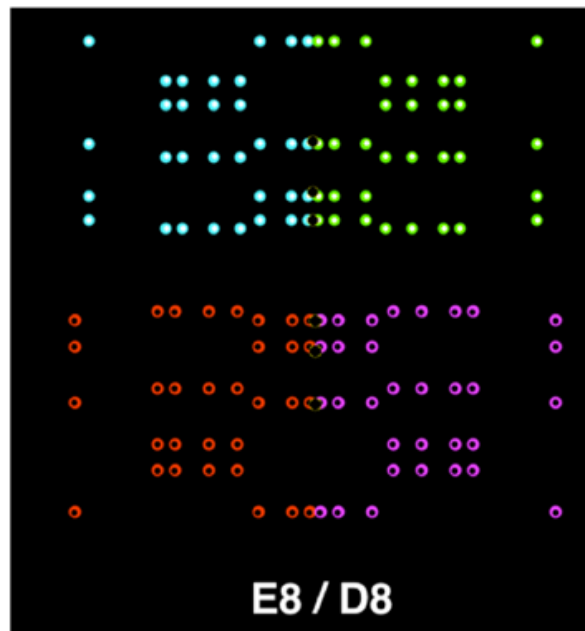

correspond to the distance of the classical Reed-Muller code (256, 93, 16), and to the 16-dimensional Barnes-Wall lattice Λ_{16} , which lattice comes from the (16,5,8) Reed-Muller code. Each Λ_{16} vertex has 4320 nearest neighbors.

The other 8 of the $16+8 = 24$ distance of the quantum Reed-Muller code $[[256, 0, 24]]$ corresponds to the 8-dimensional vector spacetime, and to the 8-dimensional E_8 lattice which comes from the (8,4,4) Hamming code, with weight distribution $0(1) 4(14) 8(1)$.

It can also be constructed from the repetition code (8,1,1). The dual of (8,1,1) is (8,7,2), a zero-sum even weight code, containing all binary vectors with an even number of 1s.

Each E_8 lattice vertex has 240 nearest neighbors. In Euclidean R_8 , there is only one way to arrange 240 spheres so that they all touch one sphere, and only one way to arrange 56 spheres so that they all touch a set of two spheres in contact with each other, and so forth, giving the following classical spherical codes:

(8,240,1/2), (7,56,1/3), (6,27,1/4), (5,16,1/5), (4,10,1/6), and (3,6,1/7).

(If you use an Octonion Integral Domain instead of Euclidean R_8 without multiplication then there are 7 algebraically independent ways to arrange the 240 spheres.)

The total 24 distance of the quantum Reed-Muller code $[[256, 0, 24]]$

corresponds to the 24-dimensional Leech lattice,

and to the classical extended Golay code (24, 12, 8)

in which lattice each vertex has 196,560 nearest neighbors. In Euclidean R_{24} , there is only one way to arrange 196,560 spheres so that they all touch one sphere, and only one way to arrange 4600 spheres so that they all touch a set of two spheres in contact with each other, and so forth, giving the following classical spherical codes:

(24,196560,1/2), (23,4600,1/3), (22,891,1/4), (21,336,1/5), (20,170,1/6),

Results of E8 Physics Calculations:

Here is a summary of E8 Physics model calculation results. Since ratios are calculated, values for one particle mass and one force strength are assumed. Quark masses are constituent masses. Most of the calculations are tree-level, so more detailed calculations might be even closer to observations.

Fermions as Schwinger Sources have geometry of Complex Bounded Domains with Kerr-Newman Black Hole structure size about $10^{(-24)}$ cm.

(for calculation details see viXra 1804.0121)

Dark Energy : Dark Matter : Ordinary Matter = 0.75 : 0.21 : 0.04

Particle/Force	Tree-Level	Higher-Order
e-neutrino	0	0 for nu ₁
mu-neutrino	0	9 x 10 ⁽⁻³⁾ eV for nu ₂
tau-neutrino	0	5.4 x 10 ⁽⁻²⁾ eV for nu ₃
electron	0.5110 MeV	
down quark	312.8 MeV	charged pion = 139 MeV
up quark	312.8 MeV	proton = 938.25 MeV
		neutron - proton = 1.1 MeV
muon	104.8 MeV	106.2 MeV
strange quark	625 MeV	
charm quark	2090 MeV	
tauon	1.88 GeV	
beauty quark	5.63 GeV	
truth quark (low state)	130 GeV	(middle state) 174 GeV (high state) 218 GeV
W+	80.326 GeV	
W-	80.326 GeV	
W0	98.379 GeV	Z0 = 91.862 GeV
Mplanck	1.217x10 ¹⁹ GeV	
Higgs VEV (assumed)	252.5 GeV	
Higgs (low state)	126 GeV	(middle state) 182 GeV (high state) 239 GeV
Gravity Gg (assumed)	1	
(Gg)(Mproton ² / Mplanck ²)		5 x 10 ⁽⁻³⁹⁾
EM fine structure	1/137.03608	
Weak Gw	0.2535	
Gw(Mproton ² / (Mw+ ² + Mw- ² + Mz0 ²))		1.05 x 10 ⁽⁻⁵⁾
Color Force at 0.245 GeV	0.6286	0.106 at 91 GeV

Kobayashi-Maskawa parameters for W+ and W- processes are:

	d	s	b
u	0.975	0.222	0.00249 -0.00388i
c	-0.222 -0.000161i	0.974 -0.0000365i	0.0423
t	0.00698 -0.00378i	-0.0418 -0.00086i	0.999

The phase angle d13 is taken to be 1 radian.

E8 Physics: Higgs and Truth Quark = 3-Mass-State Nambu-Jona-Lasinio System:

Higgs at 125 GeV and Truth Quark at 130 GeV

Higgs at 200 GeV and Truth Quark at 174 GeV

Higgs at 250 GeV and Truth Quark at 220 GeV

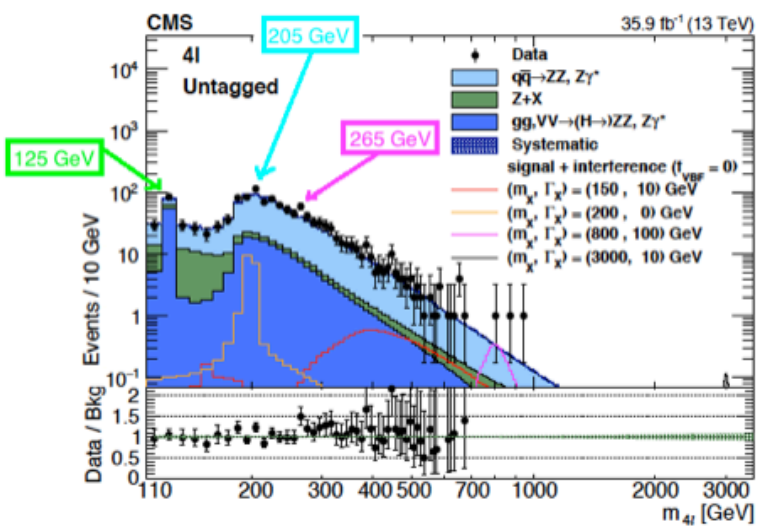
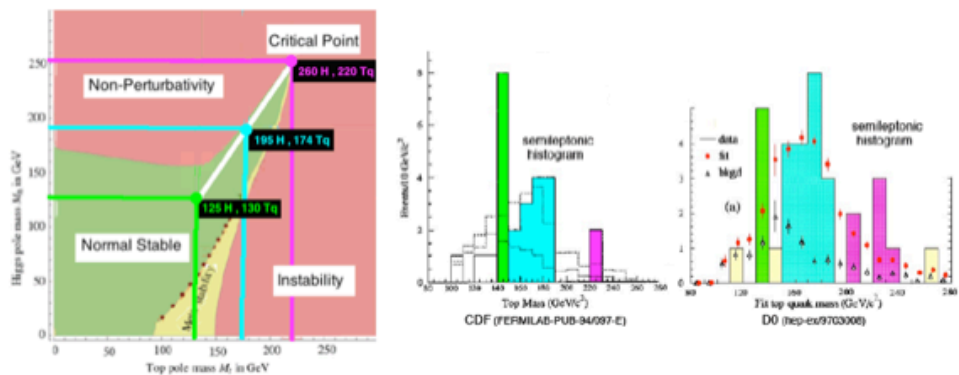

Upper Left = Higgs-Truth Quark mass state phase diagram

Upper Center = CDF semileptonic histogram of 3 Truth Quark Mass States
FERMILAB-PUB-94/097E

Upper Right = D0 semileptonic histogram of 3 Truth Quark Mass States
hep-ex/9703008

Lower = CMS H -> ZZ* -> 4l histogram of 3 Higgs Mass States
arXiv 1804.01939

Ancient History: Rig Veda / Angkor Wat - Giza Pyramids Sphinx - Cellular Automata

Rig Veda / Angkor Wat

About 50,000 years ago (National Geographic Genographic)
YAP and M174 went out of Africa to Sunda
(then dry land South of Angkor Wat
and SouthEast of India)
and on to Japan and Tibet



Angkor Wat = $4 \quad 2^4 = 16$ Angkor Thom = $16 \times 16 = 256 = \text{sqrt}(65,536)$
 Wat and Thom have 8-level ($2^8 = 256$) Central Towers
 Phnom Bakheng is 7-level Mt. Meru with 5 Top-level Sanctuaries

When M174 arrived at Angkor Wat they realized that they were far from Africa so, since they could not communicate easily with the African Elders about IFA, they decided to preserve knowledge of IFA in a written Language. To do that, they invented Sanskrit and wrote Earth's First Book, the Rig-Veda. According to Feuerstein, Kak, and Frawley in their book "In Search of the Cradle of Civilization" "... the Rig-Veda mentions a stellar configuration that corresponds to a date from 6000 B.C. to 7000 B.C. ..." which, due to the Precession of the Equinoxes cycle of about 26,000 years, would also occur from about 34,000 to 35,000 years ago, which is close to Manetho's date of 36,525 years ago for the beginning of the Rule of Gods.

Rig Veda encodes the 240 Root Vectors of E8 = 24+24+64+64+64

Ahankar	Buddhi	Manas	Akash	Vayu	Agni	Jal	Prithivi	Ahankar	Buddhi	Manas	Akash	Vayu	Agni	Jal	Prithivi	Ahankar	Buddhi	Manas	Akash	Vayu	Agni	Jal	Prithivi
अकृ	नि	मी	ळे	पु	रो	हि	तं	यु	ज्ञ	स्यं	दे	व	मू	त्वि	जंम	हो	ता	रं	रं	लु	धा	तं	मम्
AK	NI	MI	LE	PI	RO	HI	TAM	YA	GVA	SYA	DE	VA	MRI	TVI	JAM	HO	TA	RAM	RA	TNA	DHA	TA	MAM
अ	मिः	पू	वै	पिः	अ	वि	धि	री	ड	री	तु	तं	नै	तु	त	स	डे	चौ	ए	ह	वै	च	ति
अ	मिः	नो	रु	पिः	मं	वन	व	लो	ध	मे	व	दि	वे	दि	वे	यु	श	सै	खी	र	व	त	मम्
अ	मिः	यो	यु	ज्ञ	मं	ध्व	रं	वि	क्ष	तं	प	पि	धु	रं	मिः	स	इ	इ	डे	के	ग	च्छ	ति
अ	मिः	हो	वां	क	वि	कं	रुः	सु	त्यश्	त्रि	त्र	त्रं	व	स्त	मः	डे	वो	डे	वे	पि	रा	नं	मत्
य	द	ङ्	दा	शु	षे	व	व	अ	मे	म	त्र	क	रि	व्य	सिः	त	वेत्	तत्	सु	त्य	चं	ङ्गि	रः
उ	धं	त्वा	प्रे	दि	वे	दि	वे	दो	धां	व	स्तर	धि	या	वु	यम्	न	मो	म	रं	तु	ए	मं	सि
रा	वं	न	म	ध्व	रा	शौ	मो	पा	मु	त	स्यु	दी	दि	वि	म	व	धै	मा	मुं	सु	वे	द	धं
स	नः	पि	ते	व	सु	न	वे	अ	मं	सु	धा	यु	नो	व	व	स	वं	सु	आ	नः	स्व	स्त	धं

24 First Richa Syllables + 24 First Richa Gaps = D4sm + D4gde (purple box)

8x8 = 64 Last-8 Syllables of Last 8 Lines = D8 / D4sm x D4gde (blue box)

8x8 = 64 First-8 Syllables of Last 8 Lines (green box)

and

8x8 = 64 Middle-8 Syllables of Last 8 Lines (red box)

give 128 = E8 / D8 = Fermion Particles and AntiParticles

According to **The Constitution of the Universe by Maharishi Mahesh Yogi**, printed in newspapers including The Sunday Times (15 March 1992), The Sunday Telegraph (15 March 1992) Financial Times (16 March 1992), The Guardian (16 March 1992), The Wall Street Journal (6 January 1992), and The Washington Post (9 January 1992), a copy of which was sent to me in pamphlet form by John Small in August 2003:

"... modern science has systematically revealed deeper layers of order in nature, from the atomic to the nuclear and subnuclear levels of nature's functioning ...

... the ancient Vedic wisdom ... identifies a single, universal source of all orderliness in nature ...

Both understandings, modern and ancient, locate the unified source of nature's perfect order in a single, self-interacting field of intelligence at the foundation of all the laws of nature. ... The self-interacting dynamics of this unified field constitutes the most basic level of nature's dynamics ... The laws governing the self-interacting dynamics of the unified field can therefore be called the **Constitution of the Universe** ... In Maharishi's Vedic Science, ... the Constitution of the Universe ... is embodied in the very structure of the sounds of the Rik Ved, the most fundamental aspect of the Vedic literature ... According to Maharishi's Apaurusheya Bhashya, the structure of the Ved provides its own commentary - a commentary which is contained in the sequential unfoldment of the Ved itself in its various stages of expression. The knowledge of the total Ved ... is contained in the first sukt of the Rik Ved ...

... The precise sequence of sounds is highly significant; it is in the sequential progression of sound and silence that the true meaning and content of the Ved reside - not on the level of intellectual meanings ascribed to the Ved in the various translations.

The complete knowledge of the Ved contained in the first sukt (stanza) is also found in the first richa (verse) - the first twenty-four syllables of the first sukt (stanza 1). This complete knowledge is again contained in the first pad, or first eight syllables of the first richa, and is also found in the first syllable of the Ved, 'AK', which contains the total dynamics of consciousness knowing itself.

According to Maharishi's Apaurusheya Bhashya of the Ved,

- 'AK' describes the collapse of the fullness of consciousness (A) within itself to its own point value (K). This collapse, which represents the eternal dynamics of consciousness knowing itself, occurs in eight successive stages.
- In the next stage of unfoldment of the Ved, these eight stages of collapse are separately elaborated in the eight syllables of the first pad, which emerges from, and provides a further commentary on, the first syllable of Rik Ved, 'AK'. These eight syllables correspond to the eight 'Prakritis' (Ahamkar, etc.) or eight fundamental qualities of intelligence ...
- The first line, or 'richa', of the first sukt, comprising 24 syllables, provides a further commentary on the first pad (phrase of eight syllables);
 - The first pad expresses the eight Prakritis ... with respect to the knower ... observer ... or 'Rishi' quality of pure consciousness.
 - The second pad expresses the eight Prakritis with respect to the process of knowing ... process of observation ... of 'Devata' (dynamism) quality of pure consciousness.
 - The third pad expresses the eight Prakritis with respect to the known ... observed ... or 'Chhandas' quality of pure consciousness. ... [compare the 3 pads with [Triality](#)]
- The subsequent eight lines complete the remainder of the first sukt - the next stage of sequential unfoldment of knowledge in the Ved. These eight lines consist of 24 padas (phrases), comprising $8 \times 24 = 192$ syllables. ... these 24 padas of eight syllables elaborate the unmanifest, eight-fold structure of the 24 gaps between the syllables of the first richa (verse). ... Ultimately, in the subsequent stages of unfoldment, these 192 syllables of the first sukt (stanza) get elaborated in the 192 suktas that comprise the first mandal (circular cyclical eternal structure) of the Rik Ved, which in turn gives rise to the rest of the Ved and the entire Vedic literature. ...".

Note that

- the first richa of the first sukt has 24 syllables plus 24 gaps (if you include a silent gap at the beginning/end to close the first sukt into a circle) and
- those 24 gaps are made relevant by being elaborated by the following 8 richas of the first sukt, which have 192 syllables

so that **the total number of relevant entities in the first sukt is $24+24+192 = 240$** , which is the number of vertices of **the root vector polytope of E8**.

Giza Pyramids Sphinx

36,000 Years Ago - National Geographic Genographic YDNA -
M168 - YAP - M96 - **M35 Humans follow North Star Vega**
up the Nile to Giza and Mediterranean



This coincided with the beginning of Egyptian History according to Manetho (working under Alexander's General and successor Ptolemy I):
36,525 years ago - Rule of Gods - North Star Vega - Geminga Shock - Glaciation
22,625 years ago - Rule of Demigods - last Glacial Maximum
17,413 years ago - Rule of Spirits of the Dead - end of last Glacial Maximum
11,600 years ago - Rule of Mortal Humans - North Star Vega - Vela X - end of Ice Age

When Humans reached Giza they built two large Pyramids -
one for **F4gde (Gravity + Dark Energy)**
and one for **F4sm (Standard Model)** -
and the **Sphinx**

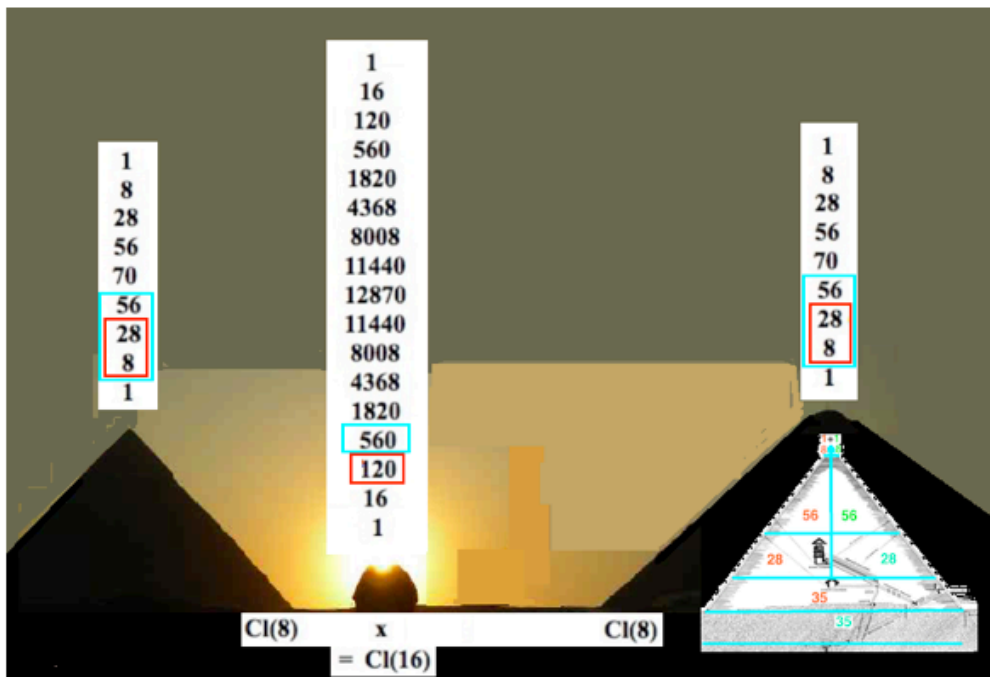

Each Pyramid represented a copy of $Cl(8)$ with graded structure

$$256 = 1 + 8 + 28 + 56 + 70 + 56 + 28 + 8 + 1 = (8L+8R) \times (8L+8R)$$

so that each contained a copy of 56-dim $Fr3(O)$

$$\text{and of } 52\text{-dim } F4 = 8 + 28 + (8L+8R)$$

By 8-Periodicity of Real Clifford Algebras the tensor product $Cl(8) \times Cl(8) = Cl(16)$

$Cl(16)$ contains 10 copies of $Fr3(O) = 1 \times 56 + 8 \times 28 + 28 \times 8 + 56 \times 1 = 560$ elements related to 26D World-Line=String Theory

$Cl(16)$ contains $(1 \times 28 + 8 \times 8 + 28 \times 1 = 120) + (8L \times 8L + 8R \times 8R = 128) = 248\text{-dim } E8$

248-dim $E8$ structure came from the $F4_{gde}$ and $F4_{sm}$ of the two Pyramids:

$$\text{tensor product } Cl(16) = Cl(8) \times Cl(8)$$

induces the product

$$E8 = F4_{gde} \times F4_{sm}$$

$$120\text{-dim } Cl(16) \text{ BiVectors} = 1 \times 28 + 8 \times 8 + 28 \times 1 \text{ of } Cl(8) \times Cl(8)$$

$$128\text{-dim } Cl(16) \text{ Half-Spinors} = 8L \times 8L + 8R \times 8R \text{ of } Cl(8) \times Cl(8)$$

where $8L$ denotes left-handed Half-Spinors of $Cl(8)$
and $8R$ denotes right-handed Half-Spinors of $Cl(8)$

and

$8L \times 8L + 8R \times 8R$ are the Half-Spinors of $Cl(16)$ with consistent handed-ness structure.

256-dim $Cl(8) \times 256$ -dim $Cl(8) = 65,536$ -dim $Cl(16)$ Clifford Algebra structure is also present in Microtubules = 40 micron size aggregates of 65,536 tubulin dimers that are the basis of Penrose-Hameroff Bohm Potential Quantum Consciousness.

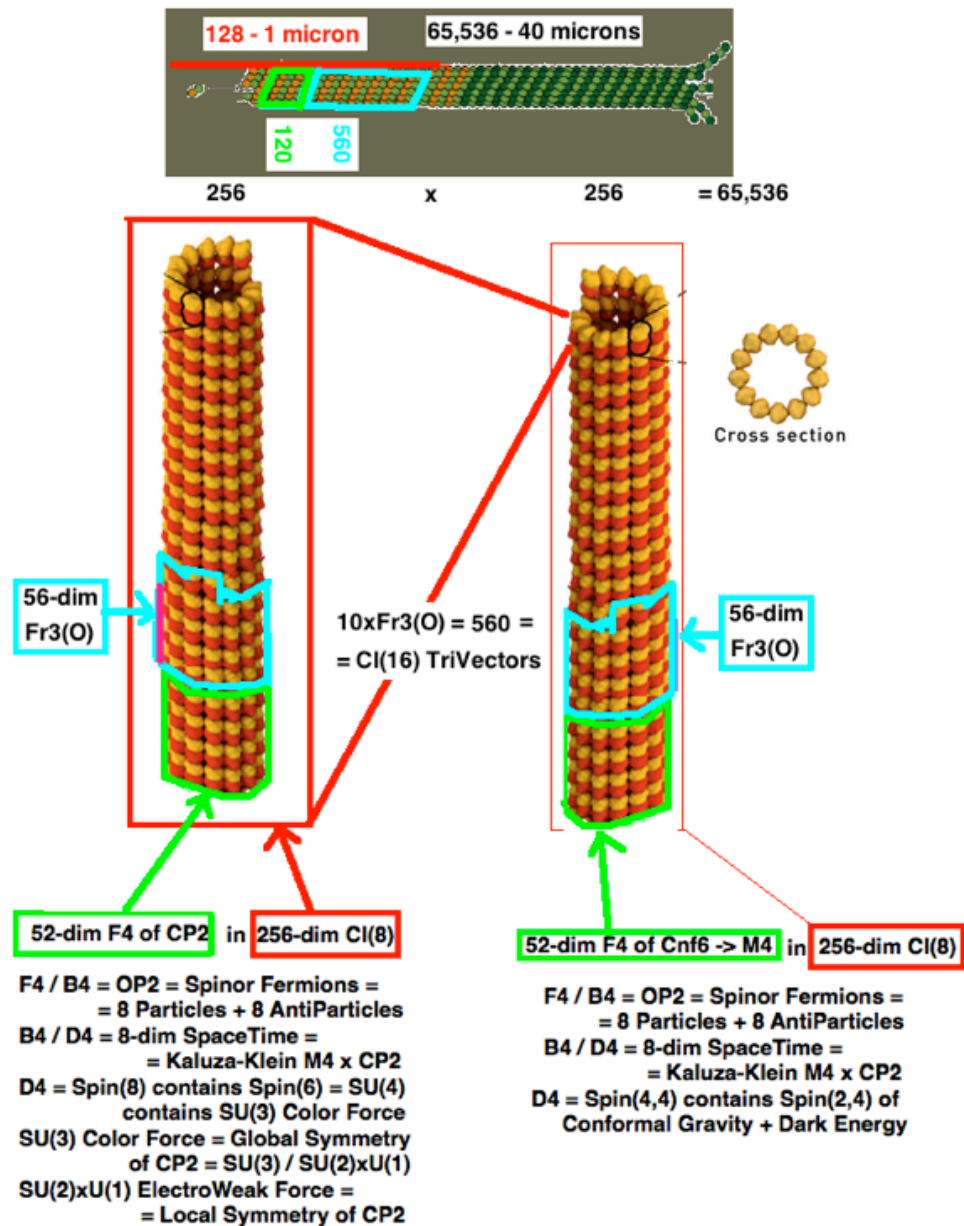

Assembly of 65,536 tubulins into a 40-micron microtubule can be seen to be analogous to the 256×256 tensor product $Cl(8) \times Cl(8)$ where one 256 -dim $Cl(8)$ represents Conformal Gravity+Dark Energy with $F4gde$ related to the Minkowski $M4$ of Kaluza-Klein $M4 \times CP2$ and the other $Cl(8)$ represents Standard Model $U(1) SU(2) SU(3)$ with $F4sm$ related to the $CP2 = SU(3) / SU(2) \times U(1)$ of Kaluza-Klein $M4 \times CP2$

The $E8$ and 10 copies of $Fr3(O)$ of $Cl(16)$ only use $248 + 560$ of the 65,536 elements so that 64,728 $Cl(16)$ elements are available for Quantum Consciousness thought processes

The Great Pyramid slope is of a Golden Ratio Right Triangle representing Conformal Gravity+Dark Energy with Gauge Group Spin(2,4) = SU(2,2)
 It represents M4 of Kaluza-Klein M4 x CP2 and is represented by F4gde

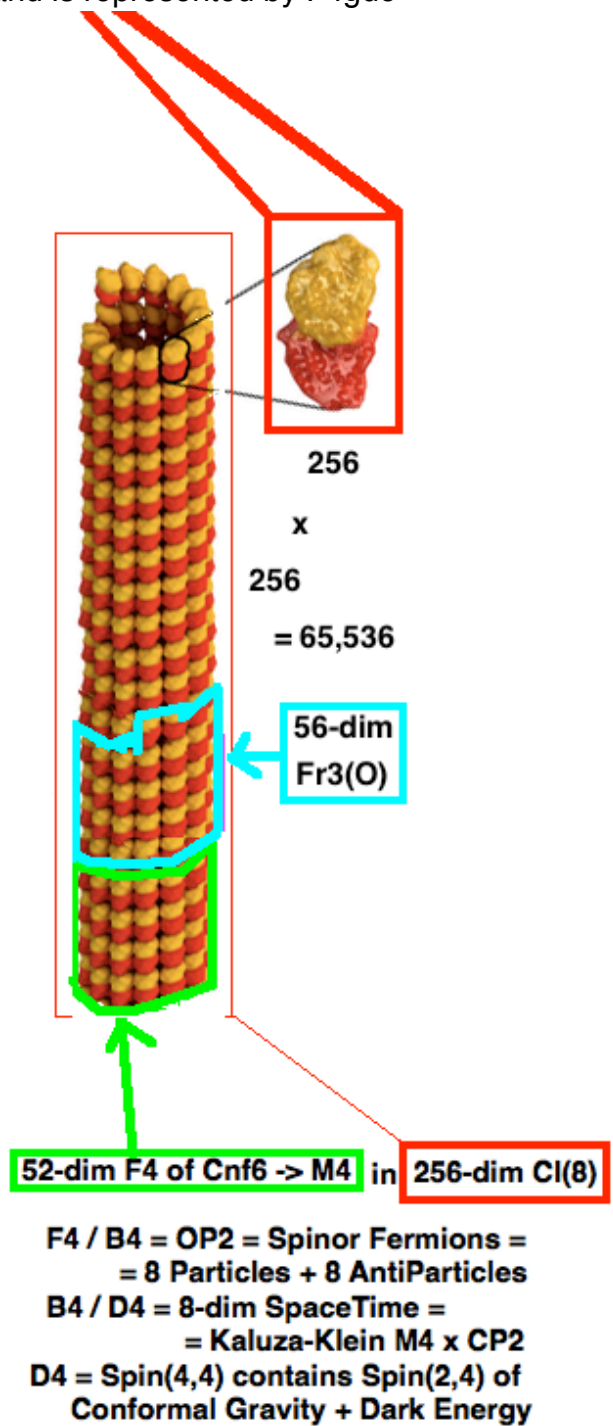
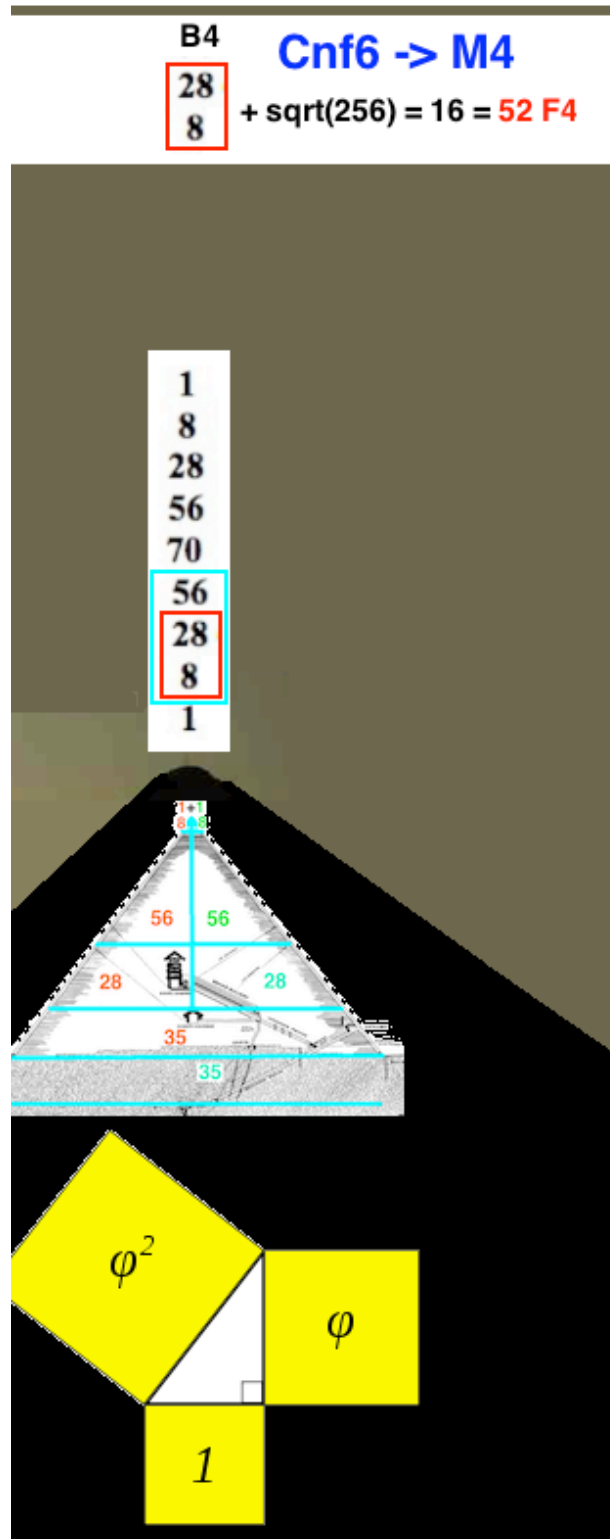

Clifford Algebras were not known to European mathematicians until Clifford in the 19th century and not known to European physicists until Dirac in the 20th century but it seems to me that their structure was known to Africans in ancient times. The courses of the Great Pyramid of Giza correspond to the graded structure of 256-dim $Cl(8)$:

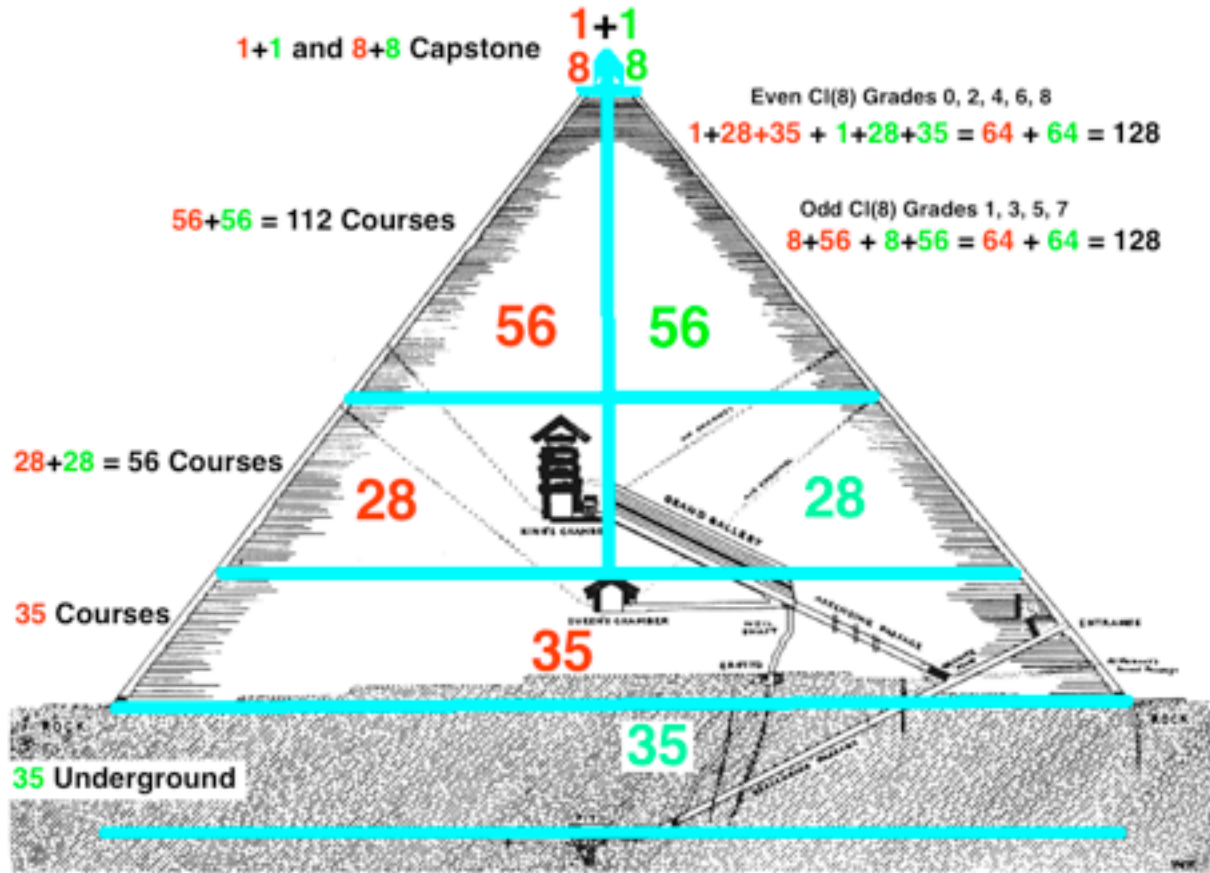

$$1 + 8 + 28 + 56 + (35 + 35) + 56 + 28 + 8 + 1$$

(image adapted from David Davidson image - for larger size see tony5m17h.net/GreatPyrCl8.png)
 Above the Grand Gallery is a Great Void leading to Ceiling Chambers above the Upper Chamber - (image from ScanPyramids web site)



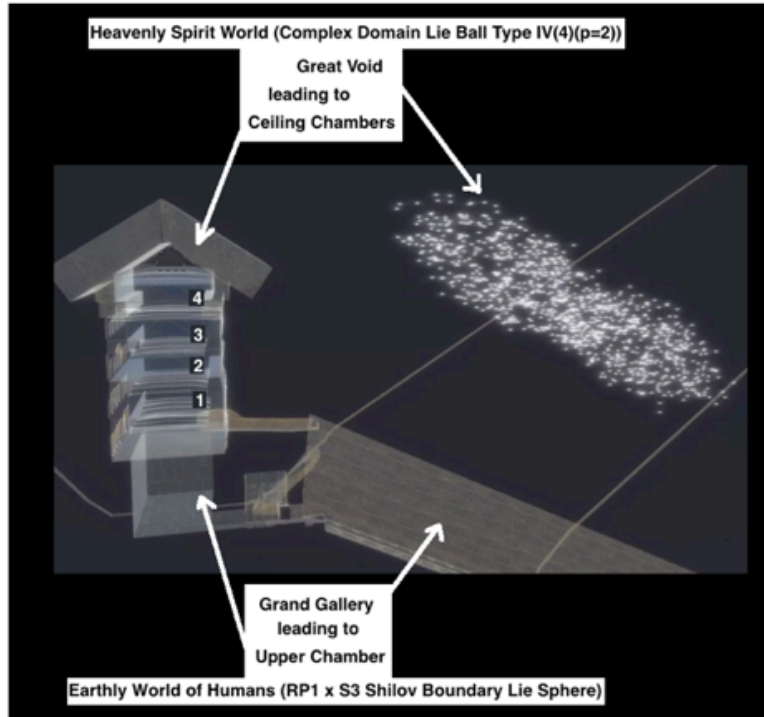

The Builders of the Great Pyramid represented the Real Shilov Boundary Physical world by the Grand Gallery and Upper Chamber that are easily accessible by Humans with Microtubule Quantum Consciousness and they represented the Imaginary Complex World of $Cl(16)$ Spacetime Cells mirroring the Human Microtubule World as Ceiling Chamber spaces and the Great Void that are more accessible to Souls of the Spirit World than to Physical Humans.

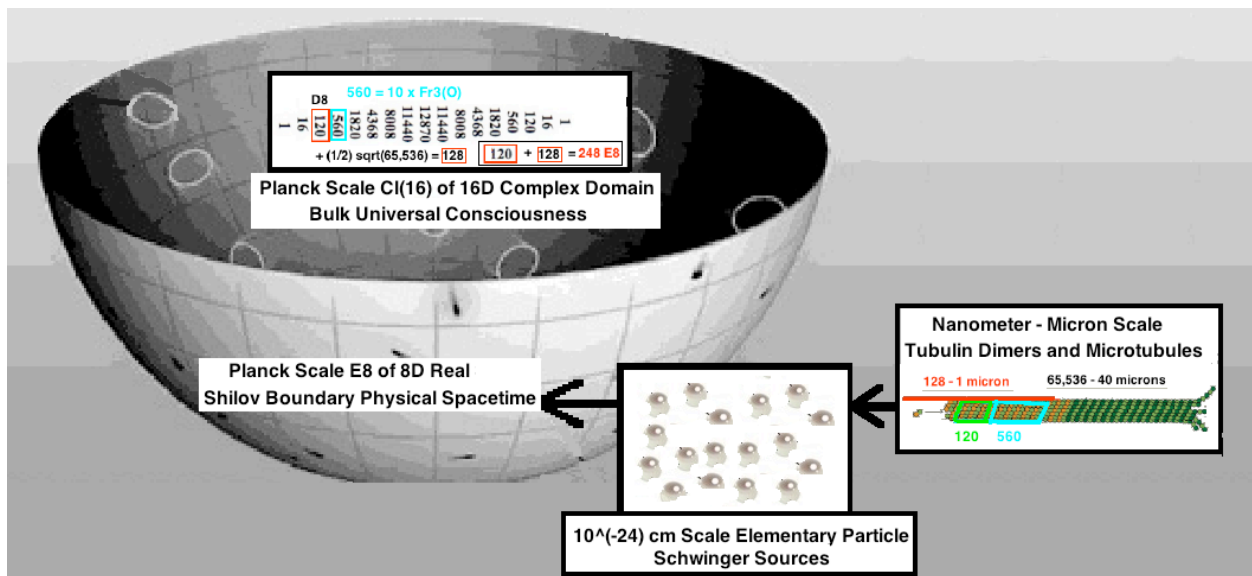

The Second Pyramid slope is of a 3-4-5 Right Triangle representing the Standard Model with Gauge Groups U(1) SU(2) SU(3) It represents CP2 of Kaluza-Klein M4 x CP2 and is represented by F4sm

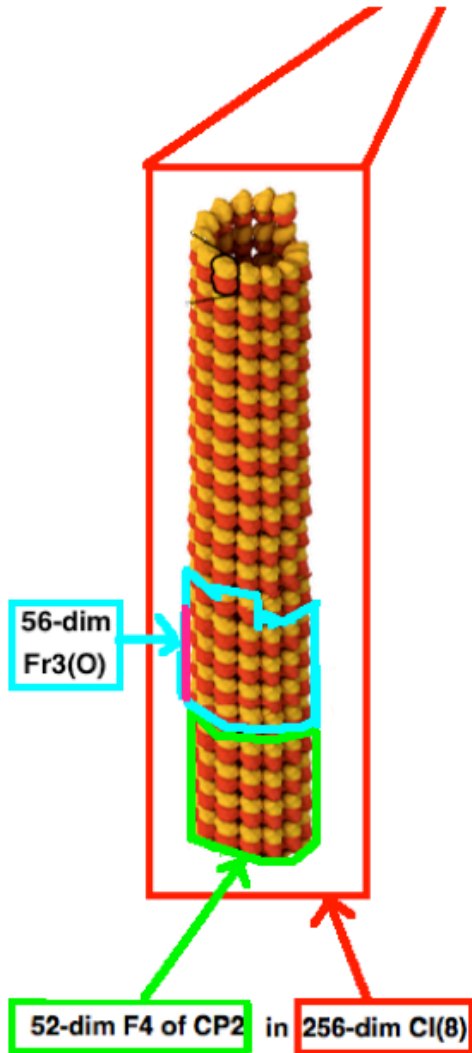

52-dim F4 of CP2 in 256-dim Cl(8)

F4 / B4 = OP2 = Spinor Fermions =
 = 8 Particles + 8 AntiParticles
 B4 / D4 = 8-dim SpaceTime =
 = Kaluza-Klein M4 x CP2
 D4 = Spin(8) contains Spin(6) = SU(4)
 contains SU(3) Color Force
 SU(3) Color Force = Global Symmetry
 of CP2 = SU(3) / SU(2)xU(1)
 SU(2)xU(1) ElectroWeak Force =
 = Local Symmetry of CP2

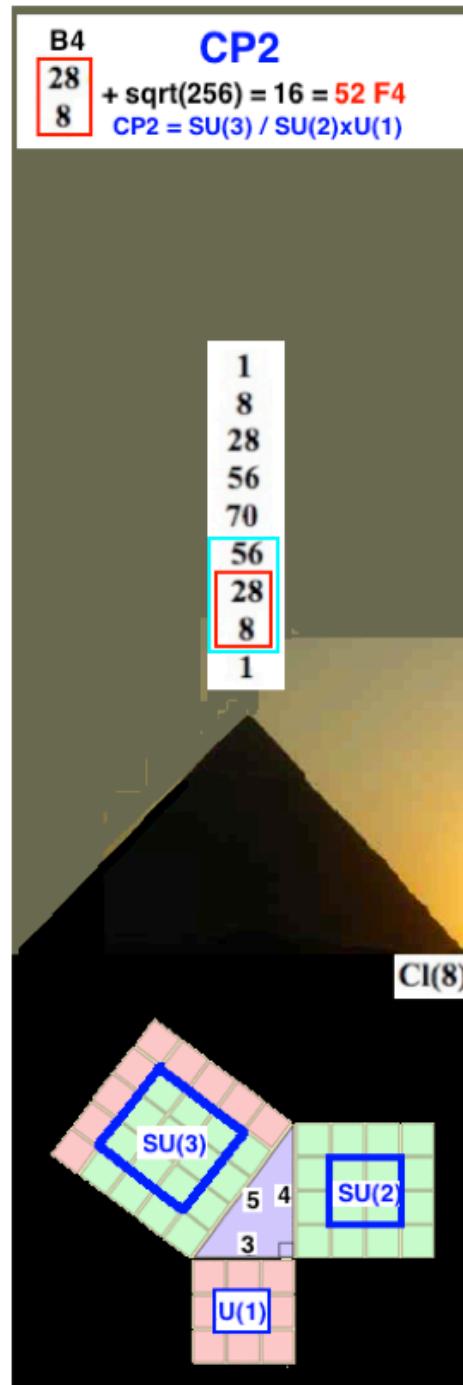

The Sphinx represents 65,536-dim $Cl(16)$ containing 248-dim E_8
as the tensor product combination of
the 256-dim $Cl(8)$ containing 52-dim F_4 related to CP^2 of $M_4 \times CP^2$
and the 256-dim $Cl(8)$ containing 52-dim F_4 related to M_4 of $M_4 \times CP^2$

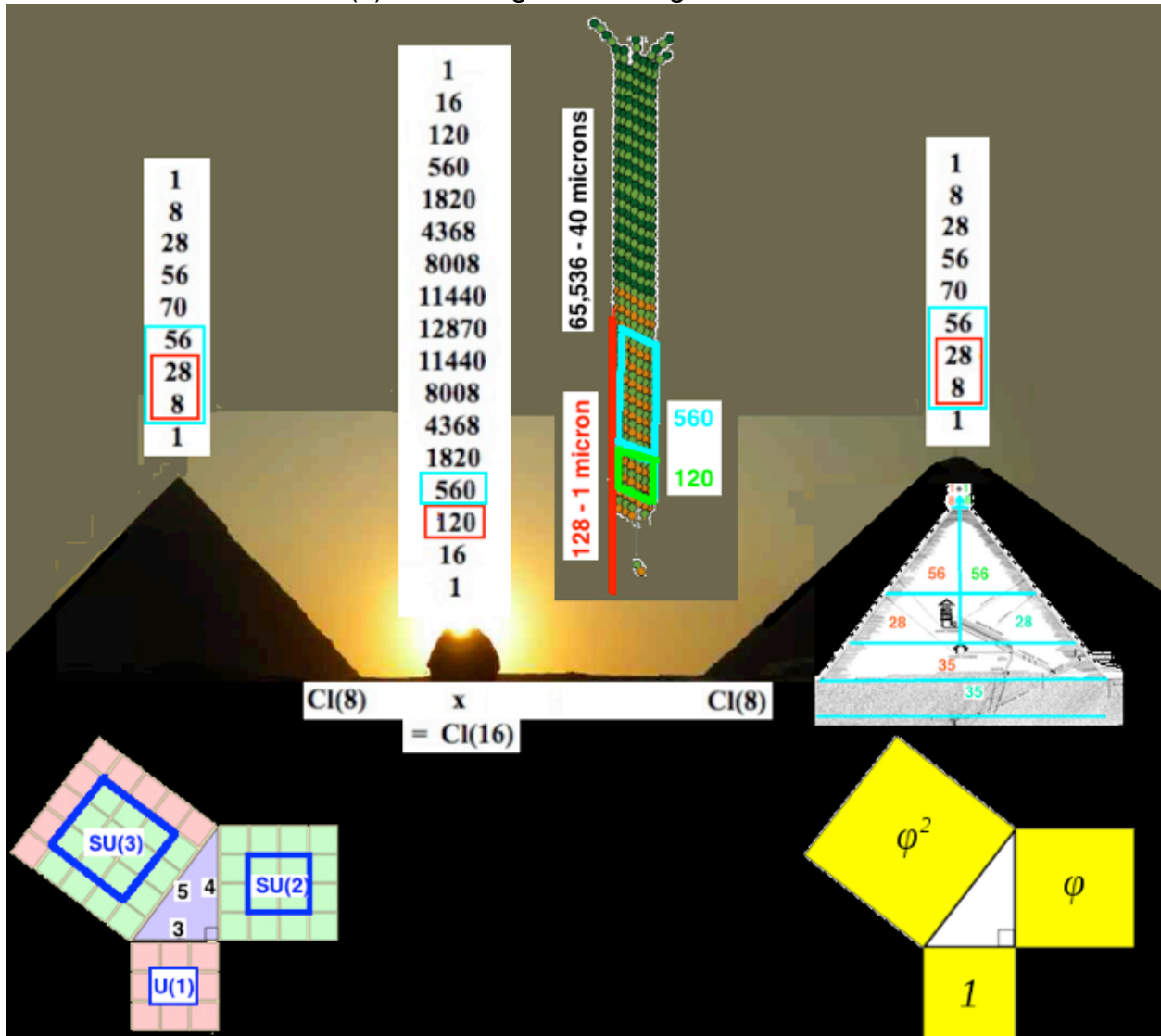

The image on the following page summarizes how the Sphinx represents
the $Cl(16)$ combination of the two large $Cl(8)$ Pyramids
and also
the 65,536-element 40 micron Microtubules of Bohm Quantum Consciousness

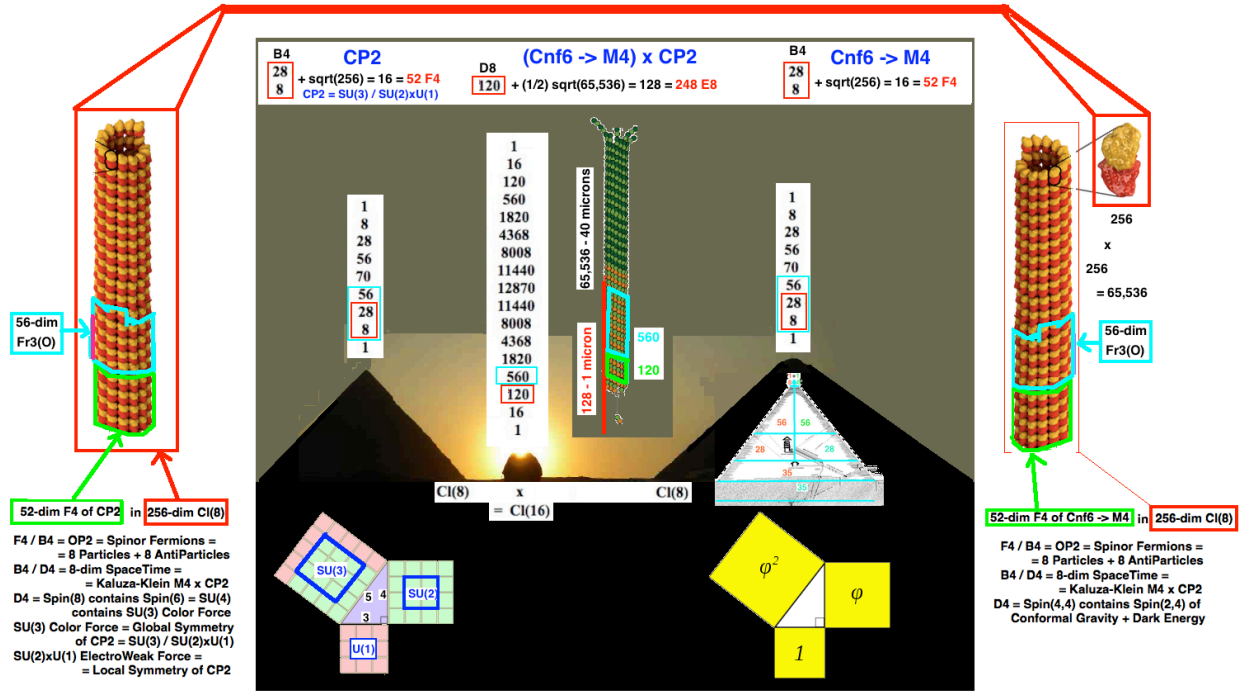

E8 Kaluza-Klein (Cnf6 -> M4) x CP2
 In $(C(8) \text{ of } CP2) \times (C(8) \text{ of } Cnf6 \rightarrow M4) = C(16)$ containing E8
 at each of the 256 points of $C(8)$ of $Cnf6 \rightarrow M4$ there are all 256 points of $C(8)$ of $CP2$
 $D8 = C(16)$ BiVectors = 120
E8 / D8 = 128-dim Fermion Spinor Space = 8 components of 8-8 Fermions
 $D8 / D4 \times D4 = A7+1 = 64 = 8\text{-dim position} \times 8\text{-dim momentum}$
 D4 containing $D3 = Spin(2,4) = A3 = SU(2,2)$ for Conformal Gravity + Dark Energy
 D4 containing $D3 = SU(4)$ containing Color Force SU(3)
 $10 \times Fr3(O) = C(16)$ TriVectors = 560

256 Elementary Cellular Automata = CI(8)

Terence McKenna said May 1993 OMNI magazine: "... From 75,000 to about 15,000 years ago, there was a ... human paradise on Earth ...

Entities there are ... teaching something.

Theirs is a higher dimensional language that condenses as a visible syntax ...

they ... offer you an object so beautiful, so intricately wrought, so something else that cannot be said in English ...

The object generates other objects ...

There are actual attractors ahead of us in time ...".

McKenna's Higher Dimensional Language = Real Clifford Algebras

as to which William Kingdon Clifford (1845 - 1879), according to Wikipedia - (1878, "On the Nature of Things-in-Themselves", Mind, Vol. 3, No. 9, pp. 57-67), said: re

"... That element of which ... even the simplest feeling is a complex, I shall call **Mind-stuff**.

A moving molecule of inorganic matter does not possess mind or consciousness ; but it possesses a small piece of mind-stuff. ...

When molecules are ... combined together ... **the elements of mind-stuff** which go along with them ... **combine ... to form the ... beginnings of Sentience**.

When the molecules are so combined as to form the brain and nervous system ... the corresponding elements of mind-stuff are so combined as to form some kind of consciousness ... changes in the complex which take place at the same time get so linked together that the repetition of one implies the repetition of the other.

When matter takes the complex form of a living human brain, the corresponding mind-stuff takes the form of a human consciousness ..."

8-Periodicity of Real Clifford Algebras shows that 256-dim CI(8) is the Basic Building Block of all Real Clifford Algebras and the CI(1,25) AQFT (Algebraic Quantum Field Theory) that is a Realistic Unified Model of Physics.

CI(8) structure is in African IFA divination through its $16 \times 16 = 2^8 = 256$ Odu and is also represented by the 256 Elementary Cellular Automata

the binary nature of which has its historical origin in Africa.

Ron Eglash (in his book "African Fractals" (Rutgers 1999) and on his web site) says: "... **a historical path for base-2 calculation ... begins with African divination ..."**

Raymond Aschheim (email May 2015) said, about **Cellular Automata (CA)**:

"... An elementary CA is defined by the next value (either 0 or 1) for a cell, depending on its ... value, and the ... value of it[s] left and of it[s] right neighbor cell (it is one dimensional, and involve only the first neighbors, and the cell itself) ... So the next value depends [on] 3 bits ... eight possible combination of three bits, and for each ... combination... the next value is either zero or one.

So the[re] are **256 ... CAs ..."**

Here is an overview of the structure of $Cl(8)$ and the 256 Elementary Cellular Automata:

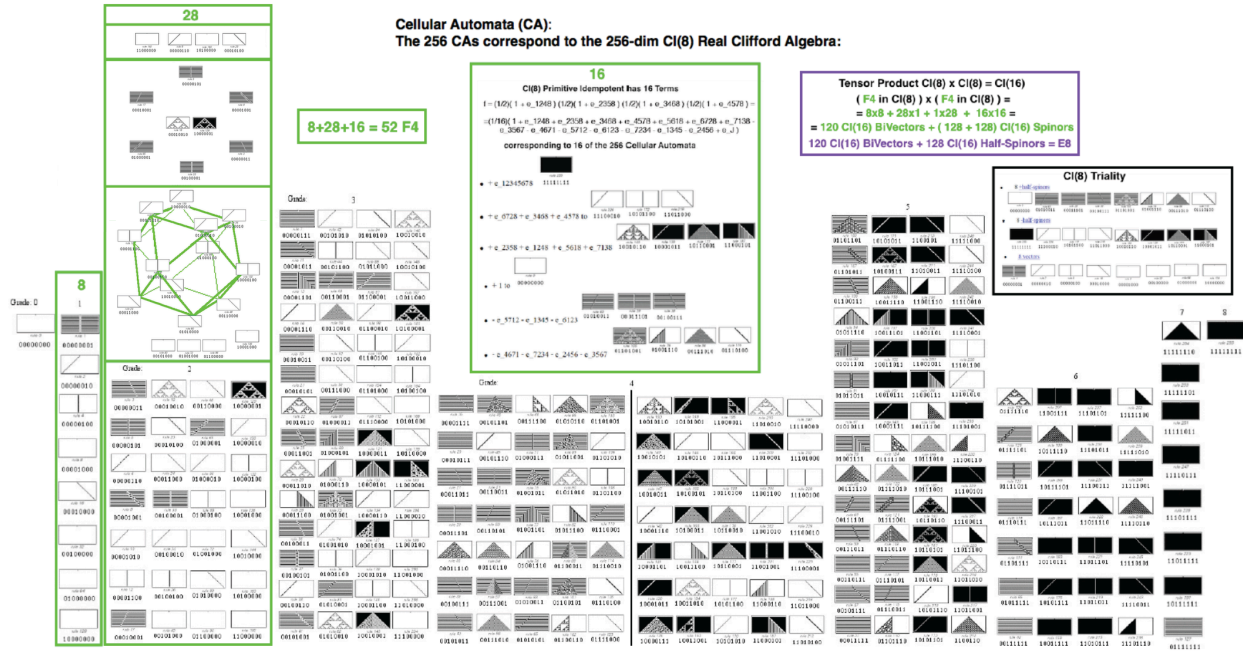

8 = Vectors
SpaceTime

$8+28+16 = 52 F_4$

16 = Spinors

(Nu, rDQ, gDQ, bDQ, bUQ, gUQ, rUQ, E)

(Nu, rDQ, gDQ, bDQ, bUQ, gUQ, rUQ, E)

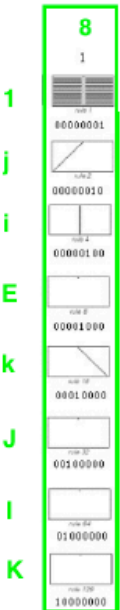

28 = D4 BiVectors

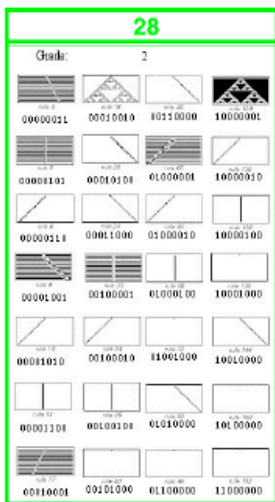

16

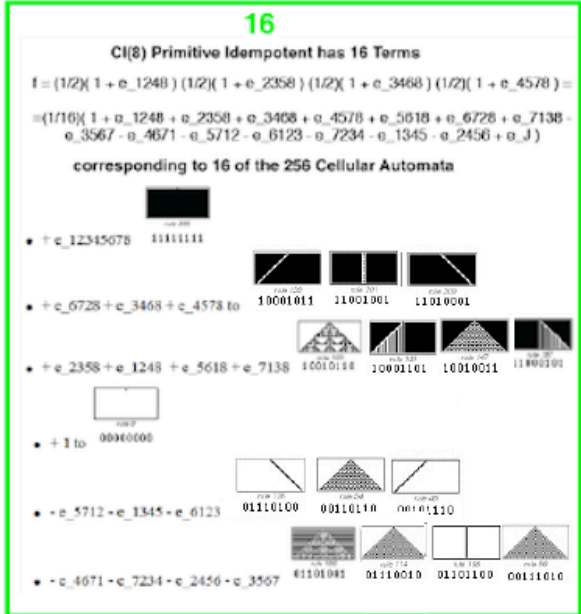

16 = 8L + 8R Spinors correspond to first-generation Fermions (8L left-handed Particles + 8R right-handed AntiParticles)

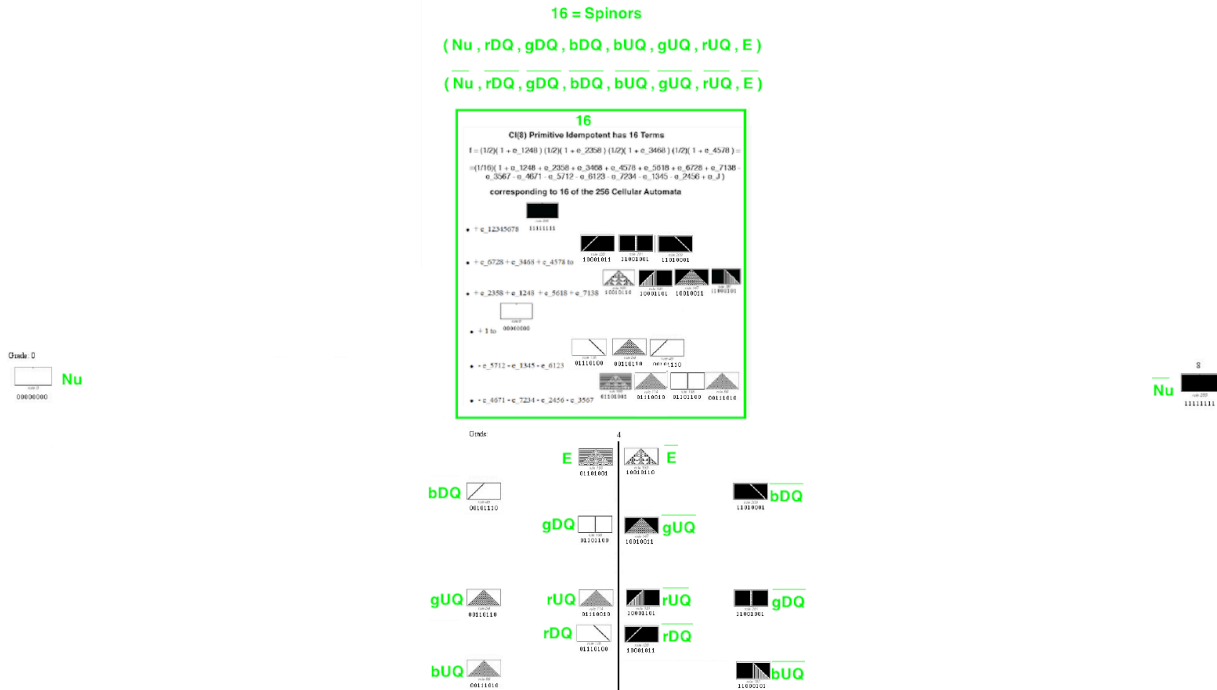

Pierre Ramond has shown in hep-th/0112261 that the Spinor part of F4 need not be written as Commutators but can also be written as Fermionic AntiCommutators so that **F4 Spinors can represent Physical Fermions**

There are two ways that 28 D4 BiVectors of Cl(8) can form Gauge Bosons and Ghosts so there are two ways that F4 can sit inside Cl(8) corresponding to the two Pyramids of Giza

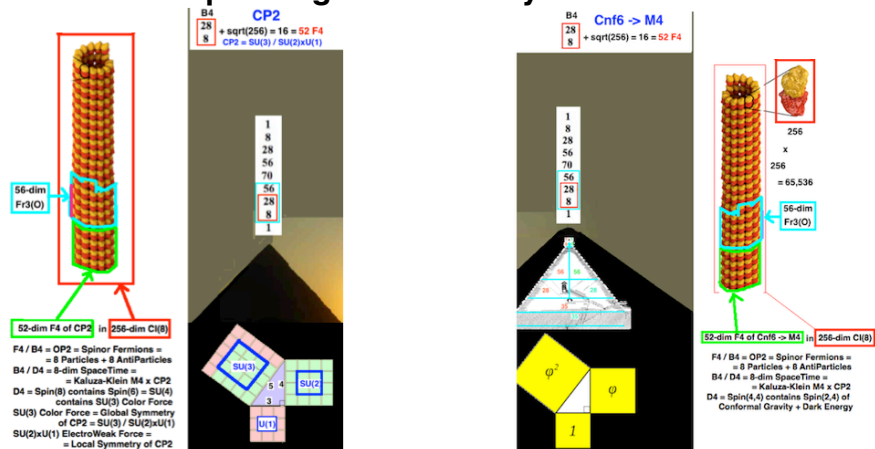

First - CP2 Standard Model
3-4-5 Pyramid

Second - M4 Gravity + Dark Energy
Golden Ratio Pyramid

1 -

**First D4 has 15-dim SU(4) subgroup
which has SU(3) as subgroup**

**CP2 = Internal Symmetry Space of Kaluza-Klein M4 x CP2
CP2 = SU(3) / SU(2)xU(1)**

and

**First F4 describing the Standard Model
has 16 Spinors = 8L (left-handed) + 8R (right-handed)**

For every E8 Gauge Boson there is an E8 Ghost

Steven Weinberg in The Quantum Theory of Fields Vol. II Sec. 15.7 said: "... there is a beautiful geometric interpretation of the ghosts and the BRST symmetry

...

The gauge fields A_a^μ may be written as one-forms $A_a = A_{a\mu} dx_\mu$, where dx_μ are a set of anticommuting c-numbers. ...

This can be combined with the ghost

to compose a one-form $A_a = A_a + w_a$ in an extended space.

Also,

the ordinary exterior derivative $d = dx^\mu d/dx^\mu$ may be combined with the BRST operator s to form an exterior derivative $D = d + s$ in this space, which is nilpotent because $s^2 = d^2 = sd + ds = 0$...".

**The 28-12 = 16 Ghosts in the First D4
correspond to the 16 generators
of the Gravity+Dark Energy and Propagator Phase Gauge Bosons
which Gauge Bosons live in the Second D4**

These 1 + 3 + 8 = 12 grade-2 Cellular Automata correspond to U(1) , SU(2) , SU(3) Gauge Bosons of the Standard Model

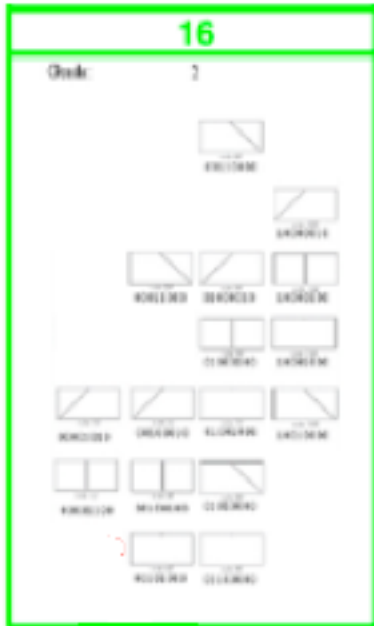

16 Ghosts in First D4 F4 correspond to 16 Gravity+Dark Energy plus Propagator Phase Gauge Bosons that live in Second D4 F4

2 -

Second D4 has 16-dim U(2,2) subgroup

U(2,2) = U(1) x SU(2,2)

U(1) represents Propagator Phase

SU(2,2) = Spin(2,4) = Conformal Group which by MacDowell-Mansouri gives Gauge Bosons for Gravity and Dark Energy

For every E8 Gauge Boson there is an E8 Ghost

Jean Thierry-Mieg in J. Math. Phys. 21 (1980) 2834-2838 said:

“... The ghost and the gauge field:

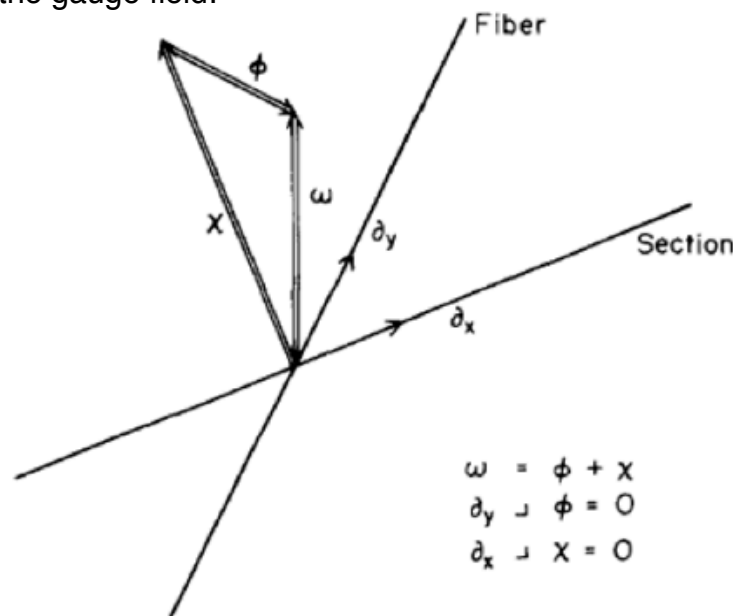

The single lines represent a local coordinate system of a principal fiber bundle of base space-time. The double lines are 1 forms. The connection of the principle bundle ω is assumed to be vertical. Its contravariant components ϕ and χ are recognized, respectively, as the Yang-Mills gauge field and the Faddeev-Popov ghost form ...”.

The 28-16 = 12 Ghosts in the Second D4 correspond to the 12 generators of the Standard Model Gauge Bosons which Gauge Bosons live in the First D4

These 1 + 12 + 3 = 16 grade-2 Cellular Automata correspond to propagator phase, Conformal Lie Algebra Root Vectors, and Conformal Lie Algebra Cartan Subalgebra



**The Conformal Group Spin(2,4) = SU(2,2) gives Gravity+Dark Energy by the MacDowell-Mansouri mechanism.
 U(2,2) = U(1) x SU(2,2) also contains the U(1) propagator phase**

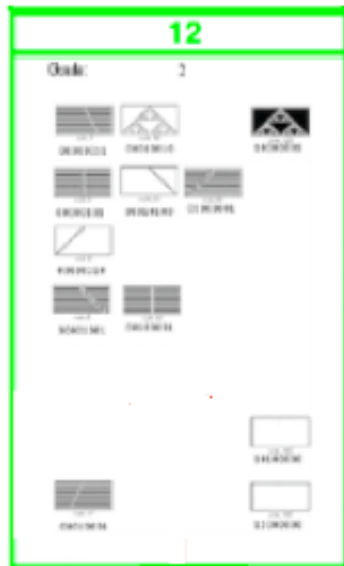

12 Ghosts in Second D4 F4 correspond to 12 Standard Model U(1) SU(2) SU(3) Gauge Bosons that live in First D4 F4

56 Cl(8) TriVectors correspond to Fr3(O) of 26D World-Line=String Theory

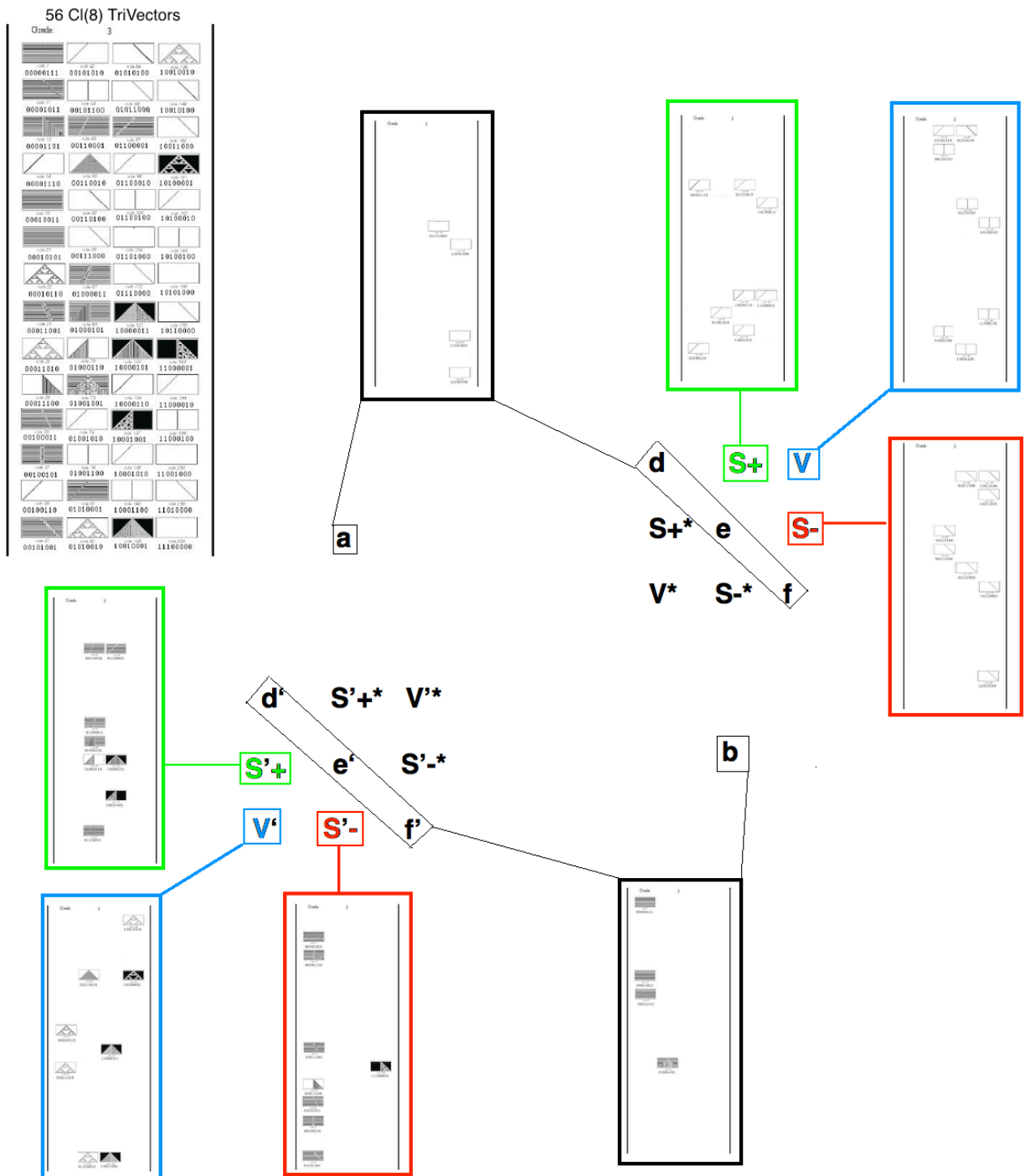

Due to 8-Periodicity of Real Clifford Algebras
 tensor product $Cl(8) \times Cl(8) = Cl(16)$

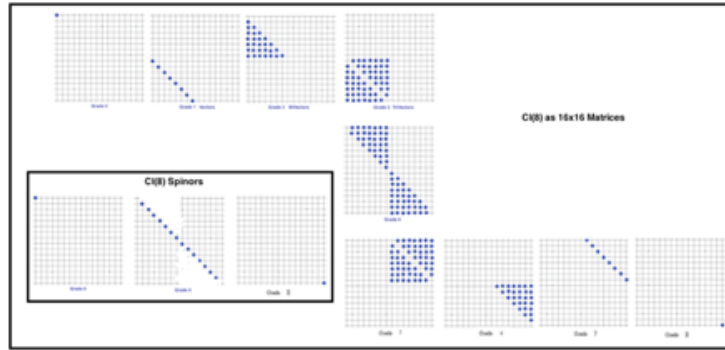

CI(8) as 16x16 Real Matrices
x
CI(8) as 16x16 Real Matrices

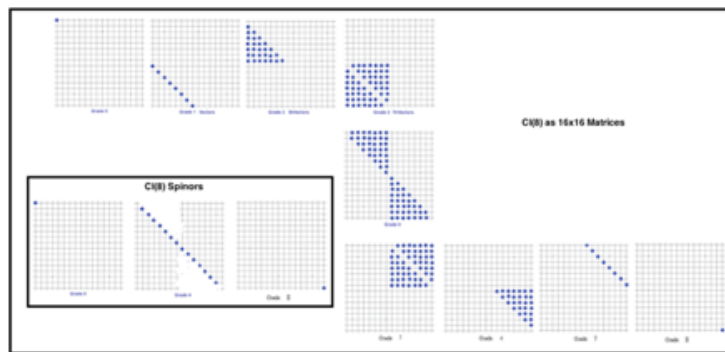

=

CI(16) 256x256 Matrix Representation

CI(16) Vectors
BiVectors TriVectors

