

The physical nature of the basic concepts of physics

7. Extent, Velocity and Length Contraction ⁽ⁱ⁾

Guido F. Nelissen

guido.nelissen@gmail.com

Abstract

Physics today has an ambiguous attitude towards ‘velocity’: on the one hand it considers it a “relative” characteristic of which the numerical value depends on any fortuitously chosen reference frame. But on the other hand that same physics tells us that velocity has an absolute upper limit, which is the speed of light. This duality is caused by the fact that the Lorentz transformations accomplish a purely mathematical bridging between a relative velocity at low speeds and an absolute velocity at the speed of light, which causes a length contraction and a time dilation. But it is not clear whether these are observational or real physical phenomena, which has led to a number of contradictions, such as the “twin paradox”.

According to the present Standard Model, the Universe must have started with massless particles that moved at the speed of light and then something happened in a way that some particles acquired mass, which is in the present physics explained as a kind of ‘drag’ that is exerted by the Higgs field on certain particles. In this paper the author demonstrates that this massless origin of matter, strongly indicates that elementary mass particles (such as e.g. electrons and quarks) are in fact multi-particle systems that consist of entangled photons. This allows him to establish a general speed equation, that expresses the variable speed of a mass particle in function of the degree of congruence of the repetitive motions of its massless components. This means that variable velocity is a thermodynamic state of a particle system, in the same way as its pressure, its temperature or its entropy.

In that way, the obvious fact that the ‘size’ of a dynamic particle system is the area that is covered by the repetitive motions of its components, automatically leads to the Lorentz contraction of a moving mass particle in its direction of motion, which is demonstrated to be a real physical distortion.

This means that the Special Theory of Relativity is above all an observational theory, but that its so-called ‘relativistic’ equations, like e.g. the length contraction, the time dilation and the mass-energy equation and their applications e.g. in Quantum Field Theory, describe real physical phenomena, because they are expressed in function of the absolute speed of light. This reveals the physical nature of mass particles as 3-dimensional particle-wave systems that can vary their speed in 3 directions and the physical nature of photons as 2-dimensional particle-wave systems that proceed at an invariable speed and that have mass characteristics (such as linear momentum) in directions perpendicular to their invariable speed.

(i) Updated edition of the paper “Velocity, mass and time” May 1991 by the same author.

1. The present concept of velocity

Physics always had an ambiguous attitude towards ‘velocity’.

- In 1687, Newton published his “Mathematical Principles of Natural Philosophy” in which all physical manifestations result from mechanical interactions between ‘particles’ and in which length and time are defined in an absolute way, so that velocity was intrinsically considered an absolute physical characteristic. In a general way, Newtonian physics defines velocity as the change of distance per unit time. According to the International Systems of Units (SI):

- The unit of ‘length’ or ‘distance’ is the meter (m), which was first defined as the distance between two scratches on a calibrated bar made of platinum-iridium. Since 1983, the meter is defined as the distance traveled by a light wave of a given laser in vacuum space, in a time interval of $1/299792458^{\text{th}}$ of a second.
- The unit of ‘time’ is the second (s), which was first defined as a $1/24 \times 60 \times 60^{\text{th}}$ of a mean solar day. It is now replaced by the atomic standard of time, which corresponds to 9192631770 vibrations of a cesium-133 atom.

- Besides Newton’s ‘mechanical world view’, the leading theory for light became however the wave theory, developed by Christian Huygens in 1669 in his “Oeuvres Complètes”. Huygens considered light as a wave that was propagating through the ether in a manner analogous to the propagation of sound through the air. Since that propagation is affected by the speed of the air, it was thought that the motion of the earth through the ether would affect the speed of light (the ether drag).

- James Clerk Maxwell first attempted to explain the behavior of electric and magnetic fields in terms of a mechanical world view according to which space was filled with a physical ether, consisting of small rotating ‘vortices’ ⁽ⁱⁱ⁾. Later on he abandoned this mechanical model and in 1873 he published his electromagnetic theory, in which ‘charge’ instead of ‘mass’ was the fundamental entity of matter and in which light was a form of electromagnetic radiation between charged particles. In that way Maxwell replaced the concept of the ‘ether’ by the concept of the electromagnetic ‘field’ that transmitted electromagnetic radiation and that was supposed to exist in its own right, without the need for an underlying ether ^[1].

- In 1881 the ‘Michelson-Morley experiment’ definitely proved that the speed of light was not affected by the motion of Earth through space, which was the end of the theory of the ether drag. In that way Maxwell’s electro-magnetic field theory became the leading theory of light. But it also meant that the speed of light was not consistent with the Galilean velocity addition law.

- In 1892, on the basis of the Michelson-Morley experiment, Hendrik A. Lorentz, who was one of the leading adherents of Maxwell’s electromagnetic theory, published a modification of the Galilean transformation in which, in addition to the transformation equation for the space coordinate ($x' = x - v_0t$), he added a similar transformation equation for the time coordinate ($t' = t - v_0x/c^2$). In that equation he introduced the constant ‘c’, which represents the invariable speed of light in empty space. His equation takes account of the ratio of the speed of the reference frame to the speed of light (v_0/c) and of the time required for the light

(ii) The concept of vacuum space consisting of rotating vortices was first suggested by René Descartes in his “Principles of Philosophy” (1644) and reappears in the present loop quantum gravity in which vacuum space consists of ‘spin’ networks.

to travel from the origin of the reference frame to the body (x/c).

In his dynamical theory, Lorentz explained that the electromagnetic interactions with the field through which they move, modifies the internal structure of the fundamental units of matter (in his electromagnetic theory: electrons) “squeezing them in their direction of motion, so that their form changes from spheres to ellipsoids, with the minor axis in the direction of motion and causing the length of the objects to change” ^[2]. This would mean that in the Michelson-Morley experiment, the arm of the interferometer in the direction of motion would have shrunk just enough to compensate for the expected time difference! Lorentz then calculated that this meant that all physical objects had to be contracted in their direction of motion by a factor related to the square of the ratio of the speed of the object to the speed of

light, which is known as the “Lorentz contraction”: $L_v = L_o \sqrt{1 - v^2/c^2}$

which can be expressed in function of the “Lorentz factor” $\gamma = 1/\sqrt{1 - v^2/c^2}$

So that: $L_v = L_o/\gamma$

It is thereby important to stress the fact that Lorentz was strongly convinced that this “length contraction” is a real physical compression of the moving body in its direction of motion.

In the same year, completely independently from Lorentz, George Fitzgerald came to exactly that same conclusion and therefore Lorentz’ equation is also known as the ‘Lorentz-Fitzgerald contraction’.

In 1904, Lorentz published a new version of his theory which dealt with measurements in different inertial reference frames and in which he introduced his so-called ‘Lorentz transformations’. These transformation equations led him to conclude that not only the length of moving electrons diminishes with increasing speed, but that also a unit time interval between two consecutive ticks dilates with increasing speed (the ‘Lorentz time dilation’):

$$T_v = \frac{T_0}{\sqrt{1 - v^2/c^2}} = \gamma T_0$$

From his assumption of a deformable electron and his transformation equations, Lorentz then derived the expression for the ‘mass increase’ of moving electrons in their direction of motion:

$$m_v = \frac{m_0}{\sqrt{1 - v^2/c^2}} = \gamma m_0$$

Finally his transformations led to his ‘velocity addition law’ for two bodies moving at high speeds u and v : $W = (u + v)/(1 + uv/c^2)$.

This equation corresponds to the ‘Galilean addition law’ for low speeds, and it leads to the invariance of the speed of light if one of the speeds is equal to ‘ c ’.

- In 1905 Albert Einstein published his paper “On the Electrodynamics of Moving Bodies” which later became known as the “Special Theory of Relativity”. Einstein based his whole theory on his two fundamental postulates ^[3] ^[4]:

1. **The relativity postulate:** The laws of physics are the same in all inertial reference frames. This means that all inertial reference frames are equivalent and that it is not possible to find one preferential inertial reference frame as being at absolute rest, so

that only the relative velocity between objects can be measured and is physically meaningful.

2. **The speed of light postulate:** The speed of light in vacuum space is equal to the value ‘c’ independent of the motion of the source of light or of the observer.

On the basis of these two simple postulates, Albert Einstein came directly to a set of transformation equations, that were identical to those elaborated by Lorentz, from which he was able to derive the equations for “time dilation” and “length contraction”.

According to Stanley Goldberg ^[5] “*For Einstein, mass had no such cosmic significance. After all, it was clear to him that he had produced a theory of measurement, not a theory of matter*”. So Einstein replaced Lorentz’ mass increase equation of the mass increase by his own relativistic equation of the energy increase, of moving bodies:

$$E = \frac{mc^2}{\sqrt{1 - v^2/c^2}} = \gamma mc^2$$

Which for $v = 0$ leads to Einstein’s famous mass-energy equation of the so-called “rest” mass of a mass particle: $E = mc^2$.

In his special theory of relativity, Einstein however demonstrated that motion (and therefore velocity) is a relative characteristic of which the numerical value is determined by the (arbitrarily) chosen reference frame (which is consequently also the case for its derived characteristics, such as ‘linear momentum’ and ‘kinetic energy’). It was thereby considered a reassuring factor, that despite the fact that observers in different inertial reference frames would disagree about the values of these fundamental characteristics, they all would agree that their numerical values are conserved in physical interactions, so that the conservation laws would remain valid in all reference frames.

In his book “*Über die spezielle und die allgemeine Relativitätstheorie*” ^[6] Einstein writes that he extracted the special theory of relativity from the Maxwell-Lorentz theory on electromagnetic phenomena. He thereby explains that Lorentz’ theory is based on the hypothesis that electrons undergo a physical contraction in their direction of motion, but that there is no proof for that hypothesis. He also underlines the fact that his ‘Special Theory of Relativity’ comes to exactly the same equations as Lorentz, without the need for any hypothesis about the composition of matter (electrons or other) or the existence of an ‘ether’, because in his theory, the contraction of moving bodies follows directly from his basic postulates in which there is no preferential reference system and consequently no ether drift. Einstein thereby stresses his view, that crucial for his relativistic theory, is not the motion of the body itself, but the motion with respect to a chosen reference frame!

2. The physical ambiguity of the relativistic velocity concept

2.1 The fundamental difference between Lorentz’ and Einstein’s view

In his book “Understanding Relativity” Stanley Goldberg underlines the deep, fundamental difference between the Einstein and the Lorentz-Fitzgerald views about the length contraction ^[7]: “*Whereas Lorentz considered the length contraction as a real physical phenomenon and tried to understand it in physical terms, the question of the reality of the contraction did not arise in Einstein’s analysis*”. “*In Einstein’s view the discrepancies are not a result of squeezing of rods; rather, a result of the way we measure.*”

According to Stanley Goldberg this complete difference of opinion between Lorentz and Einstein’s view on the length contraction didn’t much trouble the physicists of that time ^[8]:

“In the minds of many, since the predictions of Einstein and Lorentz were the same, they were seen as aspects of the same theory. Even supporters of Einstein shared this confusion: for example, Max Planck referred to the Lorentz-Einstein theory and Hermann Minkowski, the man who is credited with generalizing Einstein’s theory to four dimensions, remarked that Einstein’s work was a generalization of Lorentz’s”.

Lorentz however never changed his mind about the physical nature of the length contraction. Shortly before his death he wrote ^[9]: *“I should like to emphasize the fact that the variations of length caused by a translation, are real phenomena, no less than for instance, the variations that are produced by changes of temperature”.*

This complete disagreement between Lorentz's absolute and Einstein's relative viewpoints in regard of the real nature of velocity and the associated length contraction, has however never been properly cleared out. According to Max Planck *“New ideas do not gain favor by changing the minds of established individuals in the field. Rather, as the older members of a profession die, they are replaced by younger men who become familiar with the newer idea's, and eventually recognize the advantages of replacing the old with the new”* and concludes that *“Individuals, Planck included, elaborated on the consequences of the theory. It was that elaboration that more and more revealed the heuristic power of Einstein’s formulation and the lack of it in the Lorentz formulation, that led to the gradual appearance of the Einstein theory in textbook formulations”.*

It is in that way that over the years, Einstein’s Special Theory of Relativity has become the cornerstone of the present theory of motion and Lorentz’ contribution is restricted to the mathematical equations that fit in with Einstein’s theory, such as e.g. “the Lorentz transformations”, the “Lorentz(-Fitzgerald) contraction” and “the “time-dilation (but not the “mass increase”, which is replaced by Einstein’s relativistic energy equation)”.

2.2 The ambiguity of the present Physics textbooks

So the problem of the nature of velocity seems to be solved. But is this really the case?

The Lorentz transformations, on which Einstein’s Special theory of Relativity is based, make a purely mathematical overlap between relative velocities at low speeds and an absolute velocity at the speed of light. But it is not at all clear whether these equations describe observational or real physical phenomena. Lorentz’ dynamic theory tried to explain the distortion of matter in relation to an increasing velocity, whereas Einstein’s kinematic theory describes the relation between observations of different events in reference frames that have increasing speeds relative to each other.

This ambiguity between both points of view has never really been cleared out and still blurs modern textbooks, as is demonstrated by the following examples.

1. The textbook “Physics – Second Edition, Expanded” ^[10].
 - **Time-dilation:** *“As measured by the clocks on the Earth, the clock on the spaceship runs slow. **The time-dilation effect is symmetric:** as measured by the clocks on the spaceship, a clock on the Earth runs slow by the same factor. The slowing down of the rate of lapse of time applies to all physical processes. In accurate experiments performed at CERN, muons with a speed of 0,999c were found to have an average lifetime 29 times as large as that of muons at rest.”*
 - **Length contraction:** *“Suppose that a rigid body is at rest in a spaceship moving relative to the Earth. The length of the body measured in the reference frame of the Earth is shorter than the length measured in the reference frame of the spaceship. **This effect is symmetric:** a body at rest on the Earth will suffer from*

contraction when measured by instruments on board of the spaceship. The length contraction has not been tested directly by experiment.”

2. The textbook “Physics for Scientists and Engineers with Modern Physics – Third Edition” [11]:
 - **Time-dilation:** *“Moving clocks are observed to run more slowly than clocks at rest do. It is not that the clocks are physically altered, rather time intervals that are observed in different inertial frames differ.” “The time dilation is a symmetric effect. The time-dilation effect is real: We can produce experimental evidence with measurements of the half-lives of radioactive nuclei or unstable particles in motion.”*
 - **Length contraction:** *“The slowing down of moving clocks is accompanied by the contraction of the length of moving objects along their direction of motion.” “To the moving observer, the atmospheric height, or any length in the direction of his motion, has undergone a length contraction.”*

3. The textbook “Modern Physics” [12]:
 - **Time-dilation, or time stretching:** *“Observers in S conclude that the clock in S’ runs slow since that clock measures a smaller time interval between the two events.” “In 2010 J. C.-W. Chou at NIST used precision optical clocks to detect the minuscule time dilation at a speed of only 10 m/s. These experimental result leave little basis for further debate as to whether **traveling clocks lose time**. They do.”*
 - **Length contraction:** *“The length of an object measured in the reference frame in which the object is at rest, is called its proper length. In a reference frame in which the object is moving, **the measured length parallel to the direction of motion is shorter** than its proper length.”*

4. The book “Relativity, Gravitation and Cosmology” [13]:
 - **Time-dilation:** *“Any inertial observer will find that time passes more slowly for any other inertial observer who is in relative motion. **Both will be right because time is a relative quantity, not an absolute one.**”*
 - **Length contraction:** *“The rod is observed to be shorter in the laboratory frame than in its own rest frame. In short moving rods contract. **Any moving rod will be observed to contract in its direction of motion.**” And further: “Length contraction is called Lorentz-Fitzgerald contraction, though their interpretation was rather different from that of Einstein”.*

All these descriptions are in some way ambiguous, not only because they contradict each other in subtle ways, but especially because they contradict themselves by underlining that these effects are relative and therefore fully symmetric and suggest at the same time that they are real!

It is indeed a paradox that a relative speed, that completely depends on an arbitrarily chosen reference frame, can have physical consequences, such as e.g. the time-dilation of the muon decay! Even Einstein himself sustained this ambiguity, because in his theory he considers time dilation a genuine phenomenon [14].

It is this intrinsic ambiguity that has led to the well-known contradictions, such as e.g. the “twin paradox” and the “pole and barn paradox.”

2.3 The ambiguity of the time dilation

When we leaf through the present textbooks of physics, all these considerations oblige us to conclude that roughly a hundred years later, the differences in opinion between Lorentz and Einstein about the real nature of the length contraction and the time-dilation have never been properly cleared out and therefore the question remains whether it are genuine physical processes or merely an observation problems?

Because observations are necessarily relative, this means that the Special Theory of Relativity is fundamentally an observational theory. But observations are fundamentally symmetric and cannot change the observed (macroscopic) bodies: if I see you moving at $0,1c$ in a given direction, then you see me moving at $0,1c$ in the opposite direction and if I see you becoming shorter when you move, then you see me becoming shorter in the same proportion. This is clearly stated by Kenneth Denbigh^[15]: “*observers at places such as P will regard the clock P_0 as running slow relative to their own clocks. **But of course this is a symmetrical effect**, for the observer at P_0 will regard the clock at P, which is in relative motion, as running slow*”. This means that Einstein’s relativistic theory is above all an observational theory, and from 1905 till 1936 this was evidently so.

But in 1936 Seth Neddermeyer observed muons at sea level! These muons, that have a life time of $2\mu s$, arise more than 7000 meter above sea level and move at a velocity of $0,999c$, which means that they can only move over a distance of 600 meter. The reason why muons are nevertheless observed 7000 meter below is that, because of their high speed, their lifetime has physically increased from $2\mu s$ to $30\mu s$, so that they can now travel over 9000 meter and be observed at sea level. It is as a result of this asymmetric, unilateral increased lifetime of the high speed muons, which is completely opposite to the symmetric relativistic view, that in 1957 C. G. Darwin published his paper in Nature on the “Twin Paradox”.

It is thereby important to realize that the paradox is not the (eventual) reunion of the twins, but the fact that a so-called ‘relative’ speed can have a unilateral, hard physical consequence, such as the increase of the lifetime of a high speed object.

To solve these ambiguities once and for all, we have to unveil the real, physical nature of velocity and speed in a clear, unambiguous way.

3. The physical nature of the ‘size’ or ‘extent’ of a particle system

In Einstein’s Special Theory of Relativity, that was developed at the beginning of the twentieth century, a ‘body’ is considered as a monolithic object without internal structure, and its speed is considered in relation to any imaginable “frame of reference”.

But in nature, all material objects are in fact composite, multi-particle systems, composed of molecules, that are composed of atoms, that are further composed of a nucleus surrounded by electrons. This nucleus is on its turn composed of protons and neutrons, which are on their turn composed of quarks, ...

This means that all material objects are in reality multi-level “particle-systems” that consist of some very small ‘basic’ constituents that are rapidly moving about each other. In that way the ‘shape’, ‘size’ or ‘extent’ of an observable (macroscopic) ‘particle’ is nothing else than the area that is repetitively covered by the motions of its ‘pointlike’ constituents. (This phenomenon is comparable to the glowing ‘donut’ that is perceived when one rapidly sweeps the glowing point at the end of a wooden stick around in the dark.)

This means that a particle system, consisting of rapidly moving, undetectably small

components that repeatedly cover a three dimensional area with a radius ‘R’, will be perceived as a solid ‘particle’ with a diameter ‘2R’ and some sort of internal rotational - vibrational motion.

These dynamic, multi-level particles systems, that are built up from undetectably small basic unit particles and that are subjectively perceived as massif ‘particles’, corresponds quite well to the historical development of our view on the structure of matter: from Rutherford’s massif proton nucleus, that later appeared to consist of vibrating protons and neutrons, which later appeared to consist of quarks, ..).

This leads us to a dynamical ‘particle’ model in which all observable ‘particles’ are in reality dynamic wavelike particle clouds of the underlying basic particles.

- Such a dynamic, multilevel translational/rotational/vibrational particle system will have more chance to be perceived as a massif ‘particle’, when the distribution of its components is denser and/or their angular velocity is greater. So the reason why protons are not designated as ‘quark clouds’, is that the existence of protons has been assumed in 1886, some 80 years before the discovery of quarks in 1968 ^[16].
- It will, on the contrary have more chance to be perceived as a ‘particle cloud’, when the distribution of its components is less dense and their angular velocity is lower. A typical example of this is the so-called “angular probability density of electron clouds”. The reason why an electron cloud is not seen as a “particle” is that the existence of electrons was assumed in 1895 by Joseph Thomson, approximately 30 years before the establishment of electron clouds on the basis of Schrödinger’s equation in 1926 (Fig 7.1)

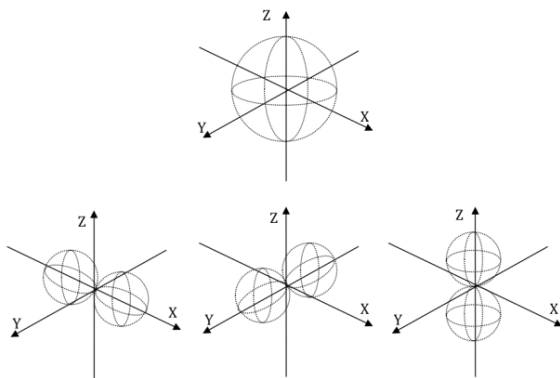

Fig. 7.1

Since these so-called particle clouds represent the repetitive motions of the considered particles. The places where it passes more frequently are as a matter of fact the places where the probability to find it is higher. In that way, the strange sounding probabilistic principles of quantum mechanics, e.g. that the intensity of a wave at some point is proportional to the probability of finding the particle there, become self-evident!

For smaller components with much higher velocities, the repetitive trajectories will have a greater chance to be perceived as a single ‘particle’ or ‘wave-packet’ (Fig 7.2).

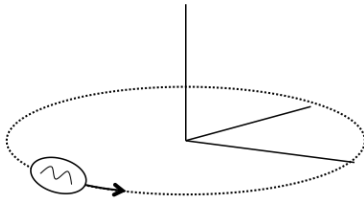

Fig. 7.2

From this perspective, all detectable ‘particles’ (and even space itself) can be seen as dynamic vibrating/rotating structures of basic, undetectable elements . When these dynamic structures become stable, they obtain new, emerging macroscopic properties, in the same way that a ‘swarm’ of bees, a ‘colony’ of ants, or a ‘flock’ of birds can be seen as new entities with their own specific (group) characteristics. This view corresponds quit well to the view of Don Lincoln ^[17] who demonstrates that, although the present Standard Model treats the basic particles (quarks, leptons and bosons) as pointlike, zero size particles without internal structure, the patterns within the Standard Model raise the possibility that the differences of their characteristics (mass, charge, spin, ..) are caused by the nature of smaller underlying particles (Which Don Lincoln calls ‘preons’.

4. The physical nature of the ‘velocity’ of multi-particle systems

4.1 The variable speed of multi-particle systems

In my paper Part 6 “The physical nature of entropy” section 2.3.1 “The degree of coherence of a particle system”, I have demonstrated that an adiabatic expansion in the x-direction causes a partial rectification/rotation, of the isotropic thermal velocities of the particles into that direction and produces in that way an increase of the congruent translational motion in the x-direction, at the expense of its isotropic thermal motion ⁽ⁱⁱⁱ⁾.

In that way the degree of ‘rectification’ can be represented by the sinus of the angular rectification ‘ α ’, so that: $v = q_h \sin\alpha$ and $q_c = q_h \cos\alpha$

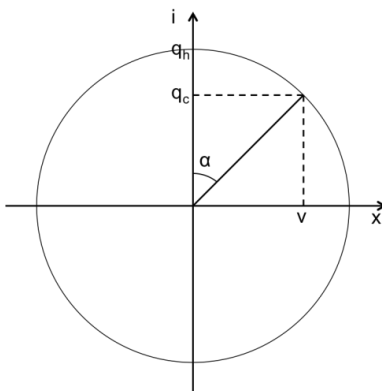

FIG 7.3

(iii) For the classic Earth bound applications, where one disposes of a fixed, immovable point. In the case where there is no stationary point (e.g. in space) the adiabatic expansion will cause a symmetrical rectification in both opposite directions of the x-axis, but the principle of the rectification of thermal motion remains the same.

In this representation of the velocities of a particle system, the angle of ‘coherence’, ‘congruence’ or ‘rectification’ (α), is the angle between the isotropic velocity axis ‘i’ and the total speed ‘z’.

From this we can define the degree of ‘coherence’, ‘congruence or ‘rectification’ of the velocities of the particles, as the sine of the rectification angle ‘ α ’:

$$\sin\alpha = v/q_h \text{ or } v = q_h \sin\alpha$$

- If α is 0° , $\sin\alpha = 0$ There is only isotropic motion
- If α is 90° , $\sin\alpha = 1$ All motion is rectified into congruent motion.

In that way the congruent (RMS) speed of a particle system as a whole varies in function of the degree of congruency of the velocities of the individual particles.

- When the velocities of the basic elements of a such a composite particle system are completely isotropic, they will not produce a resultant velocity ($v = 0$) so that the total amount of motion will be present in the particle system under the form of internal, isotropic, thermal velocity, with an RMS-speed ‘ q_h ’. The velocity distribution of the basic particles can in that case be represented in 3 dimensions as a sphere with a radius ‘ q_h ’.
- When all the basic elements move in a congruent way, that is at the same time with the same speed ‘ v ’ in the same direction, the particle system as a whole will move in this direction with a congruent velocity ‘ v ’. In that case the velocity distribution of the basic elements can be represented by a single vector in the x-direction with a length ‘ $v = q_h$ ’.
- In the intermediate cases, the velocities of the basic particles will produce a resultant or congruent velocity ‘ v ’ ($0 < v < q_h$) with which the particle system will move as a whole.

4.2. The upper speed limit of multi-particle systems

In section 3, I have demonstrated that ‘particles’ that we are able to detect, are in fact ‘multi-particle systems’ that consist of undetectably small ‘unit’ particles that are moving at high speeds about each other.

According to Wikipedia ^[18] “*The speed of light is a physical constant that expresses the absolute, invariable speed at which massless particles and electromagnetic waves travel in vacuum space and which constitutes the maximum speed at which matter can travel.*”

This definition of the speed of light, as the maximum speed at which mass particles can travel, strongly suggests that the elementary mass particles (such as electrons, quarks and the weak gauge bosons) are in fact multi-particle systems, that consist of entangled photons.

This seems a bold hypothesis, but it fully complies with:

- the process of ‘gamma decay’, whereby high energy photons are emitted from the mass particles of the nucleus,
- with the electron-positron annihilation and creation, whereby an electron-positron pair is transformed into photons and vice-versa, and
- with the fact that electrons interact by exchanging photons between which each other.

The built up of mass ‘particles’ from massless particles, completely matches the requirement of the Standard Model, that the Universe has started with massless particles, because if

particles had mass from the beginning, that would spoil gauge symmetry and the Standard Model would have led to nonsensical predictions.

- According to Brian Cox and Jeff Forshaw ^[19]: “*Abandoning gauge symmetry is not an option, because then the theory falls apart and stops making sense*”. “*This apparent impasse was solved by the Higgs mechanism, in which we started with a universe in which mass didn’t exist and everything moved around at the speed of light*” ^(iv). Then ‘something’ happened such that some ‘particles’ started to move with different lower speeds.”

That ‘something’ is the Higgs mechanism, in which the different masses are generated as a result of different interactions with the background Higgs field. Just like the electromagnetic field is associated with a particle (the electron), the Higgs field is associated with the Higgs particle. This means that in the Higgs mechanism “mass” is considered as a kind of ‘drag’ (like for fast cars and airplanes moving through the air) that is exerted on some massless particles.

- Lisa Randall is more skeptical about the Higgs mechanism when she writes that ^[20]: “*The Higgs boson is part of a very particular implementation, which only further data will definitely confirm or rule out*”. “*Such an elementary particle mass (such as the electron) relies on the existence of what particle physicists call a field - a quantity that exists throughout space, but that doesn’t necessarily involve any actual particles. Admittedly, the concept of a field is a bit esoteric and confusing, especially as the word field outside of physics conjures images of cows grazing*” ^(v).

All three physicists admit that the advantage of the Higgs field is that it gives masses to the initially massless particles of the Standard Model, without paying the price of losing gauge symmetry ^(vi).

Although the actual processes at the first moments of the Big Bang are not exactly known, this view of the Standard Model on the massless beginning of the universe, fully complies with the descriptions of the first moments after the Big Bang ^[21]: “*In the beginning the universe was dominated by **energy** at negative pressure, which led to an early exponentially accelerated expansion, referred to as inflation. ... Following that brief but extremely rapid inflation, the universe was first dominated by **radiation** and then subsequently by matter*” and ^[22] “*The original universe was a very small roll pure concentrated **energy***”.

And yet another element in favor of the massless built up of mass particles, is given by the escape velocity of black holes (which approach the extreme conditions of the big bang). The escape velocity of a celestial body (with radius R and mass M) is equal to the impact velocity of any object that is initially at rest ($v_i = 0$) and that falls from a very large distance ($r = \infty$) to that celestial body. In classic physics, the initial total energy of such an object, which is the sum of its kinetic and its potential energy, is zero:

$$mv^2/2 - GMm/r = 0$$

When that falling object reaches the surface of the celestial body ($r = R$), its impact velocity, which is equal to the escape velocity, is: then $v_{\text{esc}} = \sqrt{2GM/R}$

For a black hole, the escape velocity is equal to the speed of light ($v_{\text{esc}} = c$), which means that the radius (R) of the black hole must at least be equal to: $R \leq 2GM/c^2$.

It follows from this that the impact velocity of a black hole is also equal to the speed of light. Since only massless particles can travel at the speed of light, this necessarily means that the falling object must necessarily have disintegrated into photons.

(iv) Which means that everything was ‘light’.

(v) The physical nature of ‘fields’ will be analyzed in my paper on “Potential Energy”.

(vi) The Higgs mechanism doesn’t however explain the gravitational attraction of the acquired masses, which I

4.3. Mass particles as bound states of photons

The former examples of the permanent interchange between mass particles and photons as well as the invariable upper limit, strongly indicates that elementary mass particles consist of entangled photons (given the de Broglie wave characteristic of photons and of mass particles, this is probably materialized under the form of some kind of circular standing waves).

The problem is however that photons are Bosons that are not known to easily interact with one another!

In 1991, Allan Snyder^[23] then head of the Optical Science Centre at the Australian National University, has demonstrated that if two intense light beams are brought close enough together, they may attract or repel each other, depending on whether they are in or out of phase with each other.

This is recently confirmed by publication of the paper^[24] “*Observation of three-photon bound states in a quantum nonlinear medium*” in Science of February 16, 2018 which confirms this interacting property of photons. A team of scientists of Massachusetts Institute of Technology, Harvard University, University of Maryland, Princeton University and University of Chicago have experimentally demonstrated that, under extreme circumstances, pairs and even triplets of photons can effectively interact with each other and form pairs and triplets of entangled photons. Their phase was shifted compared to that of free photons, which means that they were strongly entangled. These “atoms of light”, as they are called, were not travelling at the speed of light, but had moderate velocities of $0,0001c$ (30km/s) to $0,00001c$ (3km/s), and a fraction of the electron’s mass!

In 2013 the team already had made pairs of bound photons in that way, but this was the first time they made triplets of bound photons.

These result meets the condition of the Standard Model, that shortly after the Big Bang, ‘something’ happened and we now know that this ‘something’ is the entanglement of the initial photons into mass particles (like e.g. neutrino’s, etc.) which allowed them to form composite particle systems with variable velocity from 0 to the speed of light^(vii).

4.4. A new physical speed equation for mass particles

From the former sections we can conclude that elementary mass particles are not monolithic objects, but that it are in fact 3-dimensional particle systems that consist of massless particles, moving about each other, so that the variable velocity of a mass particle system can be represented as a complex number, in which the real number ‘v’ indicates the congruent velocity of which the particle system moves as a whole in a given direction, and in which the imaginary number ‘q’ indicates the internal RMS-speed ‘q’ in all three directions. This can be represented by a 2-dimensional picture (Fig. 7.4).

(vii) The nature of mass and its applications will be analyzed in my paper on the physical nature of mass.

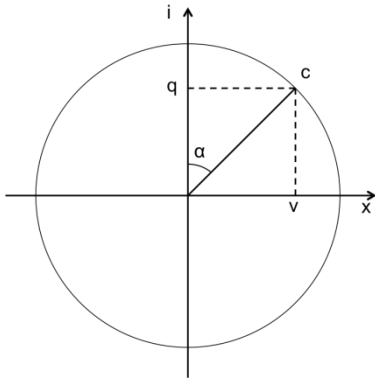

Fig. 7.4

In this way the total velocity of each massless component is equal to the speed of light, so that:

$$v^2 + q^2 = c^2$$

$$\text{or } v^2/c^2 + q^2/c^2 = 1$$

$$\text{and } \sin^2\alpha + \cos^2\alpha = 1$$

In this representation both, the congruent velocity of the particle system ' v/c ' and the internal RMS-speed ' q/c ', are both expressed as a fraction of the speed of light.

In the Lorentz transformations, this absolute representation of the speed of an object as a fraction of the absolute, invariable speed of light, is commonly represented as:

$$\beta = v/c.$$

This representation allows us to define a degree of 'rectification', 'coherence', or 'congruence' of the particles' motion, which is equal to the sinus of the mean angle of rectification ' α ', so that: $\beta = v/c = \sin\alpha$

so that:

$$\gamma = 1/\sqrt{1 - v^2/c^2} = \gamma = 1/\sqrt{1 - \sin^2\alpha} = 1/\sqrt{\cos^2\alpha} = 1/\cos\alpha$$

In that way the speed of a particle system can be expressed as the degree of congruence of the individual particles' motions, as:

$$v = c \cdot \sin\alpha$$

This means that the variable speed of a mass particle system is an absolute physical state of that system, that expresses the degree of rectification or entanglement, of the (invariable) speeds of its massless components.

My conclusion may at first sight look strange, but it is in fact already currently used in physics, when one expresses the variable speed of mass particles as a fraction of the speed of light, such as e.g. muons that move at $\beta = v/c = 0,998$, which means that $\sin\alpha = 0,998$ and that the angle of rectification $\alpha = 86,3757^\circ$.

5. The physical nature of the Lorentz contraction

In section 3, I came to the conclusion that the ‘size’ or ‘extent’ of a ‘particle cloud’ is the area that is repeatedly covered by the repetitive motions of its basic constituents.

In section 4.3 I have demonstrated, that when such a particle cloud is at rest as a whole ($v_c = 0$), the angular distribution of the (invariable) speeds of the elementary particles will be isotropic ($\alpha = 0$), which means that the velocity distribution of the particle cloud will have the form of a sphere with a radius ‘c’, which represents also the area that is covered by the repetitive motions of its basic constituents (Fig. 7.5).

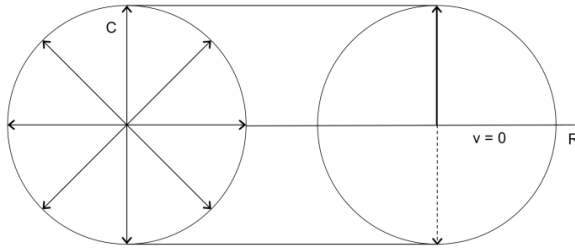

FIG. 7.5

If this particle system moves however as a whole with a velocity ‘ $v = c \cdot \sin \alpha$ ’ in a given direction (e.g. the x-axis), then according to our physical velocity concept, the speed distribution will be rectified by an angle ‘ α ’ in the direction of the congruent velocity.

This rectification results in the fact that in the x-direction, the repetitive internal motions of the basic particles will have diminished at the benefit of their congruent translational motion, while the repetitive internal motion in the plane ‘yz’ perpendicular to this direction has remained unchanged. This means that the particle system has received an anisotropic contraction in the x-direction, while it remains unchanged in the yz-directions and that the originally spherical form of the particle cloud has transformed into an ellipsoid, exactly in the way that described by Lorentz.

Since I have demonstrated that the size and the shape of a composite “particle” is determined by the repetitive internal motion of its basic components (which we represented by their internal repetitive RMS-speed ‘q’) this means that the size of the composite ‘particle’ in the direction of its congruent velocity ‘v’ will be proportional to the value of ‘q’ in that direction (Fig. 7.6).

It follows from this, that the proportion of the size in the direction of motion (l_v) of this ellipsoid to its size at rest (l_0) will be equal to the proportion of the internal speed (q) in its direction of motion to the internal speed at rest (c), so that:

$$l_v/l_0 = 1/\gamma = q/c = \cos \alpha$$

Which can also be written as: $l_v/l_0 = (1 - \sin^2 \alpha)^{1/2}$

Which, since $\sin \alpha = v/c$, gives us the equation of the Lorentz contraction of moving mass particles:

$$l_v/l_0 = (1 - v^2/c^2)^{1/2}$$

This equation of the length contraction expresses the proportion between the size of a moving particle system in its direction of (congruent) motion to its size when at rest.

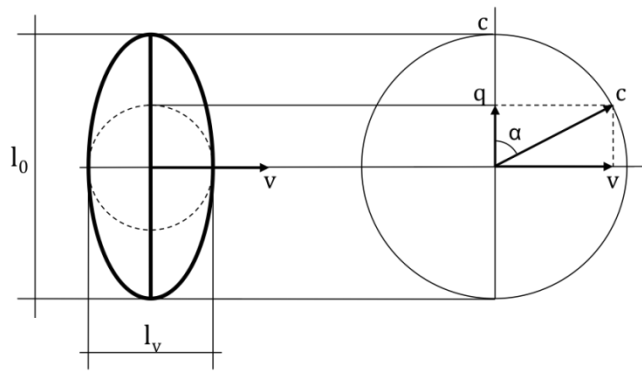

Fig. 7.6

In that way, the velocity is given by the degree of rectification of the motions of the basic massless particles (v/c), which is expressed as the sine of the angle of rectification ' α '. And the length contraction, which is expressed as the cosine of ' α '.

Angle of Rectification	$\sin\alpha$ (v/c)	$\cos\alpha$ (l_v/l_0)
0°	0.000	1.000
1°	0.017	0.999
12°	0.208	0.978
20°	0,342	0,939
25°	0,422	0,906
30°	0.500	0.866
45°	0.707	0.707
60°	0.866	0.500
70°	0,939	0,342
78°	0.978	0.208
90°	1.000	0.000

Since I derived the equation of the length contraction from the calculation of the physical area that is repeatedly covered by the motions of the elementary components, this variation of the size in the direction of motion is not an observation or a measurement problem, but it is, as Lorentz has formulated it (see section 2): *“a real physical distortion, no less than for instance, the variations of length that are produced by thermal expansion”*^(viii).

The physical meaning of the length contraction can be described in yet another way. The size or extend of a particle system is determined by the area that is covered by the repetitive internal isotropic motion of its components. A part of these repetitive internal motions in a given direction is transformed in congruent motion, so that the particle system's 'size' shrinks in that particular direction.

Although the mechanism of this phenomenon lies far deeper, it is, as Lorentz has expressed it: *“of the same nature as the well-known phenomenon of thermal dilation that is perceived when the temperature of material objects is increased”*. In that case, the molecules in solids are held together by inter molecular forces that act like springs and the molecules vibrate about their equilibrium position with an average amplitude that depends on their 'thermal' speed and it is the amplitude of these oscillations that determine the size of these solids.

(viii) The dynamical analysis of the forces and the energy involved in this length contraction will be analyzed in my paper on the physical nature of 'mass'.

This amplitude 'L' can be calculated from the energy conservation in a mass-spring system:

$$mv^2/2 = kL^2/2 \text{ and } L = v\sqrt{m/k}$$

so that the relative displacement of the thermal dilation is proportional to the average thermal speed of the individual particles.

6. The physical nature of photons

In the former section, I came to the conclusion that an accelerating mass particle undergoes a physical compression in its direction of motion, which is mathematically expressed as the proportion of the size of the mass particle in its x-direction of (congruent) motion to its size in the y- and z-direction: $l_v/l_0 = (1-v^2/c^2)^{1/2} = 1/\gamma$

It follows automatically from this equation, that when the speed in the x-direction of a mass particle reaches the speed of light 'c', the repetitive motions and consequently the size 'l_v' of that mass particle in its direction of motion will virtually have become zero. This means that we now have obtained a particle system that proceeds with the invariable speed of light and that has only variable internal translational-vibrational-rotational motion in a plane that stands transversal on the direction of its invariable speed.

This phenomenon is identical to the view elaborated in the present quantum field theory with regard to the increasing speed of spin 1/2 fermions, such as electrons, neutrino's and quarks. The spin angular momentum of quantum particles like electrons, does not change in magnitude, but appears to turn toward the direction of the velocity vector of the particle. In that way, as the velocity of the electron approaches the speed of light, its angular momentum vector (spin) and its velocity vector point in the same direction ^[25]. This means that at the speed of light, mass particles turn into photons ^(ix) of which the spin is always aligned with the velocity vector, either in the direction of its velocity (Fig. 7.7) or in the opposite direction.

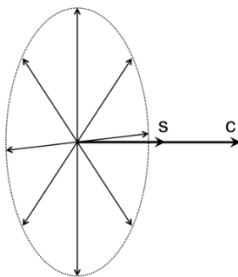

Fig. 7.7

The increasing contraction of an accelerating mass particle in its direction of motion, as represented in my figures 7.6 and Fig. 7.7, is explained in the same way by Jim Baggott in his presentation "The Concept of Mass" on YouTube ^[26]. In that presentation, Jim Baggott considers a steadily increasing mass particle that undergoes a seamless transition, from a spherical particle at standstill, to an ellipsoid at high speed and to a flat circle perpendicular to its speed at the speed of light!

This confirms my conclusion at the end of sections 4.2 and 4.3, that mass particles are built up from massless particles and it demonstrates that whenever mass particles reach the speed

(ix) The concept of photons was introduced by Einstein in his paper on the photoelectric effect, for which he received the Nobel Prize in 1921.

of light, they simply become light!

And that is the real, physical explanation of Einstein's mass-energy equation for the rest mass: $E = m_0c^2$ which is in fact a demonstration that mass particles are built up from entangled photons.

This finally allows us to conclude that mass particles are in fact 3-dimensional multi particle systems that have mass and can vary their speed in all 3 directions and that consist of bound photons that are 2-dimensional particle systems that proceed at the invariable speed of light and that can only vary their speed (and have mass characteristics, such as linear momentum) in the directions that stand perpendicular on their propagation.

This conclusion corresponds quit well with the present concept of weak force symmetry breaking, in which ^[27]:

- massive weak gauge bosons that have mass and travel at less than the speed of light, have 3 polarizations and oscillate in all three directions,
- massless gauge bosons that travel at the speed of light, have only 2 polarizations that oscillate in the directions that stand perpendicular on their direction of motion. The third polarization, which is called the longitudinal polarization because it oscillates along the direction of motion, doesn't exist in the case of massless particles such as photons.

In that way, the apparent 'mystery', namely that the speed of a light beam that is sent from a light emitting source that moves with any given speed, cannot be affected by the motion of the source and cannot affect the motion of the receiver, becomes self-evident and it also explains the so-called curved trajectory of light rays passing near the sun, by means of the transverse mass characteristics of photons ^(x).

7. The headlight effect

In order to give a physical interpretation of my velocity equation, I want to focus the attention on the "headlight effect" ^[28], which demonstrates that, although the speed of light is independent of the motion of the light source, this is not true for the direction of the emitted light.

A light source in S' that is at rest, emits light uniformly in all directions, which can be represented e.g. by a sphere with radius 'c'. When that source S' moves with a velocity β ($= v/c = \sin\alpha$) to the reference system S , of the observer, a ray of light that is emitted by S' at an angle θ' with respect to the direction of its motion, will appear concentrated in an angle θ in the forward direction for the observer, according to the relativistic equation:

$$\cos\theta = (\cos\theta' + \beta)/(1 + \beta\cos\theta')$$

For the rays emitted between $\theta' = \pm \pi/2$: $\cos\theta' = 0$

and this equation becomes: $\cos\theta = v/c$

so that: $v = c.\cos\theta$

This means that, for a speed of e.g. $v/c = 0,94$, the angle of dispersion θ (which is the complement of my angle of rectification $\theta = 90^\circ - \alpha$) is equal to: $\theta = 20^\circ$ (or $\alpha = 70^\circ$ - see my table at section 5). This means that the observer in S sees half of the light in his direction concentrated into a forward cone with an angle of 20° , while the remaining 50% of the light emitted by the moving source is distributed throughout the remaining 340° .

(x) The transverse gravitational attraction of photons by means of their transversal mass characteristics, will be analyzed in my papers on the physical nature of 'gravitation'.

The problem with the relativistic interpretation of ‘the headlight effect’ is that it doesn’t explain how it is possible that the speed of the light rays remain invariant while the light source moves with a velocity ‘v’ in a given direction.

- If the velocity of the source would add up to the speed of the light rays, then the rays in the direction of motion of the source would exceed the speed of light, which is excluded.
- If the speed of the light rays would remain constant, they would be deflected into a backward cone instead of a forward cone, which is not at all the case.

So the only way for the light to proceed in a given direction, while keeping the speed of its rays constant, is by rotating/rectifying them in the forward direction. This confirms my view that the experimental fact, that the photons of a moving source appear turned to the forward direction, proves that the rectification in the forward direction is the cause of its speed.

8. Conclusion: The physical nature of variable velocity

In section 4.3 of my paper Part 5 on the physical nature of temperature and thermal energy, I have demonstrated that the thermal motion of a particle system is an absolute physical characteristic which is responsible for extreme physical phenomena, such as the melting and even the evaporation of hard solid rocks.

In section 1.1.2 of my paper Part 6 “The physical nature of entropy”, I have demonstrated that the Carnot process acts as a (partial) rectifier of the isotropic thermal motion of the particles into congruent translational motion.

It follows from both considerations that the congruent translational motion of a particle system is an absolute physical state of that system, that can be expressed as the degree of rectification of the motions of its basic components.

Although this absolute, physical nature of variable velocity is a completely new viewpoint and totally different from the present (relativistic) speed concept, it is basically nothing more than an application of the obvious fact that the resultant velocity of a particle-system is the vector sum of the velocities of its components.

This absolute, physical nature of the variable speed of mass particles and of their length contraction (and their time dilation) can also be demonstrated on the basis of the physical nature of the speed of light: Since the speed of light ‘c’ is an absolute, physical characteristic, all the characteristics that are expressed as a multiple (or fraction) of this absolute characteristic, such as:

- the variable speed of mass particles v/c (e.g. $\beta = v/c = 0,8$),
- the Lorentz factor ($\gamma = 1/(1-\beta^2)^{1/2}$),
- the length contraction ($L_v = L_0/\gamma$),
- the time dilation ($T_v = \gamma T_0$),
- the relativistic mass-energy equation ($E = \gamma m_0 c^2$)

are also absolute, physical characteristics.

This means the Special Theory of Relativity is above all, an observational theory, but that the so-called ‘relativistic’ equations, like e.g. the length contraction, the time dilation and the mass-energy equation and their applications e.g. in Quantum Field Theory, describe real physical phenomena, because they are expressed in function of the absolute speed of light.

This physical nature of velocity solves the paradoxes (such as the twin paradox) that were created by the relativistic speed concept and will in my next papers automatically lead to a

clear understanding of the physical nature of ‘mass’^(xi) and ‘time’^(xii)’.

REFERENCES

-
- [1] Ohanian Hans C. “Physics Second Edition, Expanded” p 849, W.W. Norton & Company (1989).
- [2] Goldberg S. “Understanding Relativity” p 125-126, 135-136, Birkhäuser (1981).
- [3] Goldberg S. “Understanding Relativity” p 104- 105, Birkhäuser (1981).
- [4] Paul A. Tipler & Ralph A. Llewellyn “Modern Physics” p 12, W. H. Freeman and Co (2012).
- [5] Goldberg S. “Understanding Relativity” p 142, Birkhäuser (1981).
- [6] Einstein Albert “Über die spezielle und die allgemeine Relativitätstheorie” Part 1 chapter 16, Friedr. Vieweg & Sohn, Braunschweig (1916). Dutch Edition “Relativiteit Speciale en Algemene Theorie”, Het Spectrum B. V. (1978, 1997).
- [7] Goldberg S. “Understanding Relativity” p 103, Birkhäuser (1981).
- [8] Goldberg S. “Understanding Relativity” p 137, Birkhäuser (1981).
- [9] Goldberg S. “Understanding Relativity” p 130, 131, Birkhäuser (1981).
- [10] Ohanian Hans C. “Physics Second Edition, Expanded” 1004 - 1007, W.W. Norton & Co (1989).
- [11] Fishbane, Gasiorowicz, Thornton “Physics for Scientists and Engineers, with Modern Physics” p 1081 - 1083, Pearson Education Inc. (2005).
- [12] Paul A. Tipler & Ralph A. Llewellyn “Modern Physics” p 30-33, W. H. Freeman and Co (2012)
- [13] Robert J. A. Lambourne “Relativity, Gravitation and Cosmology” p 24-27, Cambridge University Press, Ney York (2010)
- [14] Goldberg S. “Understanding Relativity” p 120, Birkhäuser (1981).
- [15] Kenneth G. Denbigh “Three Concepts of Time” p 44-45, Springer-Verlag, Berlin Heidelberg New York (1981).
- [16] Wikipedia 2011.06.19

(xi) This will be analyzed in my paper on the physical nature of ‘mass’.

(xii) This will be analyzed in my paper on the physical nature of ‘time’.

-
- [17] Lincoln Don, “The inner life of quarks”, Scientific American November 2012, p 22 – 29).
- [18] Wikipedia “Speed of light” 2018-02-09
- [19] Brian Cox and Jeff Forshaw “Why does $E = mc^2$ ” p 210 – 211, Da Capo Press (2009).
- [20] Lisa Randall “Higgs Discovery – The power of empty space” p 1-2 and 11-12, The Bodly Head 2012.
- [21] Paul A. Tipler & Ralph A. Llewellyn “Modern Physics” p 690, W. H. Freeman and Co (2012).
- [22] David Bercovici “The origins of everything” Dutch Edition p 16, Yale University Press (2016).
- [23] Tim Thwaites “Will optical fibers become obsolete?” NewScientist 12 January 1991 (p. 32)
- [24] Qi-Yu Liang, Aditya V. Venkatramani, Sergio H. Cantu, Travis L. Nicholson, Michael J. Gullans, Alexey V. Gorshkov, Jeff D. Thompson, Cheng Chin, Mikhail D. Lukin, Vladan Vuletic “Observation of three-photon bound states in a quantum nonlinear medium” Science 16 Feb 2018, Volume 359, Issue 6377, pp. 783-786 DOI: 10.1126/science.aao7293.
- [25] Robert D. Klauber “Student Friendly Quantum Field Theory – Second Edition” p 95-98, Sandtrove Press (2013).
- [26] Jim Baggott “The Concept of Mass” The Royal Institution (RI), YouTube 7.09.2017.
- [27] Lisa Randall “Warped Passages” p 209, Penguin Books (2005).
- [28] Paul A. Tipler & Ralph A. Llewellyn “Modern Physics” p 50 – 51, W. H. Freeman and Co (2012).